



TRIO
LIGHTING FOR YOU



2021



TRIO übernimmt gegenüber Verbrauchern für alle Leuchten mit fest verbauten LEDs, die ab dem 01.04.2017 (Kaufdatum) gekauft wurden, eine freiwillige LED-Funktionsgarantie von 5 Jahren und für alle Leuchten mit fest verbauten LEDs, die vor dem 01.04.2017 gekauft wurden, eine freiwillige LED-Funktionsgarantie von 3 Jahren. Nähere Informationen hierzu finden Sie in der Garantieerklärung auf unserer Internetseite.
www.trio-leuchten.de

TRIO takes on a voluntary LED functional warranty of 5 years to consumers of lamps with integrated LEDs bought on or after 01/04/2017 (purchase date), and 3 years for lamps with integrated LEDs bought before 01/04/2017. For further information, please visit our website.
www.trio-lighting.com

TRIO offre aux consommateurs une garantie volontaire de fonctionnement de 5 ans pour toutes les luminaires à LED intégrées achetées après le 01.04.2017 (date d'achat), et de 3 ans pour toutes les luminaires à LED intégrées achetées avant le 01.04.2017. Pour plus d'information, consultez notre site.
www.trio-lighting.com

TRIO verleent tegenover verbruikers voor alle armaturen met vast gemonteerde LED's die vanaf 01.04.2017 (aankoopdatum) werden gekocht, een vrijwillige LED-functiegarantie van 5 jaar en voor alle armaturen met vast gemonteerde LED's die voor 01.04.2017 werden gekocht, een vrijwillige LED-functiegarantie van 3 jaar. Voor meer informatie, consulteer onze website.
www.trio-lighting.com

TRIO ofrece a sus consumidores una garantía voluntaria de servicio de los LED de 5 años de duración para todas las lámparas con LED fijos adquiridas a partir del 01.04.2017 (fecha de compra) y de 3 años de duración para todas las lámparas con LED fijos adquiridas antes del 01.04.2017. Para más información, por favor visite nuestra página web.
www.trio-lighting.com

Ai consumatori, TRIO offre su tutti gli apparecchi sui quali sono montate sorgenti LED integrate, acquistate a partire dal 01/04/2017 (data di acquisto), una garanzia commerciale di funzionamento di 5 anni per gli apparecchi LED e su tutti gli apparecchi sui quali sono montate sorgenti LED integrate acquistate prima del 01/04/2017 una garanzia commerciale di funzionamento di 3 anni per gli apparecchi LED. Per ulteriori informazioni, vi preghiamo di visitare il nostro sito web.
www.trio-lighting.com

TRIO ofera consumatorilor o garantie comerciala de 5 ani, pentru toate corpurile de iluminat cu LED-uri incorporate, care au fost vândute începând cu 01.04.2017 (data achiziției), și pentru toate corpurile de iluminat cu LED-uri incorporate, care au fost vândute înainte de 01.04.2017, o garanție comercială de 3 ani pentru funcționarea LED-urilor. Pentru mai multe detalii, va rugăm să vizitați site-ul TRIO.
www.trio-lighting.com

TRIO myöntää kuluttajille vapaaehtoisen ledien toimivuustakuun. TRIO-valikoiman valaisimissa, joissa on kiinteästi asennetut ledit ja jotka on ostettu 1.4.2017 jälkeen (hankintapäivä), ledien takuu-aika on 5 vuotta. Valaisimissa, joissa on kiinteästi asennetut ledit ja jotka on ostettu ennen 1.4.2017, ledien takuu-aika on 3 vuotta. Lisätietoja verkkosivuiltamme.
www.trio-lighting.com

TRIO udziela konsumentom na wszystkie lampy z asortymentu TRIO z zamontowanymi na stałe diodami LED, które zakupione zostały od dnia 01.04.2017 r. (data zakupu), dobrowolnej gwarancji na działanie diod LED na okres 5 lat i na wszystkie lampy z zamontowanymi na stałe diodami LED, które zakupione zostały przed dniem 01.04.2017 r., dobrowolnej gwarancji na działanie diod LED na okres 3 lat. Na naszej stronie internetowej może Państwo uzyskać więcej informacji na ten temat.
www.trio-lighting.com

Inhaltsverzeichnis

General Index · Index général · Algemene index ·
Índice general · Indice generale · Index general · Yleisindeksi · Ogólny indeks

Unternehmen · Company Entreprise · Onderneming · Empresa · Azienda · Compania · Yritys · Przedsiębiorstwo	4
Smarte Lichtsteuerung · smart lighting control contrôle d'éclairage intelligent · slimme lichtregeling · control de iluminación inteligente · controllo intelligente dell'illuminazione · control inteligent al iluminatului · älykäs valaistuksen ohjaus · Inteligentne sterowanie światłem	36
Leuchtenfamilien & Kombinationen · Families & coordinates Familles & coordonnés · Families & combinaties · Familias & coordinados · Famiglie & coordinati · Famillii & Coordonate · Tuoteperheet & yhdistettävät tuotteet · Rodzinne orawy & kombinacje	76
Leuchten im Vintage Stil · Vintage style luminaires Luminaire style Vintage · Armaturen in Vintage stijl · Lámparas vintage · Apparecchi stile vintage · Corpi di illuminat vintage · Vintage valaisimet · Lampy w stylu vintage	234
Pendelleuchten & Kronen · Pendants & chandeliers Lustres & suspensions · Hanglampen & kroonluchters · Colgantes y Lámparas · Lampadari e sospensioni · Lustre si pendule · Riippu- & kruunu · Wiszące i żyrandole	282
Wand- und Deckenleuchten · Wall & Ceiling lamps Applique & plafonniers · Wandlampen & plafonnières · Appliques y plafones · Applique e plafoniere · Plafoniere si aplice · Seinä- & katto · Sufitowe i ścienne	338
Unterbauleuchten · Cabinet lighting Éclairage cuisine et dressing · Keuken- en kastverlichting · Iluminación de cocina y vestidor · Illuminazione cucina e spogliatoio · Iluminat pentru bucatarie si dressing room · Keittiö valaistus · Oprawy meblowe	472
Steh- und Tischleuchten · Table- & floor lamps Lampes de table & lampadaires · Tafel- & vloerlampen · Sobremesas y lámparas de pie · Lampade da tavolo e piantane · Veioze si lampadare · Pöytä- & lattia · Stołowe i podłogowe	478
DUOline 2-Phasen-Schienensystem (230 V) · 2-phase track system (230 V) Système de voie à deux phases (230 V) · 2-fase-spoorsysteem (230 V) · Sistema de rieles en 2 fases (230 V) · Sistema a binario bifase (230 V) · Sistem de piste cu 2 faze (230 V) · 2-vaihekiskojärjestelmä (230 V) · 2-fazowy system prowadnic (230 V)	558
Spotserien · Spots Spotterie · Spots · Focos · Faretti · Spoturi · Spotit · Reflektorki	574
Einbauleuchten · Recessed spots Spots encastrés · Inbouwspots · Focos empotrables · Faretti incasso · Spoturi incastrate · Uputetut spotit · Oprawy wbudowane	618
Badezimmerleuchten · Bathroom lighting Éclairage salle de bains · Badkamer verlichting · Iluminación de cuarto de baño · Illuminazione per bagno · Iluminat baie · Kylpyhuone valaistus · Oświetlenie łazienkowe	638
Leuchtmittel · Light sources Ampoules · Lichtbronnen · Fuentes de luz · Lampadine · Becuri · Valonlähteet · Źródła światła	658
Spezifikationen · Specifications Spécifications · Specificaties · Especificaciones · Specifiche · Specificații · Tekniset tiedot · Specyfikacje	674
Kontakt · Contact Contact · Contact · Contactar · Contatto · Contact · Yhteydenotto · Kontakt	702

Unternehmen

Company · Entreprise · Onderneming · Empresa · Azienda · Compania · Yritys · Przedsiębiorstwo

TRIO Leuchten wurde im Jahr 1991 im sauerländischen Arnsberg gegründet. Heute - fast 30 Jahre später - zählt unser Unternehmen zu den führenden Spezialisten für dekorative Wohnraumbelichtung.

Innovative Produktideen, ein hohes Maß an Flexibilität und die stets kundenorientierte Denk- und Handlungsweise, sind die Säulen unseres Erfolges.

Zur TRIO Lighting Group herangewachsen, beschäftigen wir aktuell rund 270 Mitarbeiter und agieren in über 30 Ländern. Dazu zählen Joint Ventures in Italien, Spanien und Skandinavien.

Ein besonderer Meilenstein in unserer Erfolgsgeschichte, ist der Bau des neuen Firmensitzes in Voßwinkel, den wir Ende 2019 mit Stolz bezogen haben.

Auf einer überbauten Fläche von rund 30.000 m² sind ein neues Verwaltungsgebäude, und ein hochmodernes Logistikzentrum mit einer Lagerkapazität von 45.000 Palettenstellplätzen entstanden.

Wir sehen einer spannenden Zukunft - mit zusätzlichem Raum für neue Herausforderungen - entgegen, und freuen uns auf Ihren Besuch.

TRIO Leuchten was founded in 1991 in Arnsberg, Sauerland. Today - getting on for almost 30 years later - our company is one of the leading specialists for decorative home lighting.

Innovative product ideas, a high degree of flexibility and the constant customer-oriented way of thinking and acting are the pillars of our success.

About TRIO Lighting Group we currently employ around 270 people and operate in over 30 countries. These include joint ventures in Italy, Spain and Scandinavia. A notable milestone in our success story is the construction of the new company headquarters in Voßwinkel, which, at the end of 2019, we proudly moved into. A new administration building and a state-of-the-art logistics center with a storage capacity of 45,000 pallet spaces have been built on a covered area of around 30,000 m².

We are heading for an exciting future - with additional room for new challenges - and look forward to your visit.

TRIO Leuchten a été fondé en 1991 à Arnsberg, dans le Sauerland. Actuellement, près de 30 ans plus tard, notre société est l'un des principaux spécialistes de l'éclairage décoratif de logements.

Des idées de produits innovantes, un haut degré de flexibilité et une façon de penser et d'agir orientée en tout temps vers le client sont les piliers de notre succès.

Devenu TRIO Lighting Group au fil des années, nous employons actuellement environ 270 collaborateurs et opérons dans plus de 30 pays, dont des joint-ventures en Italie, en Espagne et en Scandinavie.

La construction du nouveau siège de l'entreprise à Voßwinkel, où nous avons fièrement emménagé fin 2019, constitue un jalon particulier de notre réussite. Un nouveau bâtiment administratif et un centre

logistique ultra-moderne d'une capacité de stockage de 45 000 emplacements de palettes ont été construits sur une superficie d'environ 30 000 m². Nous envisageons l'avenir avec confiance et passion, avec amplement d'espace d'expansion pour faire face aux nouveaux défis. Nous nous réjouissons de votre visite.

TRIO Leuchten werd in 1991 opgericht in Arnsberg in het Sauerland.

Vandaag, bijna dertig jaar later, is onze onderneming een van de toonaangevende specialisten voor decoratieve woonruimteverlichting.

Innovatieve productideeën, een hoge mate aan flexibiliteit en de steeds klantgerichte denk- en handelingswijze liggen aan de basis van ons succes.

Uitgegroeid tot de TRIO Lighting Group stellen we momenteel ongeveer 270 medewerkers te werk en zijn actief in meer dan 30 landen.

Daarbij horen joint ventures in Italië, Spanje en Scandinavië. Een bijzondere mijlpaal in ons succesverhaal is de bouw van onze nieuwe hoofdkantoor is Voßwinkel dat we eind 2019 met trots in gebruik genomen hebben. Op een bebouwd terrein van 30.000 m² zijn een nieuw administratief gebouw en een hypermodern logistiek centrum met een opslagcapaciteit voor 45.000 pallets ontstaan. We kijken uit naar een spannende toekomst, met extra ruimte voor nieuwe uitdagingen en verheugen ons op uw bezoek.

TRIO Leuchten se fundó en 1991 en Arnsberg, Sauerland. En la actualidad, casi 30 años después, nuestra empresa es uno de los principales especialistas en iluminación decorativa para el hogar.

Los pilares de nuestro éxito son nuestras innovadoras ideas de productos, un alto grado de flexibilidad y una forma de pensar y actuar orientada constantemente al cliente.

Acerca de nosotros TRIO Lighting Group Actualmente contamos con una plantilla de 270 trabajadores y estamos presentes en más de 30 países. Además, formamos parte de empresas mixtas en Italia, España y Escandinavia. Un hito señalado en nuestra historia de éxito fue la construcción de la nueva sede de la empresa en Voßwinkel, a la que nos mudamos llenos de orgullo a finales de 2019. Levantamos un nuevo edificio administrativo y un moderno centro logístico con una capacidad de almacenamiento de 45 000 palés sobre una superficie cubierta de unos 30 000 m². Nos espera un futuro emocionante en este espacio adicional para nuevos desafíos en el que estaremos encantados de recibir su visita.



TRIO Leuchten è stata fondata nel 1991 ad Arnsberg, Sauerland. Oggi, a distanza di quasi 30 anni, la nostra azienda si colloca tra gli specialisti leader nel settore dell'illuminazione decorativa per la casa.

Idee di prodotto innovative, un'elevata flessibilità e un modo di pensare e di agire costantemente orientato al cliente sono le pietre miliari del nostro successo.

Il Gruppo TRIO Lighting, conta attualmente circa 270 dipendenti e opera in oltre 30 paesi, tra cui Joint Venture in Italia, Spagna e Scandinavia. Una importante pietra miliare nella nostra storia di successo è la costruzione della nuova sede aziendale a Voßwinkel, nella quale ci siamo trasferiti con orgoglio alla fine del 2019. Su un'area edificata di circa 30.000 m² sono stati costruiti un nuovo edificio amministrativo e un modernissimo centro logistico con una capacità di stoccaggio di 45.000 posti pallet. Confidiamo in un futuro entusiasmante - con uno spazio più ampio per affrontare nuove sfide - e attendiamo con impazienza la vostra visita.

TRIO Leuchten perustettiin vuonna 1991 Arnsbergissa, Sauerlandin alueella Saksassa. Tänäään – lähes 30 vuotta myöhemmin – yrityksemme on yksi johtavista olohuoneiden valaistusasiantuntijoista.

Innovatiiviset tuoteideat, hyvä joustavuus ja aina asiakaslähtöinen ajattelutapa ja toiminta ovat menestyksemme peruspilareita.

Kasvettuamme TRIO Lighting -konserniksi työllistämme tällä hetkellä noin 270 ihmistä ja toimimme yli 30 maassa. Tähän sisältyvät yhteisyritykset Italiassa, Espanjassa ja Skandinaviassa. Erityinen virstanpylväs menestystarinassamme oli uuden yrityksen pääkonttorin rakentaminen Voßwinkeliin. Otimme sen suurella mielenkiinnolla käyttöön vuoden 2019 lopulla. Noin 30 000 m² alueelle on rakennettu uusi hallintorakennus ja huipputekninen logistiikkakeskus, jonka varastotilavuus on 45 000 kuormalavaa. Odotamme mielenkiintoista tulevaisuutta – saatuamme lisätilaa uusille haasteille – ja odotamme myös vierailuasi.



TRIO Leuchten a fost înființată în anul 1991 în localitatea Arnsberg din Sauerland, Germania. Astăzi - la aproape de 30 de ani distanță - compania noastră este unul dintre specialiștii noștri de top pentru iluminat decorativ al spațiilor de locuit.

Ideii inovatoare de produs, un grad ridicat de flexibilitate și un mod de gândire și acțiune orientat în permanență către client reprezintă fundația succesului nostru.

Referitor la Grupul TRIO Lighting ca urmare a unei creșteri sănătoase, dispunem acum de un număr de 270 de angajați și suntem activi în 30 de țări. Acestea includ joint ventures în Italia, Spania și Scandinavia. Un punct de cotitură deosebit al poveștii succesului nostru este construcția noii noastre centrale de companie la Voßwinkel, pe care cu mândrie am dat-o în funcțiune la finalul anului 2019. Pe o suprafață construită de 30.000 m² se regăsește o nouă clădire administrativă și un centru logistic ultramodern cu o capacitate de depozitare de 45.000 poziții de depozitare paleți. Privim către un viitor palpitant - cu spațiu pentru noi provocări - și ne bucurăm de vizita dvs.

TRIO Leuchten została założona w 1991 roku w Arnsberg, Sauerland. Dziś - prawie 30 lat później - nasza firma jest jednym z wiodących specjalistów w zakresie dekoracyjnego oświetlenia domu.

Innowacyjne produkty, duża elastyczność oraz nieustanna orientacja na klienta w sposobie myślenia i działania to filary naszego sukcesu.

Informacje na temat TRIO Lighting Group obecnie zatrudniamy około 270 pracowników w ponad 30 krajach. Posiadamy m.in. spółki joint venture we Włoszech, Hiszpanii i Skandynawii. Przełomowym osiągnięciem w naszej działalności była budowa nowej siedziby naszej firmy w Voßwinkel, do której przeprowadziliśmy się pod koniec 2019 roku. Na zadanej powierzchni około 30 000 m² zbudowano nowy budynek administracyjny i nowoczesne centrum logistyczne o pojemności 45 000 miejsc paletowych. Nasza przyszłość rysuje się kolorowo. Jesteśmy otwarci na nowe wyzwania i czekamy na Wasze odwiedziny.

Serienübersicht

Family overview · Aperçu par famille · Overzicht per familie ·

Vista general por familia · Panoramica per famiglia · Prezentare pe familii de produse ·

Perheen yleiskuvaus · Przegląd rodziny

AARON	44	BOSTON	326	COMPTON	87	DIVO	468	GINELLI	198
ABERDEEN	457	BOWIE	602	COMTESS	414	DOLOMITE	632	GINSTER	310
ADRIAN	416	BRAD	236	CONCHA	442	DOLPHIN	368	GOA	592
ADRIANA	64	BRIAN	640	CONCRETE	600	DONNA	546	GONZALO	406
ADRIANO	458	BULTO	417	CONDOR	404	DOVER	312	GOTHAM	268
AGENTO	136	BUSA	422	CONDUS	656	DRAGON	389	GRANADA	366
ALEGRO	300	CAFU	92	CONNOR	210	DUOLINE	560	GRANDE	535
ALICIA	182	CALAIS	312	CONO	469	DURBAN	288	GRIFFIN	54
ALINO	475	CALCIO	500	CONTENDER	407	DYLAN	646	HARRIET	340
ALOFT	434	CALVARO	298	CONTRAST	404	ECCO	477	HENK	552
AMSTERDAM	528	CAMPO	469	CONVERTER	407	EDDA	274	HOLLY	305
ANDREUS	154	CANDELA	317	COOKIE	380	EDMONTON	488	HOSTEL	156
APART	655	CANNES II	509	CORD	266	EDWARD	224	HOTEL	148
ARAGON	475	CAPITAL	209	CORE	631	ELEMENT	435	HOUSTON	617
ARANGO	493	CARBONADO	421	CORLAND	386	ELMAU	260	HYDRA	356
ARIZONA	492	CARICO	606	CORLAND II	298	EMBASSY	427	IBIS	160
ARY	554	CARL	608	CORMINT	420	EMERALD	549	ICARO	506
ASTRID	274	CARLA	328	CORTEZ	320	ENRICO	458	IMARA	58
AURA	629	CARLO	440	COSINUS	145	ESCALATE	454	INDIRA	360
AURORA	428	CARLOTTA	328	COVENTRY	302	EVA	324	IRIS	462
AVIGNON	588	CARRERA	82	CRISTO	550	FACELLA	469	IRVINE	354
AVUS	106	CATOKI	125	CROSS	216	FARO	166	IVAR	240
BAJO	335	CAVALLO	293	CUADRO	430	FERNANDO	382	JACOB	279
BALDO	464	CENTO	411	CUBA	576	FIGO	65	JAMIRO	308
BALINI	186	CESAR	408	CUBE	459	FILIGRAN	504	JANKO	252
BALOUBET	134	CHARIVARI	116	CURL	286	FISHERMAN	275	JASMIN	281
BANGKOK	480	CHARLY	58	CURTIS	431	FLEXO	545	JASPER	226
BARON	114	CHIBA	403	CURVA	418	FLORESTAN	484	JOHANN	278
BARONESS	108	CHICO	422	DAMIAN	70	FLORIS	421	JONES	616
BARRIE	486	CHIROS	429	DAVI	554	FORESTER	253	JOOST	551
BASIC	589	CHRIS	132	DELHI	242	FRANCIS	78	JORDAN	436
BELFAST	96	CHRISTOBAL	204	DELIA	329	FRED	470	JUDITH	265
BERGAMO	502	CITIZEN	50	DETROIT	228	FREDDY	612	JUNO	413
BERLIN	546	CLAAS	512	DIALLO	214	FUTURE	376	JURA	637
BIRTE	272	CLAPTON	578	DIAMANT	663	FYNN	553	KAZAN	498
BISCUIT	380	CLARIMO	654	DIAMO	62	GALE	348	KENAI	635
BODRUM	364	CLEO	428	DICAPO	46	GARDA	158	KHAN	238
BOLDER	467	COLIN	333	DIEGO	334	GASTON	445	KIMI	542
BOLERO	448	COLINA	202	DISC	419	GEMMA	415	KINGSTON	178
BOLSA	642	COLUMBIA	378	DISCALGO	222	GENT	515	KOLANI	196
BOOLAN	314	COMPO	657	DISCUS	212	GERRIT	552	KOLIAN	650

KOLIBRI	540	MATS	556	PAGO	598	RONDO	104	TEXEL	517
LACAL	296	MATTIMO	652	PAMIR	621	ROPE	264	THIAGO	48
LACAN	555	MELBY	57	PANTILON	59	ROTIN	262	TILL	554
LACAPO	446	MELVIN	450	PAPER	336	ROTTERDAM	532	TIMBER	248
LAGOS	584	MICHAEL	604	PARIS II	522	RUBY	387	TIRIAC	128
LANA	422	MIDAS	190	PEACOCK	362	RUNA	258	TITUS	370
LANCE	526	MIGUEL	451	PENTA	414	RUSTICA	495	TOKYO	401
LAON	470	MIKO	395	PEREZ	524	SALERNO	100	TORRANCE	372
LARA	270	MINSK	316	PHOENIX	374	SAMURAI	402	TOSH	254
LENTIL	455	MIRO	468	PIET	557	SANCHO	68	TOULON	180
LEON	590	MONTENDER	332	PILATUS	586	SANDRINA	203	TRACY	518
LEVISTO	610	MONTI	550	PILLAR	497	SANNA	276	TRADITIO	232
LIÈGE	514	MOONY	426	PINDOS	627	SANTO II	494	TRAJAN	294
LIGARA	470	MORTEN	550	PIRIN	633	SAPORO	396	TRINITY	346
LILLY	462	MOSAIQUE	414	PLANT	250	SATURN	292	TRISTAN	72
LINCOLN	88	NACHO	218	PLATON	456	SEDONA	350	TRUMPET	614
LINDA	280	NADAL	530	POLLY	541	SEIKO	400	TUBULAR	284
LINE	466	NAGANO	401	POLO	541	SETA	554	TUCSON	90
LINZ	516	NALIDA	56	POLYDOR	386	SHANGHAI	482	TURNER	388
LIVARO	60	NANDOR	520	PORTO	176	SHAOLIN	394	VALENTE	188
LOGAN	84	NAPOLI	230	PORTOFINO	118	SHARK	586	VAPORE	162
LOOP	124	NARCOS	580	PRETO	540	SHOGUN	402	VARIO	534
LORELEY	318	NECTOR	74	PRIMO	423	SIGNA	200	VENTURA	551
LOTUS	394	NIKOSIA	206	PRONTO	545	SILAS	130	VERONA	503
LOUIS	449	NILO	650	PURE	194	SIMEO	473	VICTORIA	419
LUCAS	376	NINJA	392	QUEBEC	490	SOLA	485	VIEW	644
LUCERNA	164	NO.5	271	QUINTA	424	SORRENTO	94	VIOLA	333
LUGANO	140	NORA	423	RADO	536	SPIRELLI	201	VISTA	66
LUIGI	438	NORIAKI	393	RAIKO	400	SPLIT	496	VITA	468
LUIS	555	OAKLAND	80	RAMIRO	325	STAKKATO	299	WAILER	146
LUNAR	405	OGASAKI	390	RAMON	476	STAMINA	330	WALES	457
LUPO	538	OKINAWA	398	RAVEN	444	STELLA	328	WIM	557
LYON	138	OLYMPUS	122	RAY	648	SUBARA	343	XAVI	648
MACAU	290	ONTARIO	172	REPOSA	425	SUZUKA	344	ZAGROS	623
MADEIRA	170	ONYX	322	RHEA	412	SWEETY	208	ZANDOR	112
MADRAS	246	ORCHESTRA	220	RILA	625	SYDNEY	120	ZAZOU	460
MARIO	438	OSAKA	397	ROBIN	192	TAJO	544	ZEUS	410
MARIUS	126	OSCAR	52	RODDIK	306	TANDORI	510	ZIDANE	507
MARLEY	594	OTTAWA	324	RODERIC	537	TANJA	277	ZITA	432
MARRIOT	439	OVIEDO	460	ROMA	460	TATRA	463	ZORRO	452
MARTA	468	OXFORD	358	ROMINO II	324	TAURUS	384	ZUCCA	335

Pendelleuchten & Kronen

Pendants & chandeliers · Lustres & suspensions · Hanglampen & kroonluchters · Colgantes y Lámparas · Lampadari e sospensioni · Lustre si pendule · Riippu- & kruunu · Wiszące i żyrandole



VAPORE 162



FARO 166



ONTARIO 172



PORTO 176



ONTARIO 174



ONTARIO 174



VALENTE 188



ALICIA 182



MIDAS 190



CALAIS 312



DOVER 312



BALINI 186



GINSTER 310



ROBIN 192



KOLANI 196



TRISTAN 72



DAMIAN 70



PURE 194

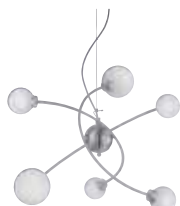

DICAPO 46



MINSK 316



LUCERNA 164



CHRISTOBAL 204



SIGNA 200



SPIRELLI 201



VIOLA 333



COLIN 333



MONTENDER 332



CARBONADO 332



DIEGO 334



SWEETY 208



BARON 114



ZANDOR 112



BARONESS 108



OTTAWA 324



BOSTON 326



JASPER 226



CANDELA 317



ORCHESTRA 220

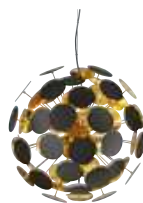

DISCALGO 222



EDWARD 224



ROMINO II 324



EVA 324



KINGSTON 178



TOULON 180



GINELLI 198



TRUMPET 327



SANDRINA 203



COLINA 202



NIKOSIA 206



CHRIS 132



HOLLY 305



CAPITAL 209



ONYX 322



RAMIRO 325



Pendelleuchten & Kronen

Pendants & chandeliers · Lustres & suspensions · Hanglampen & kroonluchters · Colgantes y Lámparas · Lampadari e sospensioni · Lustre si pendule · Riippu- & kruunu · Wiszące i żyrandole



BRAD 236



KHAN 238



DEHLI 242



IVAR 240



RUNA 258



TOSH 254



JOHANN 278



SANNA 276



TANJA 277



JACOB 279



JUDITH 265



ASTRID 274



CONNOR 210



DISCUS 212



CROSS 216



NACHO 219



CORD 267



BOOLAN 314



ELMAU 260



WAILER 146



GARDA 158



LUGANO 140



COSINUS 144



CORTEZ 320



JAMIRO 308



RODDIK 306



ZUCCA 335



BAJO 335



PAPER 336



DELIA 329



STELLA 328



CARLA 328



CARLOTTA 328



MARLEY 572



ONTARIO 572





MADRAS 246



PLANT 250



FORESTER 253



TIMBER 249



GOTHAM 268



BIRTE 272



BIRTE 273



FISHERMAN 275



EDDA 274



JASMIN 281



ROTIN 262



NAPOLI 230



TRADITIO 232



DETROIT 228



IBIS 160



LORELEY 318



HOTEL 148



HOSTEL 156



ANDREUS 154



DUline TRACK-SYSTEM

JIMMY 572



DUline TRACK-SYSTEM

HOTEL 570

Pendelleuchten & Kronen

Pendants & chandeliers · Lustres & suspensions · Hanglampen & kroonluchters · Colgantes y Lámparas · Lampadari e sospensioni · Lustre si pendule · Riippu- & kruunu · Wiszące i żyrandole

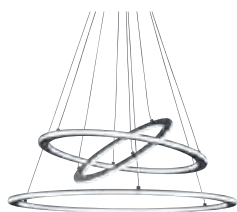

DURBAN 288



MACAU 290



SATURN 292

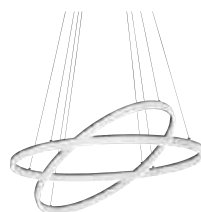

LINCOLN 89

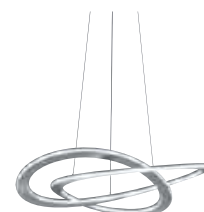

OAKLAND 80



CARRERA 82



AARON 44



FRANCIS 78



LOGAN 84



TIRIAC 128



RONDO 104

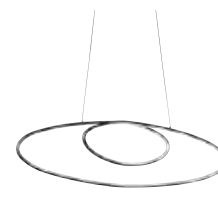

AVUS 107



CURL 286



CHARIVARI 116



AGENTO 136

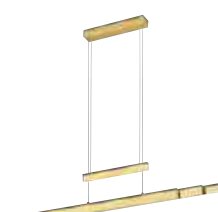

TRAJAN 294

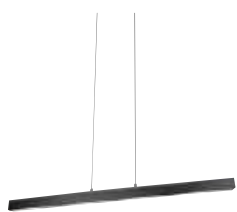

BELFAST 96



SALERNO 100



COVENTRY 302

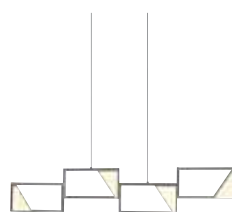

CAFU 92

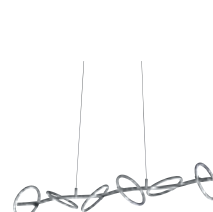

OLYMPUS 122



SYDNEY 121



MARIUS 126



SILAS 130



LIVARO 60



CAVALLO 293



STAKKATO 299



LACAL 296

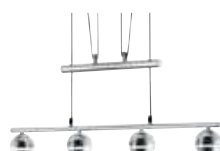

BALOUBET 134



FREDDY 612



LEVISTO 610



STAMINA 330



ALEGRO 300



CORLAND II 298



CARICO 606



COMPTON 86



TUBULAR 284

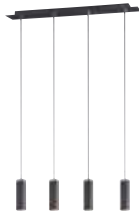

MARLEY 594

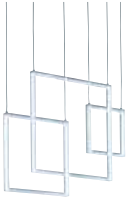

TUCSON 90

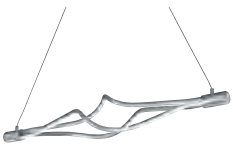

LOOP 124



PORTOFINO 118



CALVARO 298



Deckenleuchten

Ceiling lamps · Plafonniers · Plafonnières · Plafones ·
Plafoniere · Plafoniere · Kattvalaisimet · Plafony



CARRERA 82



FRANCIS 78



LOGAN 84



SORRENTO 94



AARON 44



THIAGO 48



OSCAR 52

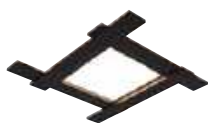

BELFAST 96



SALERNO 100



GALE 348



SEDONA 350



LINCOLN 88



OLYMPUS 122



BODRUM 364



OAKLAND 80



RUBY 387



PORTOFINO 118



SYDNEY 120



TUCSON 352



SEDONA 353



IRVINE 354

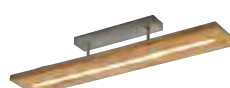

BRAD 236

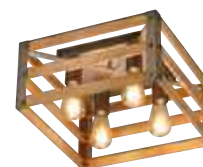

KHAN 238



HARRIET 340



CHARIVARI 116



GRANADA 366



DOLPHIN 368



EDWARD 224



OCHESTRA 220



HOTEL 151



LUGANO 142



DIAMO 62



EMBASSY 427



HOTEL 150



HOSTEL 156



AGENTO 136



GARDA 158

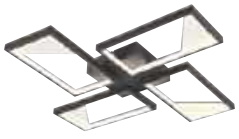

CAFU 92



HYDRA 356



RONDO 104



AVUS 106



CITIZEN 50

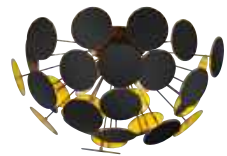

DISCALGO 222



MOONY 426



IBIS 160



Deckenleuchten

Ceiling lamps · Plafonniers · Plafonnières · Plafones ·
Plafoniere · Plafoniere · Kattvalaisimet · Plafony



TRINITY 346



SUBARA 342



SUZUKA 344



DICAPO 46



OSAKA 397



NINJA 392



COLUMBIA 378



LUCAS 376



CHIBA 403



IMARA 58



SILAS 130



LIVARO 60



LOTUS 394



SEIKO 400



RAIKO 400



CONTRAST 404



CESAR 408



CONDOR 404



CHARLY 58



NALIDA 56



SHAOLIN 394



SAPORO 396



TITUS 370



JUNO 413

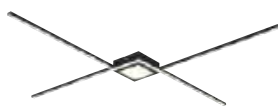

OXFORD 358

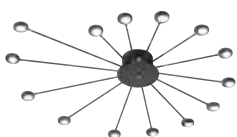

PEACOCK 362



BARON 114



ZANDOR 112



BARONESS 110



FERNANDO 382



TUCSON 90



TIRIAC 128



INDIRA 360



TURNER 388



DRAGON 389



MELBY 57



KOLANI 196



GINELLI 198



CARICO 606



BALOUBET 134



CLAPTON 578



CURVA 418



OGASAKI 390



NORIAKI 393



TOKYO 401



MIKO 395



OKINAWA 398



FUTURE 376



GRIFFIN 54



TORRANCE 372



PHOENIX 374



CONVERTER 407



CONTENDER 407



LUNAR 405



SAMURAI 402



SHOGUN 402



RHEA 412



CENTO 411



ZEUS 410



GONZALO 406



COOKIE 380



BISCUIT 380



CATOKI 125

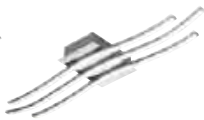

CATOKI 125



CORLAND 386



POLYDOR 386

Deckenleuchten

Ceiling lamps · Plafonniers · Plafonnières · Plafones ·
Plafoniere · Plafoniere · Kattvalaisimet · Plafony



VALENTE 188



ALICIA 182



FARO 166



VAPORE 162



DISC 419



VICTORIA 419



NACHO 218



CROSS 216



TRADITIO 232



DIALLO 214



DISCUS 212



CUBE 459



CHIROSO 429



COMTESS 414

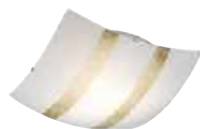

NIKOSIA 206



PENTA 414



MOSAIQUE 414



CHRISTOBAL 204



CORMINT 420



ADRIAN 416



BULTO 417



BUSA 422



PRIMO 423



CHICO 422



BOLSA 642



DYLAN 646



APART 655



CLARIMO 654



CONDUS 656



AURA 629



CORE 631



PINDOS 627



ZAGROS 623



ZAGROS 623



PAMIR 621



JURA 637



JURA 637



COMPO 657



DOLOMITE 632



PIRIN 633



TATRA 463



REPOSA 425



NAPOLI 230



RUSTICA 424



QUINTA 424



JOHANN 278



LILLY 462



IRIS 462



SIGNA 200



SPIRELLI 201

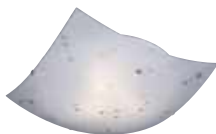

COLINA 202



SANDRINA 203



GEMMA 415



CARBONADO 421



FLORIS 421



NORA 423



LANA 422



SWEETY 208



PAMIR 621



RILA 625



RILA 625



KENAI 635



TATRA 463



HOTEL 570



LED-PANEL 573

Wandleuchten

Wall lamps · Appliques · Wandlampen · Appliques ·
Appliques · Lămpi de perete · Seinävalaisimet · Science

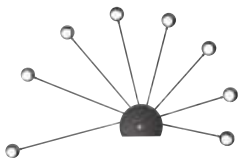

PEACOCK 362



BELFAST 96



ADRIANA 64



MIGUEL 451

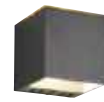

FIGO 65



RAVEN 444



ZANDOR 112



ZORRO 452



ABERDEEN 457



ADRIANO 458



ESCALATE 454



LACAPO 446



MARLEY 597



SANCHO 68



LENTIL 455



VISTA 66



ENRICO 458



CUBE 459



MADEIRA 170



MARRIOT 439



LOUIS 449



BOLERO 448



ANDREUS 154

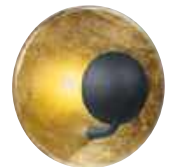

AURORA 428



BRAD 236



KHAN 238



DIALLO 214



NACHO 218



NAPOLI 230



DETROIT 228



BOLDER 466



LINE 466



EDWARD 224



KAZAN 498



CALCIO 500



CURTIS 431



GOTHAM 268



CAMPO 469



FACELLA 469



CONO 469



ZITA 432



CONCHA 442



WALES 457



MELVIN 450



ROMA 460



ZAZOU 460



OVIEDO 460



CHIROS 429



CLEO 428



TRADITIO 232



LUCERNA 164



CUADRO 430

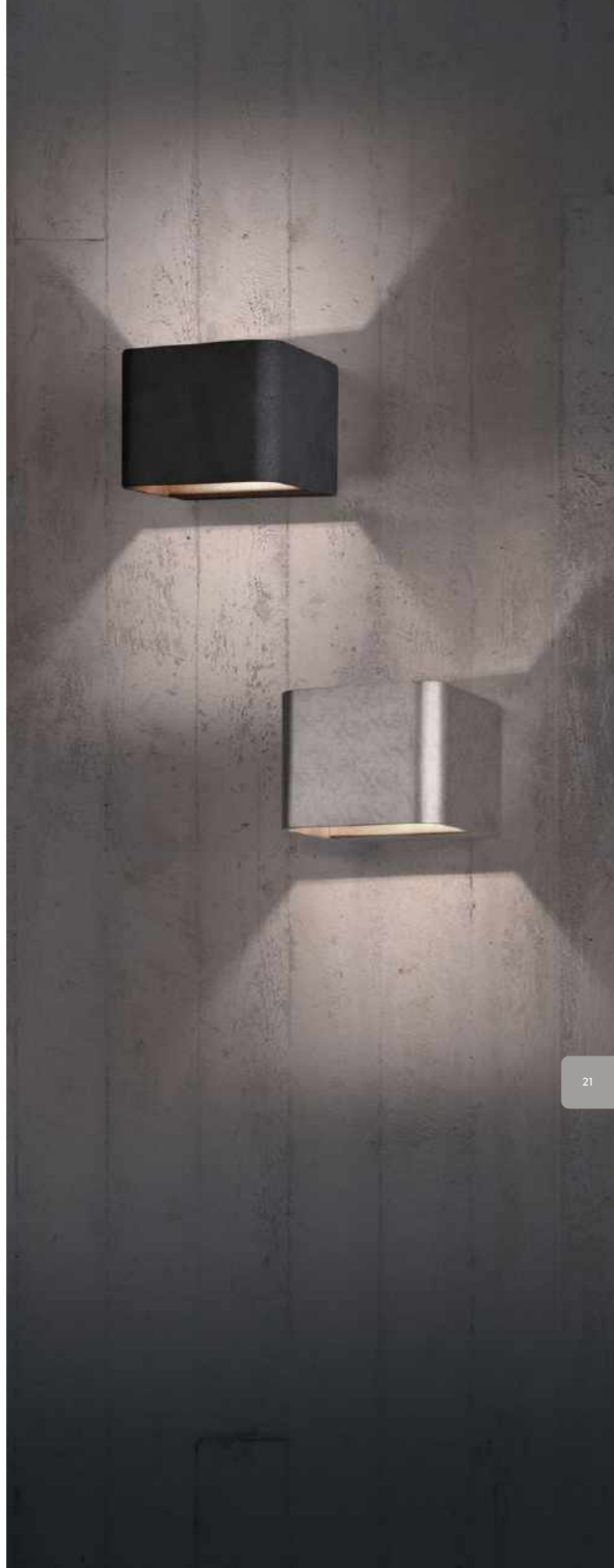

Wandleuchten

Wall lamps · Appliques · Wandlampen · Appliques ·
Appliques · Lämpi de perete · Seinävalaisimet · Science



GASTON 445



JORDAN 436



ELEMENT 435



TRINITY 346



CARLO 440



SUBARA 342



MARIO 438



LUIGI 438



ALOFT 434



LUGANO 140



HOTEL 152



BALDO 464



LYON 138



AGENTO 136



PURE 194



TRISTAN 72



MIRO 468



TOULON 180



VITA 468



SIGNA 200



CHRISTOBAL 205



CORMINT 420



SWEETY 208



COLINA 202



SANDRINA 203



SPIRELLI 201



NIKOSIA 206



BRIAN 640



BOLSA 642



RAY 648



DYLAN 646



MATTIMO 652



KOLIAN 650



NILO 650



SIMEO 473



ARAGON 475



ALINO 475



RAMON 476



ECCO 477



PLATON 456



MARIUS 126



DIVO 468



MARTA 468



CARBONADO 421



CAPITAL 209



XAVI 648



VIEW 644



Spotserien

Spots · Spotterie · Spots · Focos · Faretti · Spoturi · Spotit · Reflektorki



CUBA 576



NARCOS 580



CLAPTON 578



LAGOS 584



TAURUS 384



LEON 590



PAGO 598



MARLEY 594



CONCRETE 600



WAILER 146



BOWIE 603



FREDDY 612



GINELLI 198



KOLANI 196



CARICO 606



JONES 616



LEVISTO 610



TRUMPET 614



CARL 608

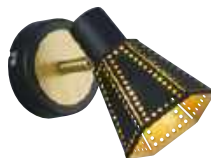

HOUSTON 617



MADRAS 246



TOSH 256



DEHLI 244



TIMBER 248



PILATUS 586



SHARK 586



AVIGNON 588



BASIC 589



BALOUBET 589



LEVISTO 471



TOMMY 571



LEON 571



MARLEY 572



ANTIBES 572



DIALLO 571



GOA 592



SANCHO 68



MICHAEL 604



LAON 471



FRED 471



LIGARA 471

Tischleuchten

Table lamps · Lampes de table · Tafellampen · Sobremesas ·
Lampa da tavolo · Veioze · Pöytävalaisimet · Lampy stołowe



TANDORI 510



AGENTO 136



LYON 138



PARIS II 522



NANDOR 520



HOSTEL 156



ANDREUS 154



MATS 556



WIM 557



PIET 557



COSINUS 144



HOTEL 149



VAPORE 163



FARO 167



ALICIA 182



PORTO 177



MIDAS 190



ROBIN 192



DICAPO 46



JOOST 551



VENTURA 551



LUIS 555



SETA 554



ARY 554



HENK 552



DONNA 546



EMERALD 549



FYNN 553



MORTEN 550



TILL 554



ELMAU 260



TOSH 257



JANKO 525



ROTIN 262



GOTHAM 268



ASTRID 274



LARA 270



JASMIN 281



LINDA 280



TRADITIO 232



JAMIRO 308



TEXEL 517



LIÈGE 514



GARDA 158



DAMIAN 70



KINGSTON 178



GERRIT 552



CAPITAL 209



LACAN 555



DAVI 554



CRISTO 550



MONTI 550



BIRTE 272



DIALLO 214



Tischleuchten

Table lamps · Lampes de table · Tafellampen · Sobremesas ·
Lampa da tavolo · Veioze · Pöytävalaisimet · Lampy stołowe



CHARIVARI 116



PURE 194



BERLIN 546



CURTIS 548



BERGAMO 502



LOOP 124



SYDNEY 120



OLYMPUS 122



CATOKI 125



CATOKI 125



PORTOFINO 119



COMPTON 86



RONDO 104



CAFU 92



SORRENTO 94



BARONESS 110



NADAL 530



RADO 536



RODERIC 537



AMSTERDAM 528



ROTTERDAM 532



KAZAN 498



POLO 541



GRANDE 535



CALCIO 500



KOLIBRI 540



PRETO 540



NARCOS 581



POLLY 541



LUPO 538



KIMI 542



BALOUBET 134



FREDDY 613



JASPER 226



TAJO 544



PRONTO 545



FLEXO 545



FILIGRAN 504



VARIO 534



Stehleuchten

Floor lamps · Lampadaires · Vloerlampen · Lámparas de pie · Piantane · Lampadare · Lattiavalaisimet · Lampy podłogowe



CANNES II 509



PARIS II 522



LYON 138

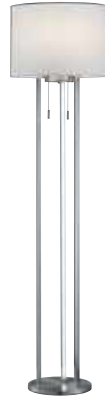

TANDORI 511



CLAAS 512



HOTEL 525



NANDOR 520



HOSTEL 156



ANDREUS 154



TRACY 518



LINZ 516



TEXEL 517



GENT 515



LIÈGE 514



CROSS 216



KHAN 238



TOSH 254



RUNA 258



IVAR 240



DEHLI 245



NO. 5 271



HOTEL 149



COSINUS 144



PEREZ 524



GOTHAM 268



JANKO 252



ROTIN 262



Stehleuchten

Floor lamps · Lampadaires · Vloerlampen · Lámparas de pie · Piantane · Lampadare · Lattiavalaisimet · Lamy podłogowe



VAPORE 162



BALINI 186



CONNOR 210



ALICIA 182



LANCE 526



DIALLO 214



SALERNO 100



CAFU 92



SORRENTO 94



RONDO 104



AVUS 106

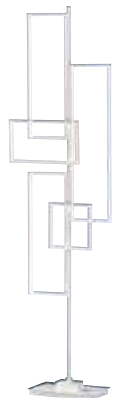

TUCSON 91



BARONESS 109

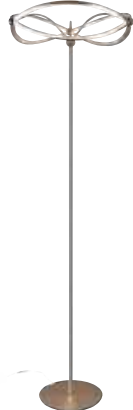

CHARIVARI 116



OAKLAND 80



PORTOFINO 118



LOOP 124



MARIUS 126



CHRIS 133

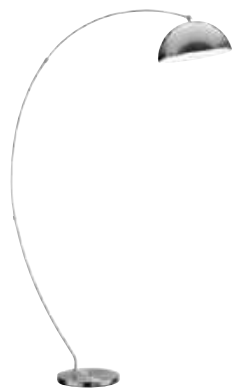

FLORESTAN 484

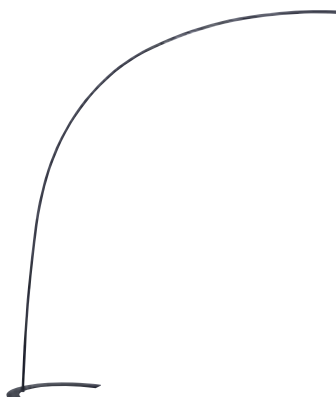

SHANGHAI 482



BANGKOK 480



SOLA 485

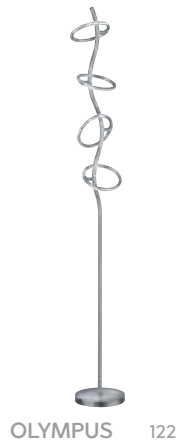

Stehleuchten

Floor lamps · Lampadaires · Vloerlampen · Lámparas de pie ·
Piantane · Lampadare · Lattiavalaisimet · Lampy podłogowe



BARRIE 486



EDMONTON 488



QUEBEC 490



SPLIT 496



SANTO II 494



ARIZONA 492



KAZAN 498



CALCIO 500



BERGAMO 502



VERONA 503



JASPER 227



ICARO 506



DICAPO 47



PILLAR 497



PANTILON 59



EDWARD 224



ZIDANE 507



NARCOS 505



CONCRETE 600



LAGOS 584



GINELLI 199



ARANGO 493



CHRIS 132



RUSTICA 495



FILIGRAN 504



BALOUBET 134



FREDDY 612





Intelligente Lichtsteuerung

Intelligent light control
Commande intelligente de l'éclairage
Intelligente lichtregeling
Control inteligente de la luz
Controllo della luce intelligente
Comandă inteligentă a luminii
Älykäs valaistuksen ohjaus
Inteligentna kontrola światła

Get your light connected.

TRIO Leuchten mit WiZ-Technologie ermöglichen ein faszinierendes und innovatives Lichtdesign, das sich vollkommen individuell steuern, programmieren und kontrollieren lässt.

Die smarte Lichtsteuerung liefert dabei unbegrenzte Möglichkeiten für jeden Anlass die gewünschte Atmosphäre zu kreieren - ob per App, Sprachsteuerung, Fernbedienung und den herkömmlichen Wandschalter.

TRIO luminaires with WiZ technology enable fascinating and innovative lighting settings that can be individually managed, programmed and controlled.

The smart lighting control provides unlimited possibilities to create the desired atmosphere for every occasion - whether via app, voice control, remote control and the conventional wall switch.

Les luminaires TRIO sont dotés de la technologie WIZ. Celle-ci permet une mise en scène fascinante et innovante. Chaque éclairage peut être géré, programmé et contrôlé individuellement.

Le contrôle d'éclairage intelligent offre d'immenses possibilités (ou d'inombrables possibilités). Il permet de créer des atmosphères différentes pour chaque occasion via l'application, le contrôle vocal, la télécommande ou l'interrupteur mural.

TRIO-armaturen met WiZ-technologie maken fascinerende en innovatieve instellingen van de verlichting mogelijk die afzonderlijk kunnen worden beheerd, geprogrammeerd en geregeld.

De slimme lichtregeling biedt onbeperkte mogelijkheden om de gewenste sfeer te creëren voor elke gelegenheid - of dit nu via de app, spraakbesturing, afstandsbediening en de conventionele wandschakelaar is.

Las luminarias TRIO con tecnología WiZ permiten configuraciones de iluminación fascinantes e innovadoras que se pueden gestionar, programar y controlar individualmente.

El control de iluminación inteligente ofrece ilimitadas posibilidades de crear la atmósfera deseada para cada ocasión- vía App, control de voz, control remoto e interruptor de pared convencional.

Gli apparecchi TRIO con tecnologia WiZ consentono impostazioni di illuminazione affascinanti e innovative che possono essere gestite, programmate e controllate individualmente.

Il controllo intelligente dell'illuminazione offre infinite possibilità di creare l'atmosfera desiderata per ogni occasione, tramite app, controllo vocale, telecomando e interruttore a muro convenzionale.

Corpurile de iluminat TRIO cu tehnologia WiZ permit setari inovative si fascinante care pot fi programate si controlate .

Controlul inteligent al iluminatului furnizeaza posibilitati nelimitate pentru a crea atmosfera dorita pentru fiecare ocazie - fie ca este prin aplicatie ,comanda vocala , telecomanda sau intrerupatorul conventional pe perete .

TRIO WiZ teknologialla varustetut valaisimet mahdollistavat lumaavan ja innovatiivisen valaistuksen jota voidaan yksilöllisesti hallinnoida, ohjelmoida ja käyttää.

Älyvalaistus mahdollistaa rajoittamattomat mahdollisuudet luoda erilaisia tunnelmatiloja jokaiseen tilanteeseen - joko appien, puhetunnistuksen, kaukosäätimen tai seinäkytkimen kautta.

Lampy TRIO w technologii WiZ umożliwiają fascynujące i innowacyjne projekty świetlne, które można doskonale sterować, programować i kontrolować w indywidualny sposób.

Inteligentne sterowanie światłem zapewnia przy tym nieograniczone możliwości kreowania pożądanej atmosfery na każdą okazję - czy to za pomocą aplikacji, sterowania głosem, pilota i konwencjonalnych przełączników ściennych.



Sensoren
Sensors



Sommer
Summer



Zeitpläne
Schedules



Warmweiß
Warm white



Tageslicht
Daylight



Momente
Moments



Party
Party



Sprachsteuerung
Voice control



Mojito
Mojito



FLEXIBLE

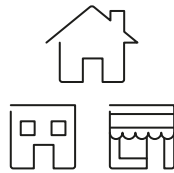

Mehrere Standorte

Kontrollieren und Steuern von mehreren Standorten gleichzeitig und von überall aus. Ob das eigene Zuhause oder die Ferienwohnung.

Multiple locations

Control and command multiple locations simultaneously and from anywhere. Whether your own home or your holiday home.

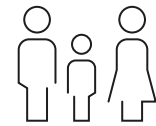

Mehrere Nutzer

Die Anzahl der Nutzer zur Steuerung der Leuchten kann individuell festgelegt werden.

Multiple user

The number of persons to control the lights can be set individually.



Cloud basiert

WiZ verbindet sich mit der Cloud, damit Vorlieben gespeichert, Wünsche geteilt und Updates automatisch generiert werden.

Cloud based

WiZ connects to the cloud to store preferences, share desires and generate updates automatically.



Mehrere Räume

Alle Leuchten können unterschiedlichen Räumen zugeordnet und präzise gesteuert werden – einzeln oder in Gruppen.

Several rooms

All lights can be assigned to different rooms and precisely controlled – individually or in groups.



Keine zusätzliche Bridge erforderlich

Es wird keine zusätzliche Bridge oder Hub für die Steuerung der Leuchten benötigt.

No additional hub needed

There is no need for an additional bridge or hub to control the lights.

SMART



Wlan Technologie

WiZ nutzt Wlan-Technologie als sichere, unabhängige, kostengünstige und einfach zu installierende Funklösung.

WiFi technology

WiZ uses Wi-Fi technology as a secure, independent, affordable and easy-to-install wireless solution.

INNOVATIVE

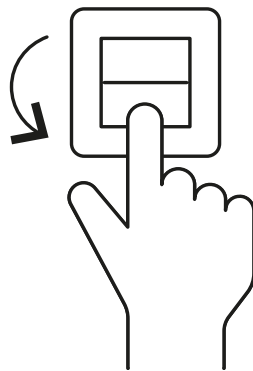

WiZ CLICK

Einfach und effektiv.
Zwei bevorzugte Lichtmodi können über den vorhandenen Lichtschalter bedient werden.

Simple and effective. Two preferred light modes can be operated via the existing light switch.

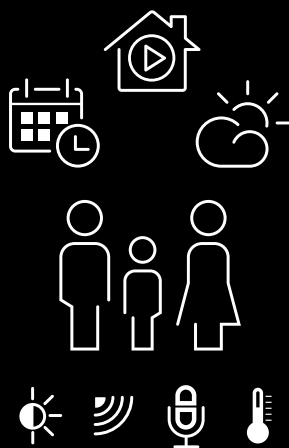

WiZ MAGIC

Steuerung der Leuchten über Zeitpläne, Sensoren oder einfache Sprachbefehle. Kompatibel mit Amazon Alexa und Google Home.

Control of the lights by time schedules, with sensors or by simple verbal commands. Compatible with Amazon Alexa and Google Home.



WiZ APP

Einfach und schnell installiert.
Volle Funktionalität und Flexibilität mit der WiZ App – erhältlich im App Store oder bei Google Play.

Easy and quick to install. Full functionality and flexibility with the WiZ App – available on the App Store or on Google Play.



WiZ MOTE

Steuerung über die Fernbedienung und Abspeichern von vier favorisierten Lichtmodi möglich.

Control via the remote control and possibility to save four favorite light modes.

DIMMEN DIMMING



64.000 **WEISSTÖNE**
64,000 **WHITES**

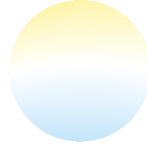

Einstellbare Lichtprogramme · Preset light modes



16 Millionen **FARBEN**
16 million **COLORS**



Dynamische Lichtprogramme · Dynamic light modes



30 Sekunden zur Installation · **30** seconds to install



Die Lampe installieren
Install a lamp



Wählen Sie den „Koppeln“ Modus
Start pairing



3 x EIN / AUS
3 x ON/OFF



Die Lampe beginnt „blau“ zu blinken und
schaltet danach auf weiß
Light turns blue then goes white



Die Einstellungen sind nun gespeichert,
jeder kann zu Hause WiZ nutzen.
The settings are now saved!
Now everyone can use WiZ at your home.

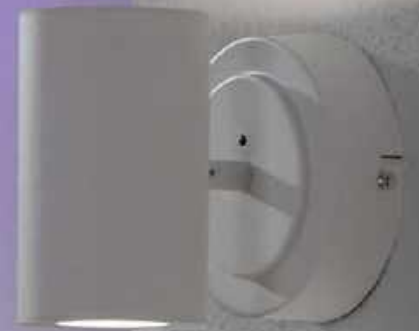

„Alexa, schalte das Licht im Wohnzimmer ein.“

‘Alexa, turn on the light in the living room!’



„OK Google, mach die Lichter grün.“

‘OK Google, turn the lights green!’





42

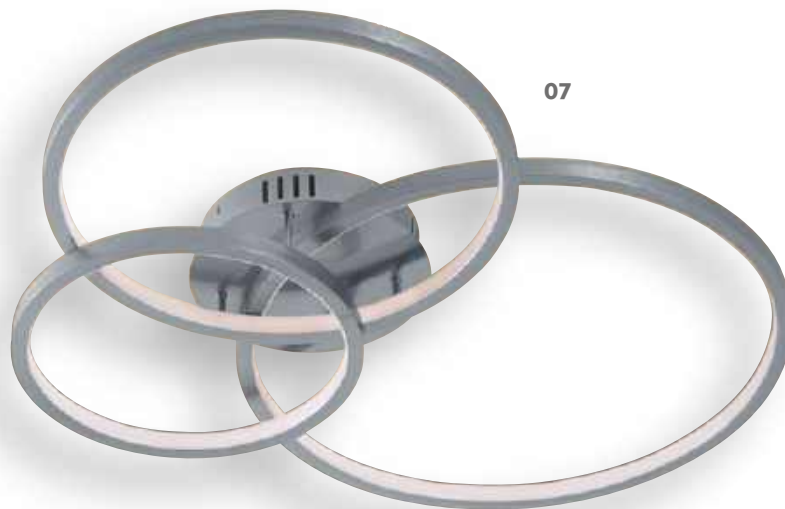

07

AARON

Metall, Nickel matt oder Anthrazit · metal, nikel mat or anthracite ·
metale, nikel mat ou antracite · metaal, nikel mat of antraciet ·
metal, níquel mate o antracita · metallo, nichel opaco o antracite ·
metal, nichel mat sau antracit · metalli, harjattu teräs tai antrasiitti ·
metal, nikiel mat lub antracyt



44



↔ 79 x 64 cm, ↑ 10,5 cm
incl. RGBW-LED, 36 W
3.000 lm, 3.000 - 6.000 K



652710307
652710342



∅ 80 cm, ↑ 150 cm
incl. RGBW-LED, 80 W
7.000 lm, 3.000 - 6.000 K



352710307
352710342



07 Nickel matt · nikel mat
42 Anthrazit · anthracite

+





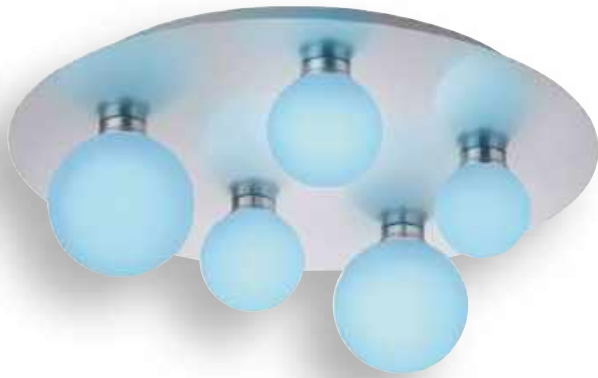

DICAPO

Nickel matt, Glas matt · nickel mat, mat glass ·
nickel mat, verre mat · nikkel mat, mat glas · níquel mate, vidrio mate ·
nichel opaco, vetro sabbiato · nichel mat, sticla mata ·
harjattu teräs, mattalasi · nikiel mat, szkło matowane



Ø 50 cm, ↑ 16,5 cm
incl. 5 x RGBW-LED, 3 W
5 x 300 lm, 3.000 - 5.000 K



650810507



↔ 95 x 12 cm, ↑ 150 cm
incl. 5 x RGBW-LED, 3 W
5 x 300 lm, 3.000 - 5.000 K



350810507



↑ 54 cm, ↔ 16 cm
incl. 2 x RGBW-LED, 3 W
2 x 300 lm, 3.000 - 5.000 K



550810207



↑ 153 cm, ↔ 21,5 cm
incl. 4 x RGBW-LED, 3 W
4 x 300 lm, 3.000 - 5.000 K



450810407



Ø 52,5 x 54 cm, ↑ 150 cm
incl. 6 x RGBW-LED, 3 W
6 x 300 lm, 3.000 - 5.000 K



350810607

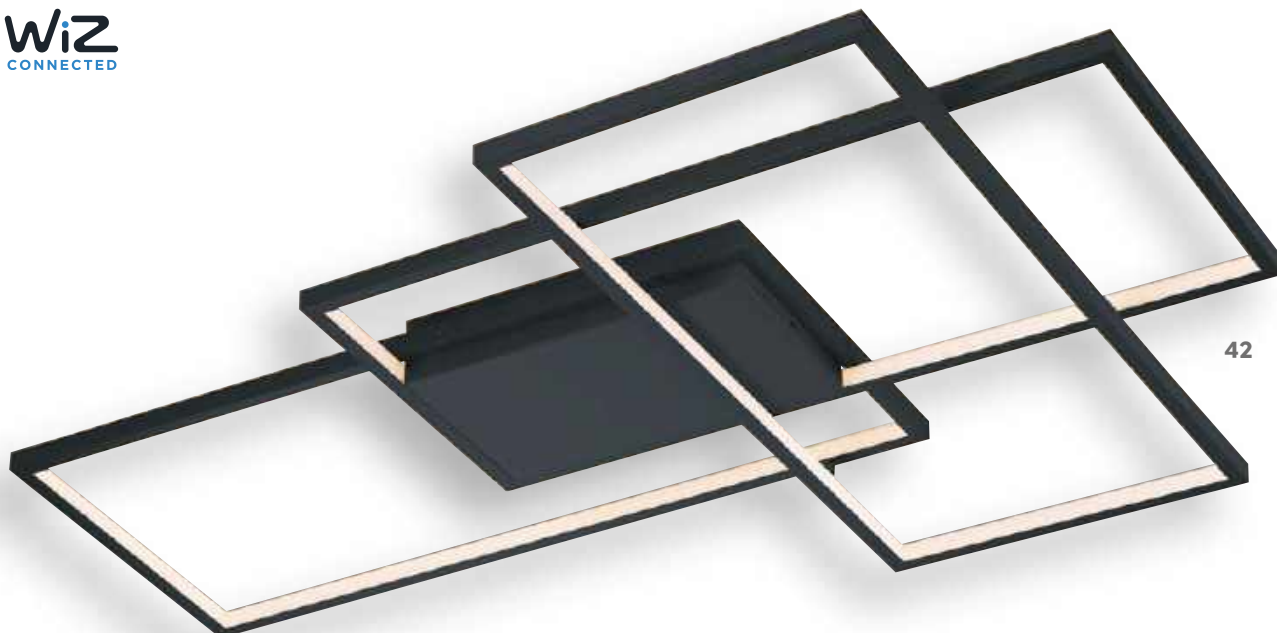

42

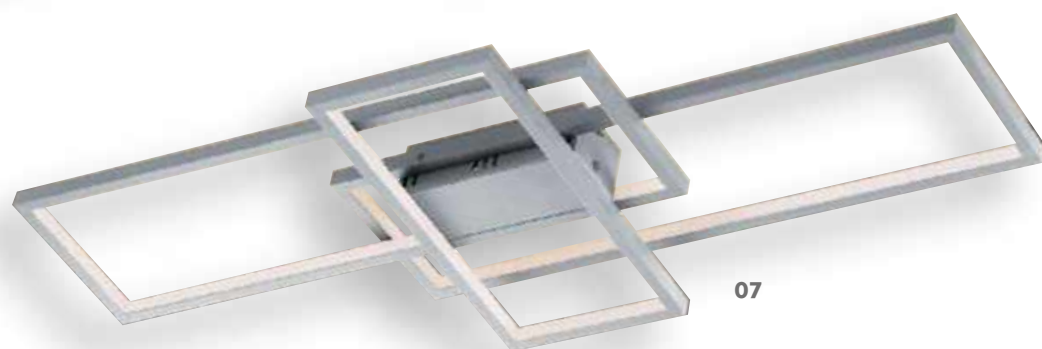

07

THIAGO

Metall, Nickel matt oder Anthrazit · metal, nickel mat or anthracite ·
metale, nickel mat ou antracite · metaal, nikkel mat of antraciet ·
metal, níquel mate o antracita · metallo, nichel opaco o antracite ·
metal, nichel mat sau antracit · metalli, harjattu teräs tai antrasiitti ·
metal, nikiel mat lub antracyt



↔ 104 x 42 cm, ↓ 8,5 cm
incl. RGBW-LED, 36 W
3.000 lm, 3.000 - 6.000 K



652610307
652610342

↔ 114 x 75 cm, ↓ 7,5 cm
incl. RGBW-LED, 40 W
3.400 lm, 3.000 - 6.000 K



652690307
652690342



07 Nickel matt · nickel mat
42 Anthrazit · anthracite







CITIZEN

Metall, Nickel matt oder Schwarz matt · metal, nickel mat or black mat ·
 metale, nickel mat ou noir mat · metaal, nikkel mat of mat zwart · metal, níquel mate o estera negra ·
 metallo, nichel opaco o nero opaco · metal, nichel mat sau negru mat · metalli, harjattu teräs tai mattamusta ·
 metal, nikiel mat lub czarny mat



↔ 95 x 55 cm, ↑ 8 cm
 incl. 2 x RGBW-LED, 17 W
 max. 2 x 1.700 lm, 3.000 - 5.000 K



651110207
 651110232



07 Nickel matt · nickel mat
 32 Schwarz matt · black mat







OSCAR

Metall, Weiß matt oder Schwarz matt, Acryl · metal, white mat or black mat, acryl ·
 metale, blanc mat ou noir mat, acryl · metaal, wit mat of mat zwart, acryl ·
 metal, estera blanca o estera negra, acrílico · metallo, bianco opaco o nero opaco, acrilico ·
 metal, alb mat sau negru mat, acrilic · metalli, mattavalkoinen tai mattamusta, akryyli ·
 metal, biały mat lub czarny mat, akryl



↔ 30 x 30 cm, ↑ 32,5 cm
 incl. 3 x RGBW-LED, 8 W
 3 x 700 lm, 3.000 - 6.000 K



652810331
 652810332

↔ 45 x 30 cm, ↑ 32,5 cm
 incl. 5 x RGBW-LED, 7 W
 5 x 600 lm, 3.000 - 6.000 K



652810531
 652810532



31 Weiß matt · white mat
 32 Schwarz matt · black mat

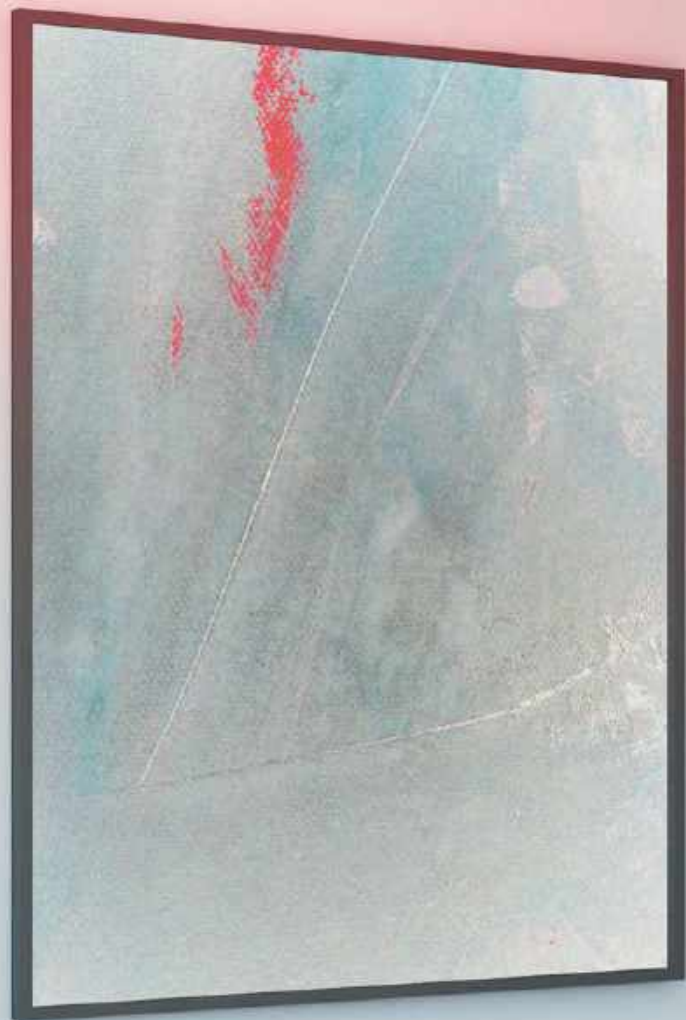
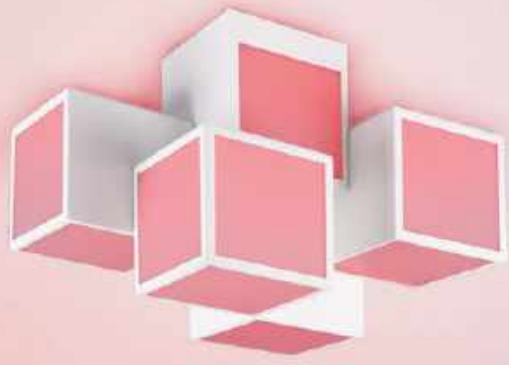



GRIFFIN

Nickel matt, Acryl · nickel mat, acryl ·
nickel mat, acryl · nikkell mat, acryl · níquel mate, acrílico · nichel opaco, acrilico ·
nichel mat, acrilicharjattu teräs, akryyli · nikiel mat, akryl



Ø 30 cm, ↓ 5 cm
incl. SMD-LED, 15 W
1.500 lm, 3.000 - 5.500 K



657493007



Ø 40 cm, ↓ 5 cm
incl. SMD-LED, 20 W
2.000 lm, 3.000 - 5.500 K



657494007



Ø 60 cm, ↓ 5 cm
incl. SMD-LED, 36 W
3.600 lm, 3.000 - 5.500 K



657496007



↔ 30 x 30 cm, ↓ 5 cm
incl. SMD-LED, 15 W
1.500 lm, 3.000 - 5.500 K



657413007



↔ 40 x 40 cm, ↓ 5 cm
incl. SMD-LED, 20 W
2.000 lm, 3.000 - 5.500 K



657414007

↔ 60 x 60 cm, ↓ 5 cm
incl. SMD-LED, 36 W
3.600 lm, 3.000 - 5.500 K



657416007

↔ 110 x 30 cm, ↓ 5 cm
incl. SMD-LED, 36 W
3.600 lm, 3.000 - 5.500 K



657411107



Starlight effect

NALIDA

Acryl, weiß · acryl, white ·
acryl, blanc · acryl, wit · acrílico, blanco · acrilico, bianco ·
acrilic, alb · akryyli, valkoinen · akryl, biały



Ø 74 cm, ↓ 10 cm
incl. RGBW-LED, 40 W
max. 3.700 lm, 3.000 - 5.500 K



656090101



Starlight effect
Ø 74 cm, ↓ 10 cm
incl. RGBW-LED, 40 W
max. 3.700 lm, 3.000 - 5.500 K



656090100

MELBY

Nickel matt, Acryl · nickel mat, acryl ·
nickel mat, acryl · nikkell mat, acryl · níquel mate, acrílico ·
nichel opaco, acrílico · nichel mat, acrílico · harjattu teräs, akryyli ·
nikiel mat, akryl



Direkte und indirekte Beleuchtung · up and down lighting ·
point lumineux en haut et en bas · lichtpunt boven en onder ·
luz de arriba y abajo · luce su e giù · sus și în jos lumina ·
ylös ja alas valoa · w górę iw dół światło



↔ max. 242 cm, ↑ 12 cm
incl. RGBW-LED, 23 W
max. 2.200 lm, 3.000 - 5.000 K



651210507



Starlight effect

IMARA

Acryl, weiß · acryl, white ·
acryl, blanc · acryl, wit · acrílico, blanco · acrilico, bianco ·
acrilic, alb · akryyli, valkoinen · akryl, biały



Starlight effect

CHARLY

Acryl, weiß · acryl, white ·
acryl, blanc · acryl, wit · acrílico, blanco · acrilico, bianco ·
acrilic, alb · akryyli, valkoinen · akryl, biały



↔ 110 x 30 cm, ↑ 7,7 cm
incl. RGBW-LED, 40 W
max. 3.700 lm, 3.000 - 5.500 K



658810101

Starlight effect
↔ 110 x 30 cm, ↑ 7,7 cm
incl. RGBW-LED, 40 W
max. 3.700 lm, 3.000 - 5.500 K



658810100

Ø 50 cm, ↑ 12 cm
incl. RGBW-LED, 27 W
max. 2.550 lm, 3.000 - 5.500 K



656010101

Starlight effect
Ø 50 cm, ↑ 12 cm
incl. RGBW-LED, 27 W
max. 2.550 lm, 3.000 - 5.500 K



656010100



PANTILON

Acryl, weiß · acryl, white ·
acryl, blanc · acryl, wit · acrílico, blanco ·
acrilico, bianco · acrilic, alb · akryyli, valkoinen ·
akryl, biały



↑ 150 cm, Ø 24 cm
incl. SMD-LED, 22 W
2.200 lm, 3.000 - 6.000 K



451850101

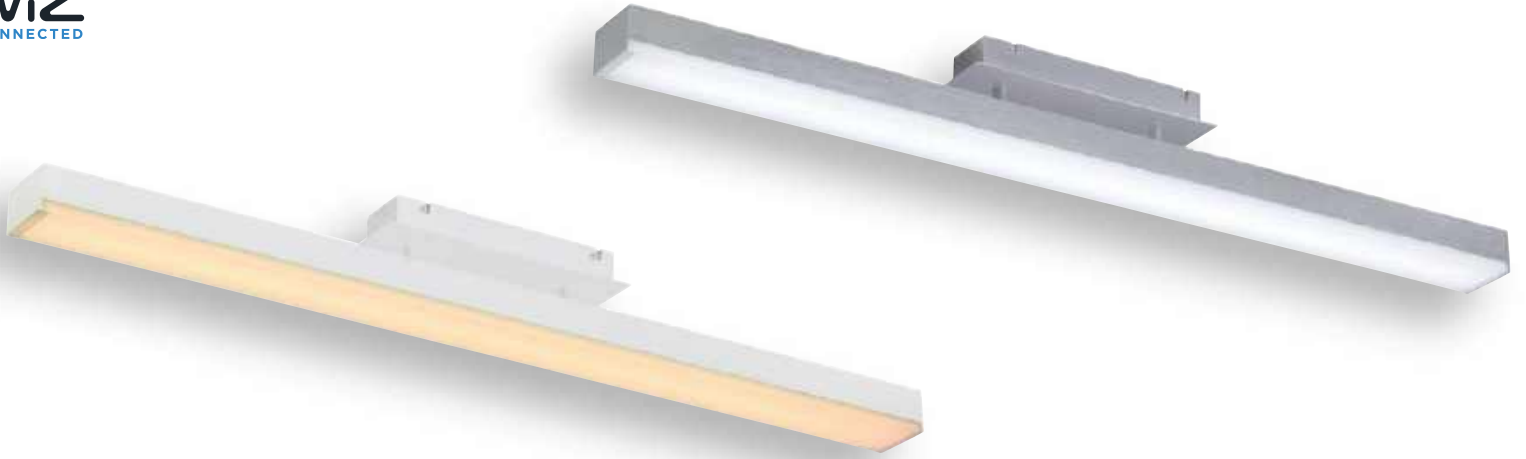

LIVARO

Nickel matt oder Weiß matt · nickel mat or white mat ·
nickel mat ou blanc mat · nikkel mat of wit mat ·
níquel mate o estera blanca · nichel opaco o bianco opaco ·
nichel mat sau alb mat · harjattu teräs tai valkoinen matto ·
nikiel mat lub biały mat

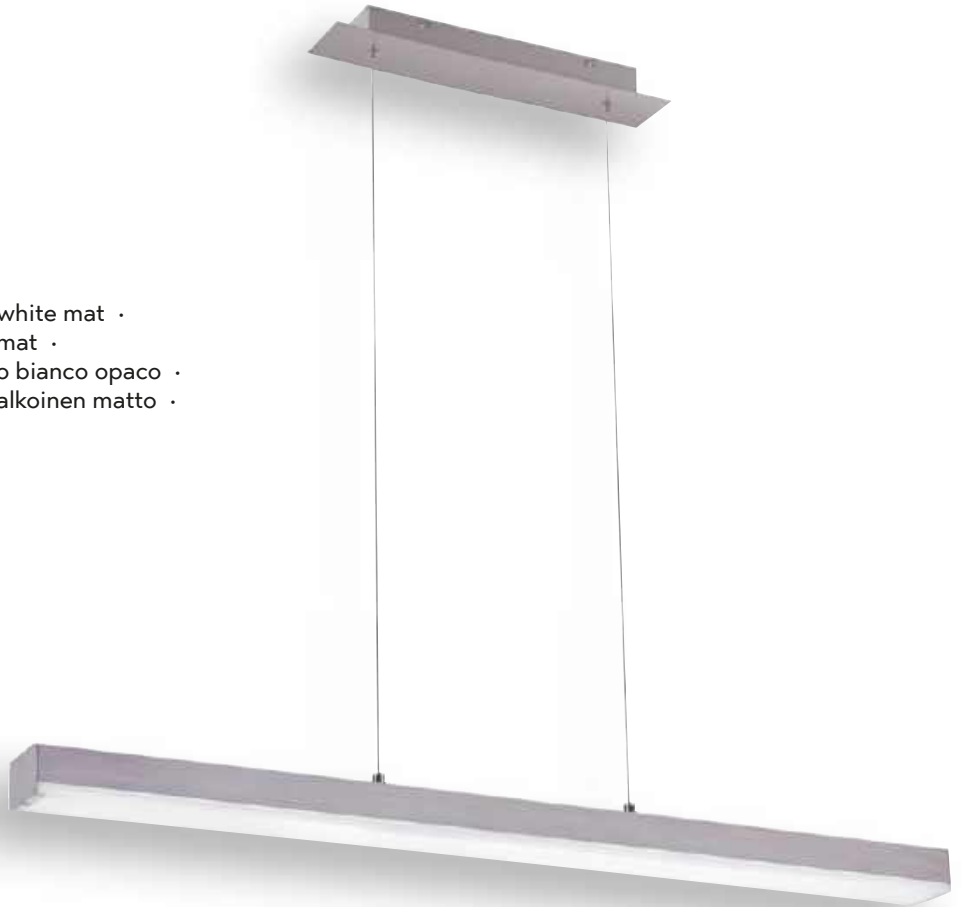

↔ 100 x 8 cm, ↑ 12 cm
incl. RGBW-LED, 20 W
max. 2.000 lm, 3.000 - 5.000 K



658210107
658210131

↔ 100 x 8 cm, ↑ 150 cm
incl. RGBW-LED, 20 W
max. 2.000 lm, 3.000 - 5.000 K



358210107
358210131



07 Nickel matt · nickel mat
31 Weiß matt · white mat





DIAMO

Stoff weiß · fabric white ·
tissu blanc · textiel wit · tela blanco · tessuto bianco ·
textil alb · tekstiili valkoinen · tkanina biały



62



Ø 60 cm, ↑ 10 cm
incl. RGBW-LED, 36 W
max. 3.400 lm, 3.000 - 5.000 K



651914001

Ø 75 cm, ↑ 10 cm
incl. 1 x RGBW-LED, 45 W
max. 4.200 lm, 3.000 - 5.000 K



651915501





ADRIANA

Metall, Nickel matt, Weiß matt oder Schwarz matt · metal, nickel mat, white mat or black mat ·
 metale, nickel mat, blanc mat ou noir mat · metaal, nikkel mat, wit mat of mat zwart ·
 metal, níquel mate, estera blanca o estera negra · metallo, nichel opaco, bianco opaco o nero opaco ·
 metal, nichel mat, alb mat sau negru mat · metalli, harjattu teräs, mattavalkoinen tai mattamusta ·
 metal, nikiel mat, biały mat lub czarny mat



↔ 30 x 6 cm, ʘ 9 cm
 incl. RGBW-LED, 5,5 W
 450 lm, 3.000 - 6.500 K



250810207
 250810231
 250810232

07 Nickel matt · nickel mat
 31 Weiß matt · white mat
 32 Schwarz matt · black matt



31

FIGO

Metall, Aluminium gebürstet, Weiß matt oder Schwarz matt · metal, brushed aluminium, white mat or black mat · metale, aluminium balayé, blanc mat ou noir mat · metaal, geborsteld aluminium, wit mat of mat zwart · metal, aluminio pulido, estera blanca o estera negra · metallo, alluminio spazzolato, bianco opaco o nero opaco · metal, aluminiu lucios, alb mat sau negru mat · metalli, harjattu alumiini, mattavalkoinen tai mattamusta · metal, aluminium szczotkowane, biały mat lub czarny mat



05



32



↔ 10 x 10 cm, √ 10 cm
incl. RGBW-LED, 5,5 W
450 lm, 3.000 - 6.500 K



253310105
253310131
253310132

05 Aluminium gebürstet · brushed aluminium
31 Weiß matt · white mat
32 Schwarz matt · black matt



VISTA

Nickel matt oder Weiß matt · nickel mat or white mat ·
nickel mat ou blanc mat · nikkell mat of wit mat ·
níquel mate o estera blanca · nichel opaco o bianco opaco ·
nichel mat sau alb mat · harjattu teräs tai valkoinen matto ·
nikiel mat lub biały mat

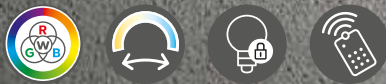

Ø 11 cm, 17,5 cm
incl. 2 x RGBW-LED, 3,8 W
2 x 380 lm, 3.000 - 5.000 K



255410207
255410231

07 Nickel matt · nickel mat
31 Weiß matt · white mat

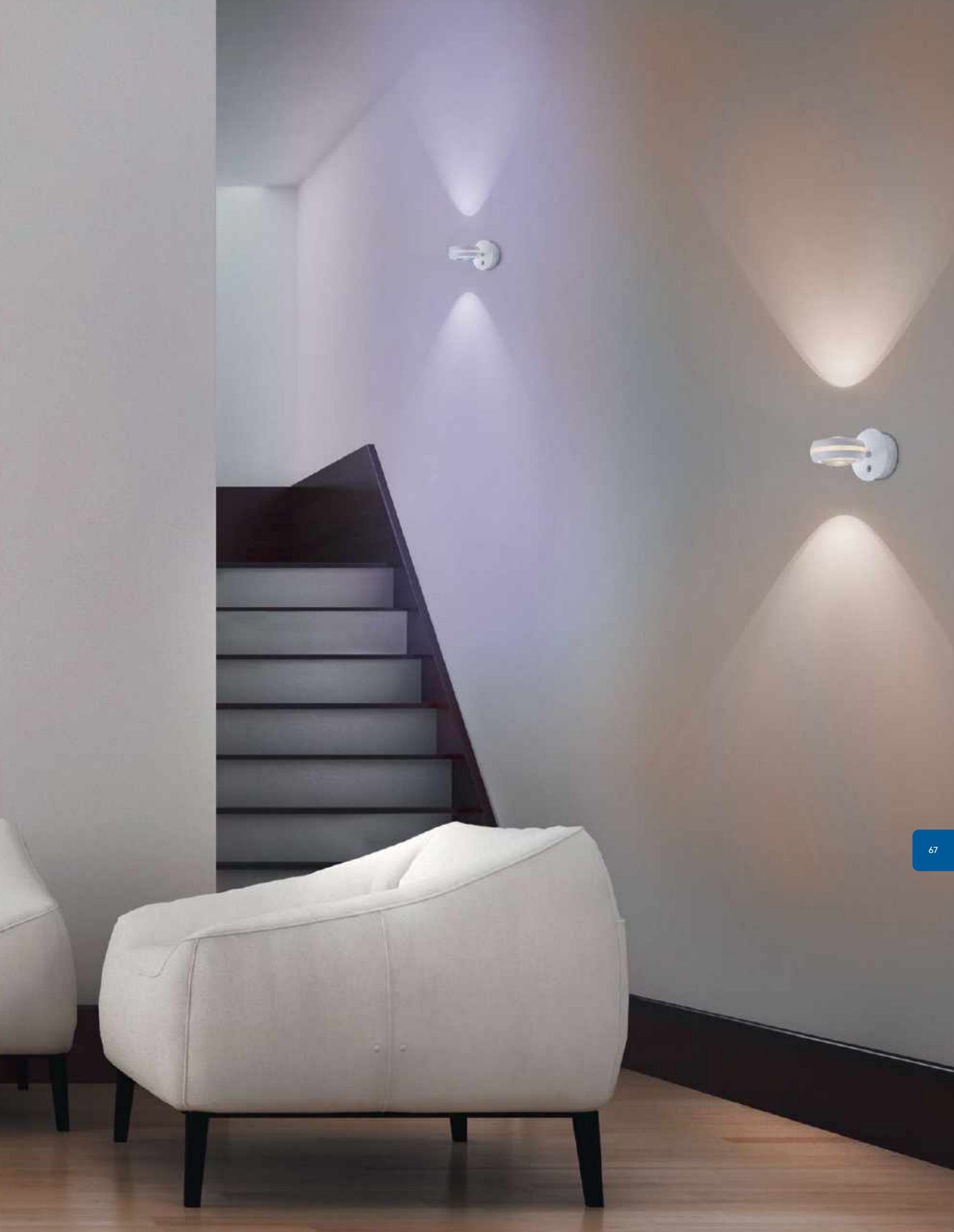



SANCHO

Metall, Weiß matt oder Schwarz matt · metal, white mat or black mat ·
metale, blanc mat ou noir mat · metaal, wit mat of mat zwart ·
metal, estera blanca o estera negra · metallo, bianco opaco o nero opaco ·
metal, alb mat sau negru mat · metalli, valkoinen matto tai musta matto ·
metal, biały mat lub czarny mat



↑ 13 cm, ↔ 12 cm, √ 15 cm
incl. 2 x RGBW-LED, 3 W
2 x 300 lm, 3.000 - 5.000 K



250110231
250110232

↔ 32 x 11 cm, ↑ 12,5 cm
incl. 2 x RGBW-LED, 3 W
2 x 300 lm, 3.000 - 5.000 K



850110231
850110232

↔ 55 x 11 cm, ↑ 12,5 cm
incl. 4 x RGBW-LED, 3 W
4 x 300 lm, 3.000 - 5.000 K



850110431
850110432

Ø 25 cm, ↑ 12,5 cm
incl. 3 x RGBW-LED, 3 W
3 x 300 lm, 3.000 - 5.000 K



850190331
850190332



- 01 Weiß matt · white mat
- 02 Schwarz matt · black mat



DAMIAN

Nickel matt, Glas weiß matt · nickel mat, glass white mat ·
 nickel mat, verre blanc mat · nikkell mat, glas wit mat ·
 níquel mate, vidrio estera blanca · nichel opaco, vetro bianco opaco ·
 nichel mat, sticla alb mat · harjattu teräs, lasi mattavalkoinen ·
 nikiel mat, szkło biały mat



Ø 30 cm, ↑ 29 cm
 incl. 1 x RGBW-LED E27, 11,5 W
 max. 806 lm, 2.200 - 6.500 K



551610107



Ø 30 cm, ↑ 150 cm
 incl. 1 x RGBW-LED E27, 11,5 W
 max. 806 lm, 2.200 - 6.500 K



351610107



Ø 45 cm, ↑ 150 cm
 incl. 1 x RGBW-LED E27, 11,5 W
 max. 806 lm, 2.200 - 6.500 K



351690107





TRISTAN

Metall weiß, Glas weiß matt · metal white, glass white mat ·
 metale blanc, verre blanc mat · metaal wit, glas wit mat ·
 metal blanco, vidrio estera blanca · metallo bianco, vetro bianco opaco ·
 metal alb, sticla alb mat · metalli valkoinen, lasi mattavalkoinen · metal biały, szkło biały mat



↔ 13 cm, ↑ 44 cm, ↗ 13 cm
 incl. 1 x RGBW-LED E27, 11,5 W
 max. 806 lm, 2.200 - 6.500 K



254700101



↓ 150 cm, Ø 23 cm
 incl. 1 x RGBW-LED E27, 11,5 W
 max. 806 lm, 2.200 - 6.500 K



354790101





64.000
WEISSTÖNE
64,000 WHITES



16 Millionen
FARBEN
16 million COLORS



wizconnected.com



↓ 109 mm, ↔ 56 mm
RGBW-LED E14, 7,5 W
max. 470 lm, 2.200 - 6.500 K
25.000 h



983-88



↓ 118 mm, ↔ 66 mm
RGBW-LED E27, 11,5 W
max. 806 lm, 2.200 - 6.500 K
25.000 h



987-88



↓ 73 mm, ↔ 50 mm
RGBW-LED GU10, 6,5 W
max. 360 lm, 2.200 - 6.500 K
25.000 h



956-88



NECTOR

Kunststoff, weiß · plastic, white ·
 plastique, blanc · kunststof, wit · plástico, blanco ·
 plastica, bianco · plastic, alb · muovi, valkoinen · plastik, biały



IP44



Ø 30 cm, ↑ 25,5 cm
 incl. RGBW-LED, 8,5 W
 600 lm, 3.000 - 5.500 K



551753001



Ø 40 cm, ↑ 37 cm
 incl. RGBW-LED, 8,5 W
 600 lm, 3.000 - 5.500 K



551754001









Leuchtenfamilien & Kombinationen

Families & coordinates

Familles & coordonnés

Families & combinaties

Familias & coordinados

Famiglie & coordinati

Famillii & Coordonate

Tuoteperheet & yhdistettävät tuotteet

Rodzinne orawy & kombinacje

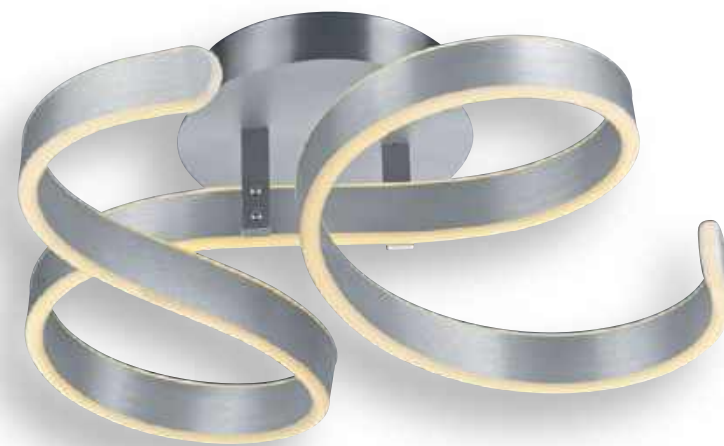

FRANCIS

Metall, Aluminium gebürstet, Weiß matt oder Anthrazit · metal, brushed aluminium, white mat or anthracite ·
 metale, aluminium balayé, blanc mat ou antracite · metaal, geborsteld aluminium, wit mat of antraciet ·
 metal, aluminio pulido, estera blanca o antracita · metallo, alluminio spazzolato, bianco opaco o antracite ·
 metal, aluminiu lucios, alb mat sau antracit · metalli, harjattu alumiini, mattavalkoinen tai antrasiitti ·
 metal, aluminium szczotkowane, biały mat lub antracyt

LED SWITCHDIMMER



↔ 54 x 52 cm, ↑ 19,5 cm
 incl. SMD-LED, 40 W
 6.000 lm, 3.000 K



671310105
 671310131
 671310142



↔ 72 x 68 cm, ↑ 150 cm
 incl. SMD-LED, 52 W
 6.500 lm, 3.000 K



371310105
 371310131
 371310142



05 Aluminium gebürstet · brushed aluminium
31 Weiß matt · white mat
42 Anthrazit · anthracite





OAKLAND

Metall, Nickel matt oder Anthrazit · metal, nickel mat or anthracite ·
 metale, nickel mat ou antracite · metaal, nikkel mat of antraciet ·
 metal, níquel mate o antracita · metallo, nichel opaco o antracite ·
 metal, nichel mat sau antracit · metalli, harjattu teräs tai antrasiitti ·
 metal, nikiel mat lub antracyt

LED SWITCHDIMMER



Ø 53 cm, ↑ 23,5 cm
 incl. SMD-LED, 40 W
 4.400 lm, 3.000 K



621710107
 621710142



Ø 71 cm, ↑ 150 cm
 incl. SMD-LED, 52 W
 5.650 lm, 3.000 K



321710107
 321710142



↓ 180 cm, Ø 47 cm
 incl. SMD-LED, 25 W
 2.750 lm, 3.000 K



421710107
 421710142



07 Nickel matt · nickel mat
 42 Anthrazit · anthracite







CARRERA

Metall, Aluminium gebürstet oder Schwarz matt · metal, brushed aluminium or black mat ·
 metale, aluminium balayé ou noir mat · metaal, geborsteld aluminium of mat zwart ·
 metal, aluminio pulido o estera negra · metallo, alluminio spazzolato o nero opaco ·
 metal, aluminiu lucios sau negru mat · metalli, harjattu alumiini tai mattamusta ·
 metal, aluminium szczotkowane lub czarny mat

LED SWITCHDIMMER



Ø 45 cm, ↑ 22 cm
 incl. SMD-LED, 38 W
 4.400 lm, 3.000 K



625010105
 625010132



↑ 150 cm, Ø 55 cm
 incl. SMD-LED, 38 W
 4.400 lm, 3.000 K



325010105
 325010132



05 Aluminium gebürstet · brushed aluminium
 32 Schwarz matt · black mat





LOGAN

Metall, Nickel matt, Weiß matt oder Anthrazit · metal, nickel mat, white mat or anthracite ·
 metals, nickel mat, white mat or anthracite · metaal, nikkell mat, wit mat of antraciet ·
 metal, níquel mate, estera blanca o antracita · metallo, nichel opaco, bianco opaco o antracite ·
 metal, nichel mat, alb mat sau antracit · metalli, harjattu teräs, mattavalkoinen tai antrasiitti ·
 metal, nikiel mat, biały mat lub antracyt

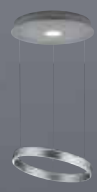
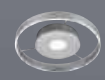
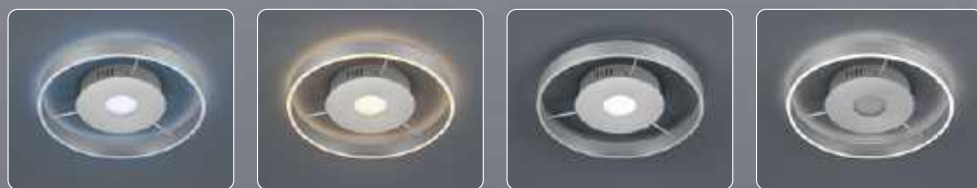

Ø 50 cm, ↑ 8 cm
 incl. SMD-LED, 45 W
 4.000 lm, 2.700 - 6.000 K



625710207
 625710231
 625710242

Ø 54 cm, ↑ 150 cm
 incl. SMD-LED, 45 W
 4.000 lm, 3.000 K (31 = 4.000 K)



325710207
 325710231
 325710242



07 Nickel matt · nickel mat
 31 Weiß matt · white mat
 42 Anthrazit · anthracite

LIFT ME



Innovative Höhenverstellung ohne Gegengewicht · Innovative height adjustment without counterweight · Nouveau! Réglage de la hauteur sans contrepoids · Innovatieve hoogteverstelling zonder contragewicht · Innovador sistema de ajuste de altura sin necesidad de contrapeso · Regolazione innovativa dell'altezza senza contrappeso · Ajustare inovativa a inaltimii fara contragreutate · Innovatiivinen korkeuden säätö ilman vastapainoa · Innowacyjna regulacja wysokości bez przeciwwagi

4.000 Kelvin



LED SWITCHDIMMER



COMPTON

Metall, Nickel matt oder Anthrazit · metal, nickel mat or anthracite ·
metale, nickel mat ou antracite · metaal, nikkell mat of antraciet ·
metal, níquel mate o antracita · metallo, nichel opaco o antracite ·
metal, nichel mat sau antracit · metalli, harjattu teräs tai antrasiitti ·
metal, nikiel mat lub antracyt



↑ 39 cm, Ø 36 cm
incl. SMD-LED, 19 W
2.100 lm, 3.000 K



521810207
521810242



Ø 50 cm, ↑ 150 cm
incl. SMD-LED, 45 W
5.000 lm, 3.000 K



321810307
321810342



07 Nickel matt · nickel mat
42 Anthrazit · anthracite



LINCOLN

Metall, Weiß matt · metal, white mat ·
 metale, blanc mat · metaal, wit mat · metal, estera blanca · metallo, bianco opaco ·
 metal, alb mat · metalli, mattavalkoinen · metal, biały mat

LED SWITCH DIMMER



↔ 49 x 30 cm, ↑ 10 cm
 incl. SMD-LED, 30 W
 2.400 lm, 3.000 K



670410231



∅ 50 cm, ↑ 12,8 cm
 incl. SMD-LED, 45 W
 3.600 lm, 3.000 K



670410331



↔ 85 x 48 cm, ↑ 150 cm
 incl. SMD-LED, 60 W
 4.800 lm, 3.000 K



370410231

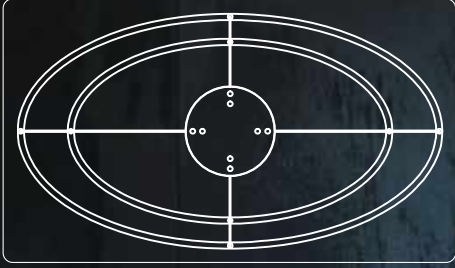

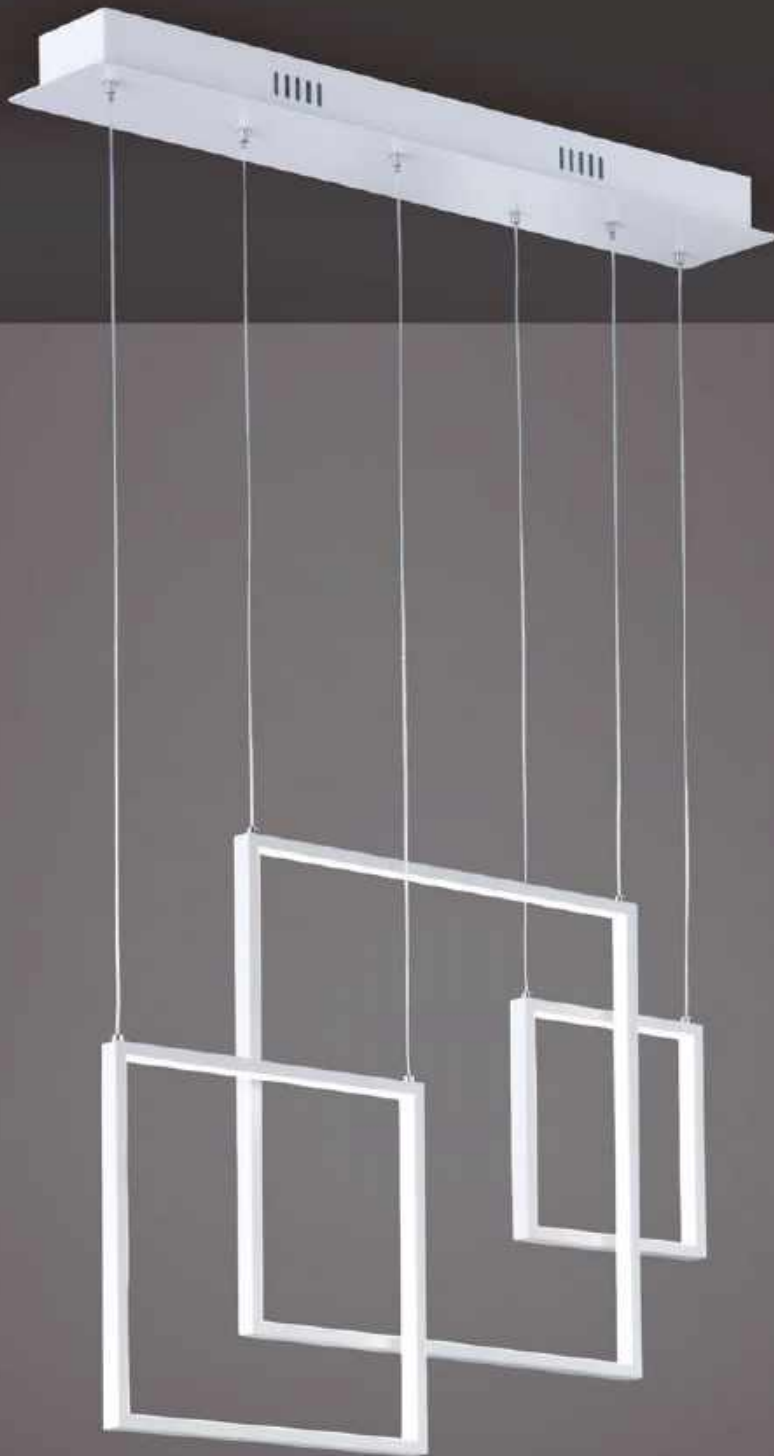

TUCSON

Metall, Weiß matt · metal, white mat ·
 metale, blanc mat · metaal, wit mat · metal, estera blanca ·
 metallo, bianco opaco · metal, alb mat · metalli, valkoinen matto ·
 metal, biały mat

LED SWITCHDIMMER



↔ 104 x 42 cm, ↑ 8,5 cm
 incl. SMD-LED, 35 W
 3.300 lm, 3.000 K



672610331

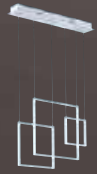

↔ 70 x 19 cm, ↑ 150 cm
 incl. SMD-LED, 26 W
 2.200 lm, 3.000 K



372610331

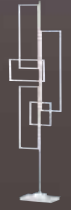

↑ 160 x 18 cm, ↔ 44 cm
 incl. SMD-LED, 44 W
 3.750 lm, 3.000 K



472610531





CAFU

Metall, Anthrazit / Weiß, Acryl · metal, anthracite / white, acryl ·
 metale, antracite / blanc, acryl · metaal, antraciet / wit, acryl ·
 metal, antracita / blanco, acrílico · metallo, antracite / bianco, acrilico ·
 metal, antracit / alb, acrylic · metalli, antrasiitti / valkoinen, akryyli ·
 metal, antracyt / biały, akryl

LED SWITCHDIMMER

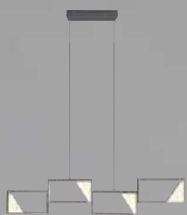

↔ 106 x 8,5 cm, ↑ 150 cm
 incl. SMD-LED, 28 W
 2.800 lm, 3.000 K



323210442



↑ 46 cm, ↔ 27,4 x 10 cm
 incl. SMD-LED, 14 W
 1.400 lm, 3.000 K



523210242



↑ 130,5 cm, ↔ 28 x 12 cm
 incl. SMD-LED, 33 W
 3.300 lm, 3.000 K



423210542



↔ 53,4 x 28 cm, ↑ 5,2 cm
 incl. SMD-LED, 14 W
 1.400 lm, 3.000 K



623210242

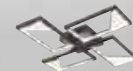

↔ 54,4 x 54,4 cm, ↑ 5,2 cm
 incl. SMD-LED, 28 W
 2.800 lm, 3.000 K



623210442



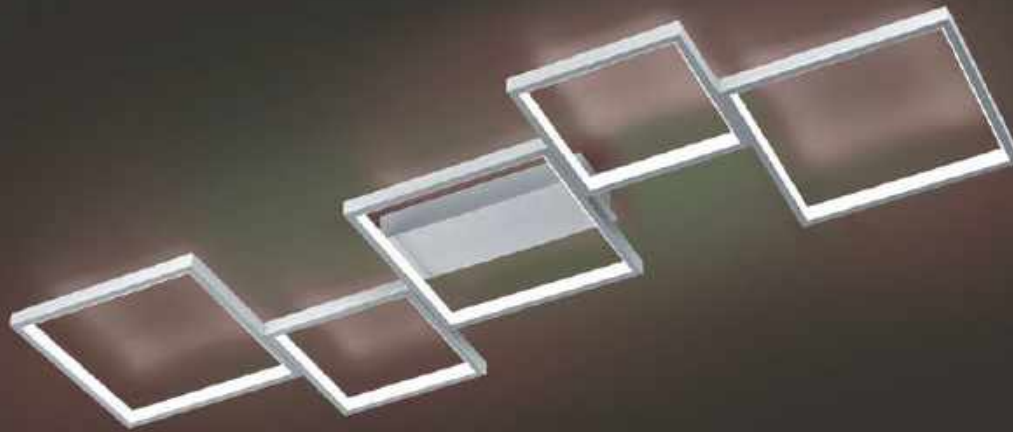

SORRENTO

Metall, Aluminium gebürstet oder Schwarz matt · metal, brushed aluminium or black mat ·
 metale, aluminium balayé ou noir mat · metaal, geborsteld aluminium of mat zwart ·
 metal, aluminio pulido o estera negra · metallo, alluminio spazzolato o nero opaco ·
 metal, aluminiu lucios sau negru mat · metalli, harjattu alumiini tai mattamusta ·
 metal, aluminium szczotkowane lub czarny mat

LED SWITCHDIMMER



↔ 52 x 52 cm, ↑ 16 cm
 incl. SMD-LED, 24 W
 2.400 lm, 3.000 K



627710405
 627710432

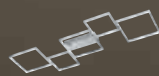

↔ 120 x 48 cm, ↑ 6 cm
 incl. SMD-LED, 34 W
 3.400 lm, 3.000 K



627710505
 627710532



↑ 50 cm, ↔ 24 cm
 incl. SMD-LED, 15 W
 1.500 lm, 3.000 K



527710305
 527710332



↑ 125 cm, ↔ 48 cm
 incl. SMD-LED, 34 W
 3.400 lm, 3.000 K



427710505
 427710532



05 Aluminium gebürstet · brushed aluminium
32 Schwarz matt · black mat





Getrennt schaltbar · Separately switchable
 Interrupteurs séparés · Gescheiden schakelbaar ·
 Interruptores separados · Interruttori separati ·
 Intreruptoare separate · Erikseen kytkettävissä ·
 Oddzileny przełącznik



BELFAST

Metall, Nickel matt oder Schwarz matt · metal, nickel mat or black mat ·
 metale, nickel mat ou noir mat · metaal, nikkell mat of mat zwart ·
 metal, níquel mate o estera negra · metallo, nichel opaco o nero opaco ·
 metal, nichel mat sau negru mat · metalli, harjattu teräs tai mattamusta ·
 metal, nikiel mat lub czarny mat



LED SWITCHDIMMER



↔ 60 x 30 cm, ↗ 7
 incl. 2 x SMD-LED, 10,5 W
 2 x 1.050 lm, 3.000 K



↔ 59 x 59 cm, ↑ 6,5 cm
 incl. SMD-LED, 18 W
 1.700 lm, 3.000 K
 incl. 4 x SMD-LED, 3,5 W
 4 x 350 lm, 3.000 K



↔ 115 x 18 cm, ↓ 150 cm
 incl. SMD-LED, 44 W
 4.400 lm, 3.000 K



275510207
 275510232



675510507
 675510532



375510407
 375510432



07 Nickel matt · nickel mat
 32 Schwarz matt · black mat

LED SWITCHDIMMER



LED SWITCHDIMMER



BELFAST

Metall, Weiß matt · metal, white mat ·
metale, blanc mat · metaal, wit mat · metal, estera blanca ·
metallo, bianco opaco · metal, alb mat · metalli, mattavalkoinen · metal, biały mat



4.000 Kelvin



↔ 60 x 30 cm, ↗ 7
incl. 2 x SMD-LED, 10,5 W
2 x 1.100 lm, 4.000 K



275510231

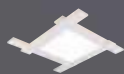

↔ 59 x 59 cm, ↓ 6,5 cm
incl. SMD-LED, 18 W
1.800 lm, 4.000 K
incl. 4 x SMD-LED, 3,5 W
4 x 380 lm, 4.000 K



675510531



↔ 115 x 18 cm, ↓ 150 cm
incl. SMD-LED, 44 W
4.600 lm, 4.000 K



375510431



Getrennt schaltbar ·
Separately switchable ·
Interrupteurs séparés ·
Gescheiden schakelbaar ·
Interruptores separados ·
Interruttori separati ·
Interrupatoare separate ·
Erikseen kytkettävissä ·
Oddzieleny przełącznik



LED SWITCHDIMMER



4.000 Kelvin



4.000 Kelvin

SALERNO

Metall, Weiß matt oder Schwarz matt · metal, white mat or black mat ·
 metale, blanc mat ou noir mat · metaal, wit mat of mat zwart ·
 metal, estera blanca o estera negra · metallo, bianco opaco o nero opaco ·
 metal, alb mat sau negru mat · metalli, mattavalkoinen tai mattamusta ·
 metal, biały mat lub czarny mat

LED SWITCHDIMMER

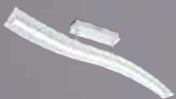

↔ 90 x 12 cm, ↑ 27,5 cm
 incl. SMD-LED, 24 W
 2.900 lm, 4.000 K
(32 = 2.400 lm, 3.000 K)



624610131
 624610132



↔ 115 x 12 cm, ↑ 150 cm
 incl. SMD-LED, 35 W
 4.100 lm, 4.000 K
(32 = 3.500 lm, 3.000 K)



324610131
 324610132



↑ 140 cm, ↔ 22 x 22 cm
 incl. SMD-LED, 31 W
 3.700 lm, 4.000 K
(32 = 2.900 lm, 3.000 K)



424610131
 424610132



31 Weiß matt · white mat
32 Schwarz matt · black mat



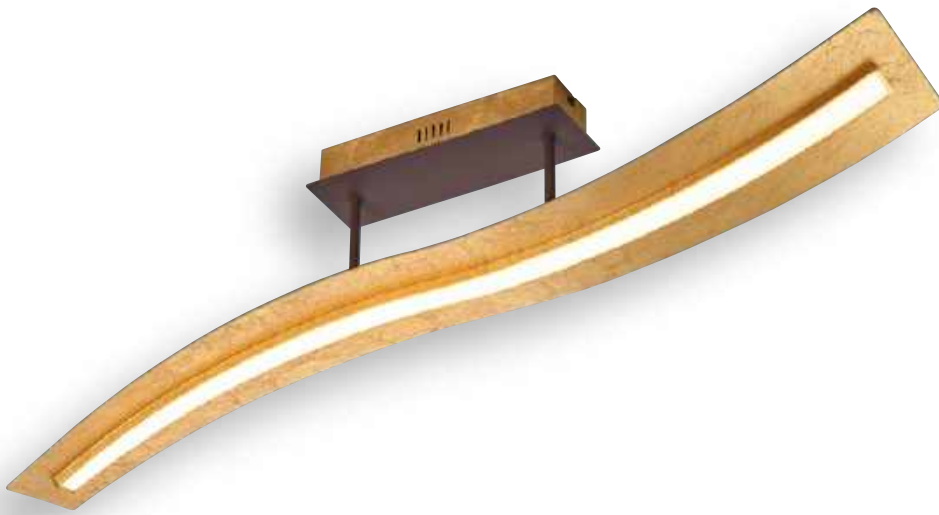

SALERNO

Metall, goldfarbig/rost · metal, gold/rusty ·
 metale, or/rouille · metaal, goud/roestkleur · metal, oro/óxido ·
 metallo, oro/ruggine · metal, aur/ruginiu · metalli, kultaa/rustiikki ·
 metal, złota/miedź

LED SWITCHDIMMER

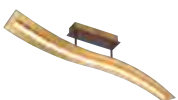

↔ 90 x 12 cm, ↓ 27,5 cm
 incl. SMD-LED, 24 W
 2.400 lm, 3.000 K



624610179



↔ 115 x 12 cm, ↓ 150 cm
 incl. SMD-LED, 35 W
 3.500 lm, 3.000 K



324610179



↓ 140 cm, ↔ 22 x 22 cm
 incl. SMD-LED, 31 W
 2.900 lm, 3.000 K



424610179





LED SWITCHDIMMER



RONDO

Metall, Weiß matt oder Schwarz matt · metal, white mat or black mat ·
 metale, blanc mat ou noir mat · metaal, wit mat of mat zwart ·
 metal, estera blanca o estera negra · metallo, bianco opaco o nero opaco ·
 metal, alb mat sau negru mat · metalli, mattavalkoinen tai mattamusta ·
 metal, biały mat lub czarny mat



↓ 150 cm, ↔ 30 cm
 incl. SMD-LED, 22 W
 1.950 lm, 3.000 K



322610231
 322610232



↔ 110 x 30 cm, ↑ 150 cm
 incl. SMD-LED, 37 W
 3.300 lm, 3.000 K



322610431
 322610432



↔ 97 x 34 cm, ↓ 5,5 cm
 incl. SMD-LED, 37 W
 3.300 lm, 3.000 K



622610431
 622610432



↓ 45 cm, ↔ 21 cm
 incl. SMD-LED, 17 W
 1.500 lm, 3.000 K



522610331
 522610332



↓ 115 cm, ↔ 47 cm
 incl. SMD-LED, 36 W
 3.200 lm, 3.000 K



422610531
 422610532



LED SWITCH DIMMER



- 31 Weiß matt · white mat
- 32 Schwarz matt · black mat



AVUS

Nickel matt oder Schwarz matt · nickel mat or black mat ·
 nickel mat ou noir mat · nikkell mat of mat zwart ·
 níquel mate o estera negra · nichel opaco o nero opaco ·
 nichel mat sau negru mat · harjattu teräs tai musta matto ·
 nikiel mat lub czarny mat

LED SWITCHDIMMER

106



↔ 90 x 25 cm, ↑ 9 cm
 incl. SMD-LED, 35 W
 3.700 lm, 3.000 K



629010107
 629010132



↑ 150 cm, ↔ 110 cm
 incl. SMD-LED, 35 W
 3.700 lm, 3.000 K



329010107
 329010132



↑ 112 cm, ↔ 29 cm
 incl. SMD-LED, 35 W
 3.700 lm, 3.000 K



429010107
 429010132



07 Nickel matt · nickel mat
32 Schwarz matt · black mat





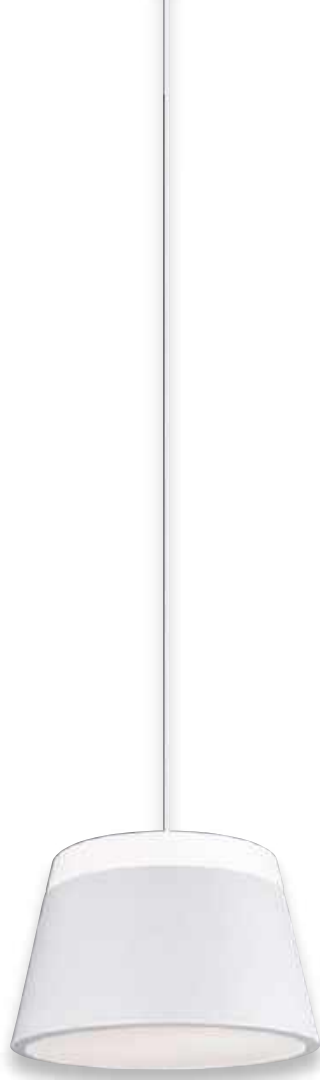

BARONESS

Metall, Weiß matt oder Anthrazit, Acryl weiß · metal, white mat or anthracite, acryl white ·
metale, blanc mat ou antracite, acryl blanc · metaal, wit mat of antraciet, acryl wit ·
metal, estera blanca o antracita, acrílico blanco · metallo, bianco opaco o antracite,
acrilico bianco · metal, alb mat sau antracit, acrilic alb · metalli, mattavalkoinen tai
antrasiitti, akryyli valkoinen · metal, biały mat lub antracyt, akryl biały



108



↓ 150 cm, Ø 25 cm
excl. 2 x E14, max. 15 W



308900231
308900242



↓ 150 cm, Ø 45 cm
excl. 3 x E27, max. 15 W



308900331
308900342



↓ 150 cm, Ø 45 cm
excl. 3 x E27, max. 15 W



408900331
408900342



31 Weiß matt · white mat
42 Anthrazit · anthracite







BARONESS

Metall, Weiß matt oder Anthrazit, Acryl weiß · metal, white mat or anthracite, acryl white ·
 metale, blanc mat ou antracite, acryl blanc · metaal, wit mat of antraciet, acryl wit ·
 metal, estera blanca o antracita, acrílico blanco · metallo, bianco opaco o antracite, acrilico bianco ·
 metal, alb mat sau antracit, acrilic alb · metalli, mattavalkoinen tai antrasiitti, akryyli valkoinen ·
 metal, biały mat lub antracyt, akryl biały

110



Ø 45 cm, ↑ 23 cm
 excl. 3 x E27, max. 15 W



608900331
 608900342



↑ 45 cm, Ø 25 cm
 excl. 2 x E14, max. 15 W



508900231
 508900242



↔ 105 cm, ↑ 150 cm, Ø 25 cm
 excl. 6 x E14, max. 15 W



308900631
 308900642



31 Weiß matt · white mat
 42 Anthrazit · anthracite







32

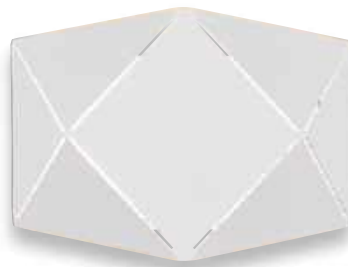

31

ZANDOR

Metall, Weiß matt oder Schwarz matt, Acryl · metal, white mat or black mat, acryl ·
 metale, blanc mat ou noir mat, acryl · metaal, wit mat of mat zwart, acryl ·
 metal, estera blanca o estera negra, acrílico · metallo, bianco opaco o nero opaco, acrilico ·
 metal, alb mat sau negru mat, acrilic · metalli, mattavalkoinen tai mattamusta, akryyli ·
 metal, biały mat lub czarny mat, akryl



Ø 50 cm, ↑ 150 cm
 excl. 3 x E27, max. 25 W



303500331
 303500332



Ø 40 cm, ↑ 15 cm
 excl. 3 x E27, max. 25 W



603500331
 603500332



↔ 40 x 13 cm, ↗ 6
 incl. 1 x SMD-LED, 13 W
 1.000 lm, 3.000 K

223510231
 223510232



↔ 18 x 13 cm, ↗ 6 cm
 incl. 1 x SMD-LED, 6,5 W
 500 lm, 3.000 K

223510131
 223510132



31 Weiß matt · white mat
 32 Schwarz matt · black mat







BARON

Metall, Weiß matt oder Schwarz matt, Acryl · metal, white mat or black mat, acryl ·
metale, blanc mat ou noir mat, acryl · metaal, wit mat of mat zwart, acryl ·
metal, estera blanca o estera negra, acrílico · metallo, bianco opaco o nero opaco, acrilico ·
metal, alb mat sau negru mat, acrilic · metalli, mattavalkoinen tai mattamusta, akryyli ·
metal, biały mat lub czarny mat, akryl



Ø 52 cm, ↑ 24 cm
excl. 4 x E27, max. 40 W



609800431
609800432



Ø 52 cm, ↑ 150 cm
excl. 4 x E27, max. 40 W



309800431
309800432



31 Weiß matt · white mat
32 Schwarz matt · black mat



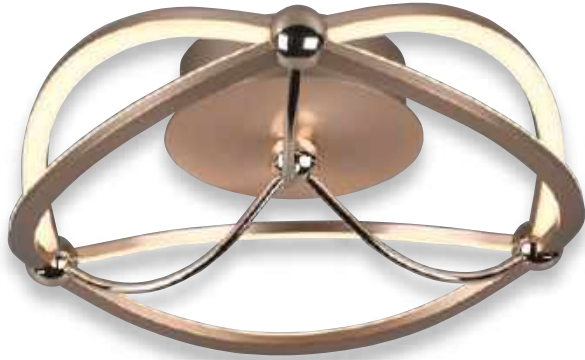

LED SWITCHDIMMER

CHARIVARI

Nickel matt oder Messing matt · nickel mat or brass mat ·
 nickel mat ou laiton mat · nikkell mat of messing mat ·
 níquel mate o bronz mate · nichel opaco o ottone satinato ·
 nichel mat sau bronz mat · harjattu teräs tai mattamessinki ·
 nikiel mat lub mosiądz mat



Ø 62 cm, ↑ 150 cm
 incl. SMD-LED, 42 W
 5.100 lm, 3.000 K



321210107
 321210108



Ø 41 cm, ↓ 14 cm
 incl. SMD-LED, 20 W
 2.500 lm, 3.000 K



621210107
 621210108



Ø 62 cm, ↓ 18 cm
 incl. SMD-LED, 42 W
 5.100 lm, 3.000 K



621290107
 621290108



↓ 50 cm, Ø 41 cm
 incl. SMD-LED, 20 W
 2.500 lm, 3.000 K



521210107
 521210108



↓ 175 cm, Ø 52 cm
 incl. SMD-LED, 31 W
 3.700 lm, 3.000 K



421210107
 421210108

LED SWITCHDIMMER



- 07 Nickel matt · nickel mat
- 08 Messing matt · brass mat





LED SWITCHDIMMER

PORTOFINO

Chrom, Acryl · chrome, acryl ·
 chrome, acryl · chroom, acryl · cromo, acrílico · cromo, acrilico ·
 crom, acrilic · kromi, akryyli · chrom, akryl



↔ 149 cm, ↑ 14 cm
 incl. 4 x SMD-LED, 7 W
 4 x 700 lm, 3.000 K



676310206



↑ 85 cm, Ø 16 cm
 incl. 2 x SMD-LED, 8 W
 2 x 800 lm, 3.000 K



576390206



↑ 155 cm, Ø 21 cm
 incl. 2 x SMD-LED, 12 W
 2 x 1.200 lm, 3.000 K



476310206



↔ 149 cm, ↑ 150 cm
 incl. 4 x SMD-LED, 7 W
 4 x 700 lm, 3.000 K



376310406



LED SWITCHDIMMER



SYDNEY

Chrom, Acryl · chrome, acryl ·
 chrome, acryl · chroom, acryl · cromo, acrílico · cromo, acrilico ·
 crom, acrilic · kromi, akryyli · chrom, akryl



↔ 103 cm, ↓ 80 - 130 cm
 incl. SMD-LED, 20 W
 1.800 lm, 3.000 K

↔ 103 cm, ↓ 27 cm
 incl. SMD-LED, 20 W
 1.800 lm, 3.000 K

↑ 63 cm, Ø 20 cm
 incl. SMD-LED, 14,5 W
 1.300 lm, 3.000 K

↑ 162 cm, Ø 25 cm
 incl. SMD-LED, 20 W
 1.800 lm, 3.000 K



372910106



672910106



572910106



472910106





OLYMPUS

Chrom, Aluminium · chrome, aluminium ·
chrome, aluminium · chroom, aluminium ·
cromo, aluminio · cromo, alluminio · crom, aluminu ·
kromi, alumiini · chrom, aluminium



Ø 54 cm, ↓ 26,5 cm
incl. 6 x SMD-LED, 4,2 W
6 x 450 lm, 3.000 K



670910606



↔ 115 x 17,5 cm, ↓ 150 cm
incl. 6 x SMD-LED, 4,2 W
6 x 450 lm, 3.000 K



370910606



↓ 60 cm, ↔ 17,5 cm,
incl. 2 x SMD-LED, 4,2 W
2 x 450 lm, 3.000 K



570990206



↓ 165 cm, ↔ 21 cm
incl. 4 x SMD-LED, 4,2 W
4 x 450 lm, 3.000 K



470910406

LED SWITCHDIMMER



LOOP

Nickel matt · nickel mat ·
nickel mat · nikkell mat · níquel mate · nichel opaco ·
nichel mat · harjattu teräs · nikiel mat



124



↔ 117 x 15 cm, ↓ 150 cm
incl. 3 x SMD-LED, 9 W
3 x 850 lm, 3.000 + 5.000 K



379890307



↑ 57 cm, Ø 16 cm
incl. 3 x SMD-LED, 4,5 W
3 x 300 lm, 3.000 + 5.000 K



579890307



↑ 138 cm, Ø 23 cm
incl. 3 x SMD-LED, 9 W
3 x 850 lm, 3.000 + 5.000 K



479890307





CATOKI

Chrom, Acryl · chrome, acryl ·
chrome, acryl · chroom, acryl · cromo, acrílico ·
cromo, acrílico · crom, acrílic · kromi, akryyli ·
chrom, akryl



125



↔ 110 x 16 cm, ↑ 11 cm
incl. SMD-LED, 32 W
3.000 lm, 3.000 K



676413606



↔ 60 x 15,5 cm, ↑ 6 cm
incl. SMD-LED, 24 W
2.200 lm, 3.000 K

676412406



↑ 35 cm, Ø 12,5 cm
incl. SMD-LED, 6 W
600 lm, 3.000 K



576410806



MARIUS

Aluminium gebürstet, Chrom · brushed aluminium, chrome · aluminium balayé, chrome · geborsteld aluminium, chroom · aluminio pulido, cromo · alluminio spazzolato, cromo · aluminiu lucios, crom · harjattu alumiini, kromi · aluminium szczotkowane, chrom

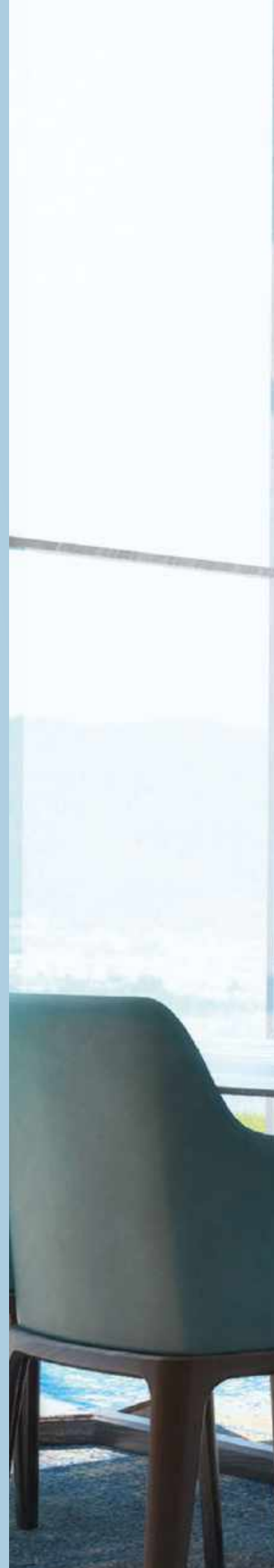

↓ 42 x 10 cm, ↗ 9 cm
incl. 1 x SMD-LED, 10 W
900 lm, 3.000 K



274191005



↓ 132 cm, ↔ 15 x 25 cm
incl. 1 x SMD-LED, 25 W
2.300 lm, 3.000 K



474112505



↔ 100 x 3,5 cm, ↓ 150 cm
incl. 1 x SMD-LED, 25 W
2.300 lm, 3.000 K



374112505



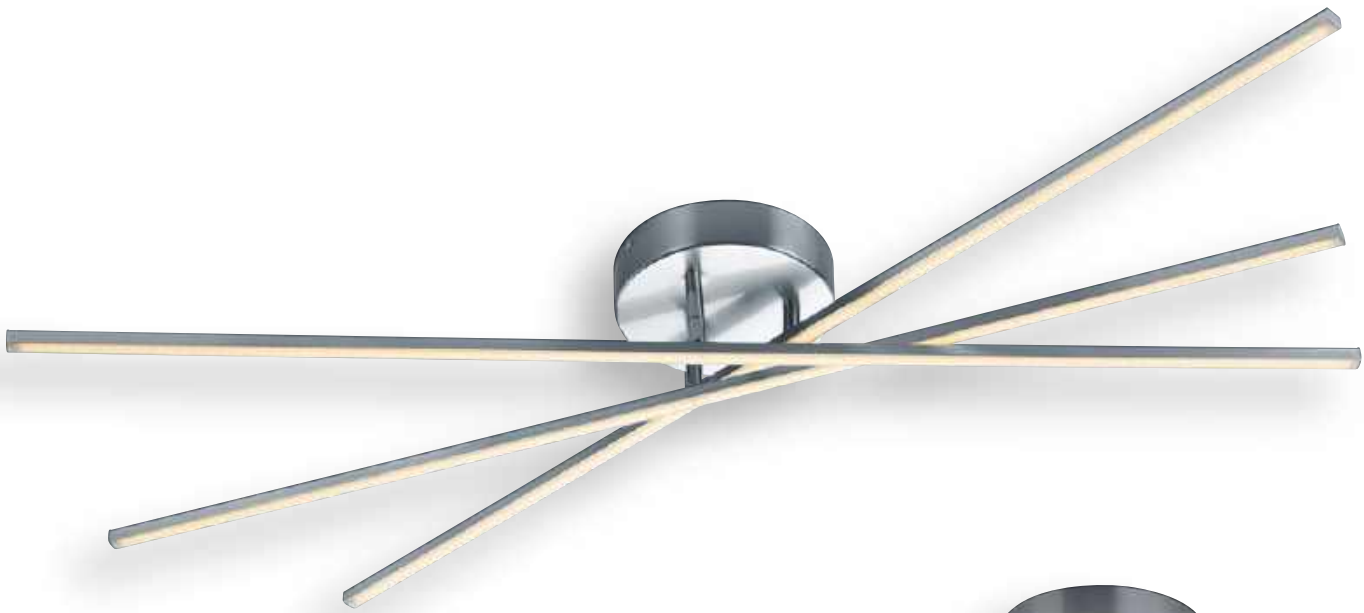

TIRIAC

Nickel matt oder Weiß matt · nickel mat or white mat ·
 nickel mat ou blanc mat · nikkell mat of wit mat ·
 níquel mate o estera blanca · nichel opaco o bianco opaco ·
 nichel mat sau alb mat · harjattu teräs tai valkoinen matto ·
 nikiel mat lub biały mat

LED SWITCHDIMMER

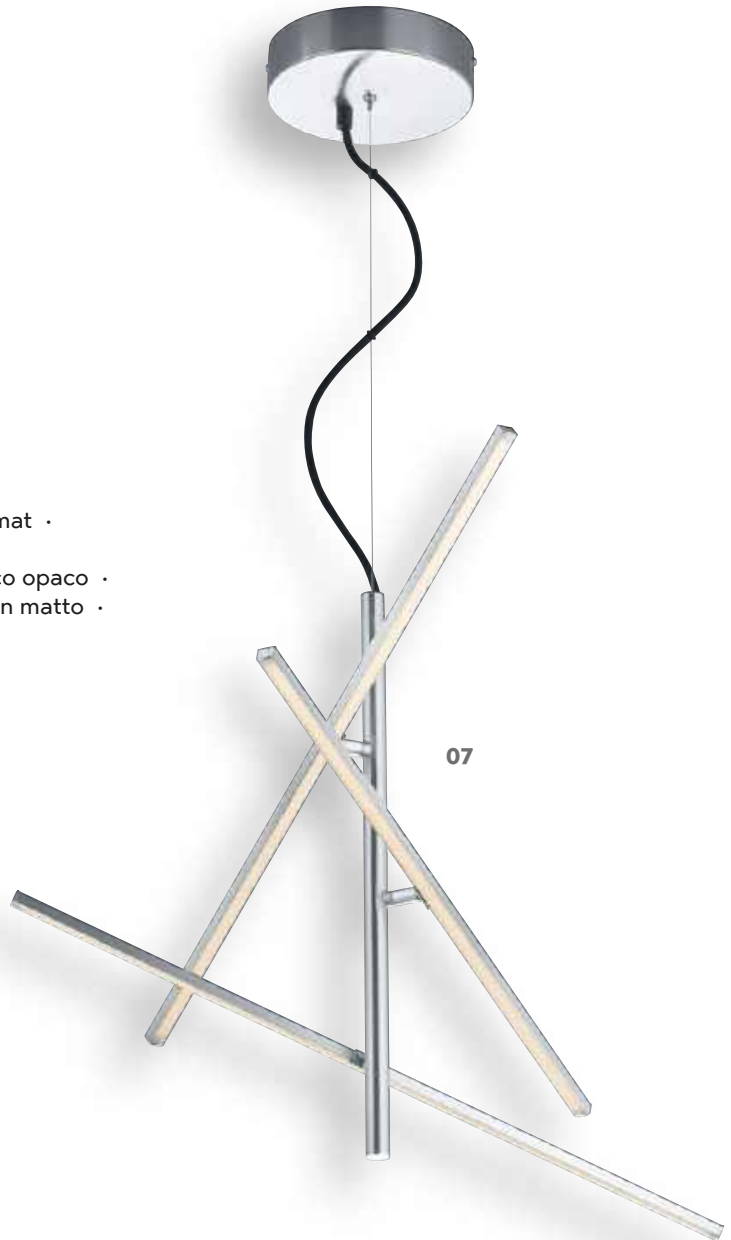

07

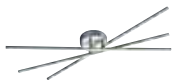

↔ 100 cm, ↓ 12 cm
 incl. 3 x SMD, 8,5 W
 3 x 950 lm, 3.000 K

↔ 60 cm, ↑ 150 cm
 incl. 3 x SMD, 7,5 W
 3 x 830 lm, 3.000 K

↔ 100 cm, ↓ 150 cm
 incl. 3 x SMD, 8,5 W
 3 x 950 lm, 3.000 K



671610307
 671610331

371690307
 371690331

371610307
 371610331

07 Nickel matt · nickel mat
 31 Weiß matt · white mat



31



SILAS

Aluminium gebürstet · brushed aluminium ·
aluminium balayé · geborsteld aluminium · aluminio pulido ·
alluminio spazzolato · aluminiu lucios · harjattu alumiini ·
aluminium szczotkowane



4 fach Touch
4 level touch

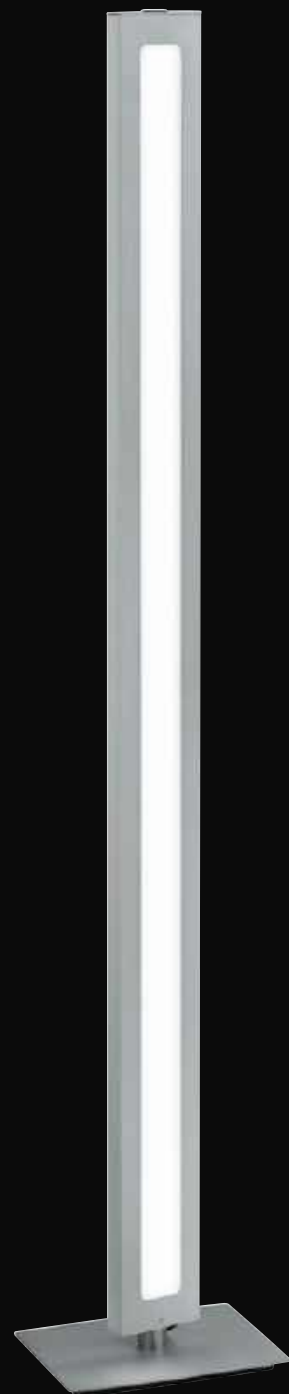

↔ 115 x 8 cm, ↑ 150 cm
incl. SMD-LED, 45 W
4.500 lm, 3.000 K



372294505



↔ 80 x 8 cm, ↑ 6 cm
incl. SMD-LED, 24 W
2.400 lm, 3.000 K



672212405



↔ 20 x 15 cm, ↑ 116 cm
incl. SMD-LED, 20 W
1.800 lm, 3.000 K



472290105



LED SWITCHDIMMER



Ø 25 cm, ↑ 150 cm
incl. SMD-LED, 22 W
2.000 lm, 3.000 K



378310106



↑ 180 cm, ↗ 52 cm
incl. 1 x SMD-LED, 22 W , 2.000 lm, 3.000 K
incl. 1 x SMD-LED, 3,8 W , 350 lm, 3.000 K



478310206



↑ 200 cm, ↗ 61 cm
incl. 5 x SMD-LED, 3,8 W
5 x 350 lm, 3.000 K



478310506



CHRIS

Chrom, Acryl mit Kristalleffekt · chrome, broken glass optic ·
chrome, optique verre pilé · chroom, gebroken glas optiek ·
cromo, efecto cristal roto · cromo, effetto ottico vetro rotto ·
chrom, aspect de sticla sparta · kromi, lasi efekti optiikka ·
chrom, optyczne rozbite szkło



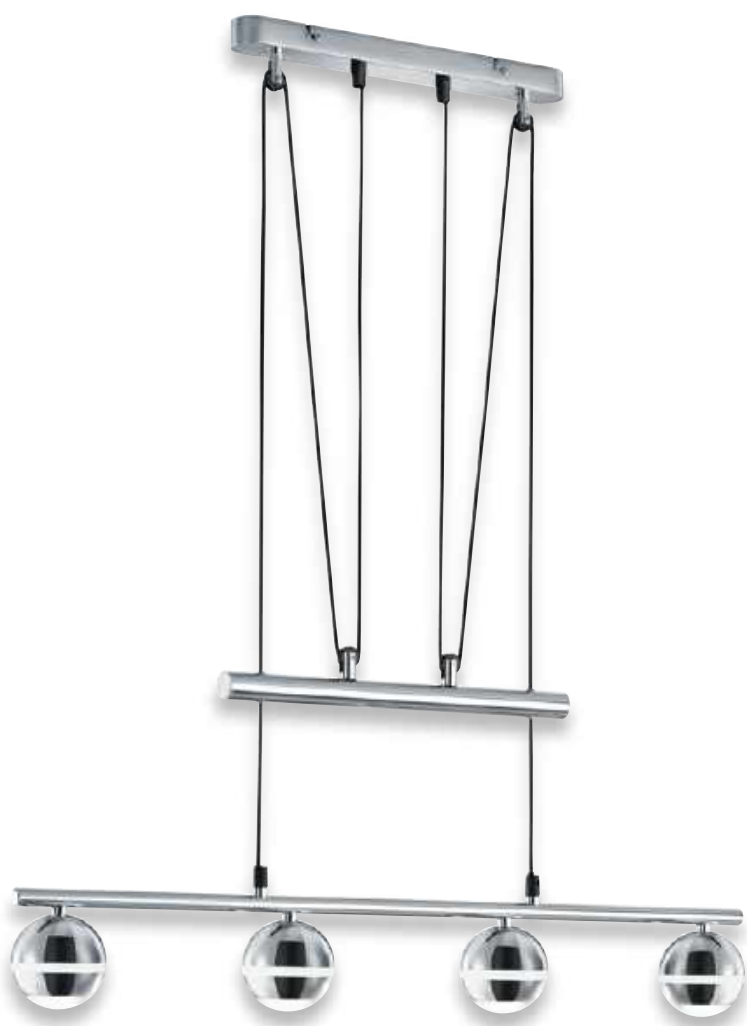

BALOUBET

Chrom, Kunststoff/Metall · chrome, plastic/metal ·
 chrome, plastique/metale · chroom, kunststof/metaal ·
 cromo, plástico/metal · cromo, plastica/metallo ·
 crom, plastic/metal · kromi, muovi/metalli ·
 chrom, plastik/metal



↔ 75 x 45 cm, ↓ 25 cm
 incl. 5 x SMD-LED, 3,8 W
 5 x 350 lm, 3.100 K

628290506



↔ 75 cm, ↓ 79 - 180 cm
 incl. 4 x SMD-LED, 3,8 W
 4 x 350 lm, 3.100 K



328210406



↓ 35 cm, ↗ 22 cm
 incl. 1 x SMD-LED, 3,8 W
 350 lm, 3.100 K



528210106



↓ 125 cm, ↗ 45 cm
 incl. 2 x SMD-LED, 3,8 W
 2 x 350 lm, 3.100 K



428210206





LED SWITCHDIMMER



LED SWITCHDIMMER



AGENTO

Nickel matt oder Messing matt, Stoff · nickel mat or brass mat, fabric ·
 nickel mat ou laiton mat, tissu · nikkell mat of messing mat, textiel ·
 níquel mate o bronz mate, tela · nichel opaco o ottone satinato, tessuto ·
 nichel mat sau bronz mat, textil · harjattu teräs tai mattamessinki, tekstiili ·
 nikiel mat lub mosiądz mat, tkanina



↑ 18 x 16 cm, ↗ 7 cm
 incl. 1 x SMD-LED, 5,5 W
 550 lm, 3.000 K



278070107
278070108



↑ 32 cm, Ø 20 cm
 incl. 1 x SMD-LED, 7,5 W
 750 lm, 3.000 K



578090107
578090108



Ø 40 cm, ↑ 10 cm
 incl. 1 x SMD-LED, 24 W
 2.100 lm, 3.000 K



678010107
678010108



↔ 90 x 20 cm, ↓ 95 - 160 cm
 incl. 3 x SMD-LED, 7,5 W
 3 x 750 lm, 3.000 K



378010307
378010308



↔ 115 x 20 cm, ↓ 95 - 160 cm
 incl. 4 x SMD-LED, 7,5 W
 4 x 750 lm, 3.000 K



378010407
378010408



Innovative Höhenverstellung ohne Gegengewicht · Innovative height adjustment without counterweight · Nouveau! Réglage de la hauteur sans contrepoids · Innovatieve hoogteverstelling zonder contragewicht · Innovador sistema de ajuste de altura sin necesidad de contrapeso · Regolazione innovativa dell'altezza senza contrappeso · Ajustare inovativa a inaltimii fara contragreutate · Innovatiivinen korkeuden säätö ilman vastapainoa · Innowacyjna regulacja wysokości bez przeciwwagi



LED SWITCHDIMMER



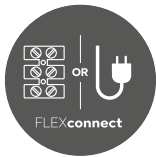

Seite/page 685

LYON

Nickel matt oder Messing matt, Stoffschirm ·
 nickel mat or brass mat, fabric shade ·
 nickel mat ou laiton mat, abat-jour tissu ·
 nikkell mat of messing mat, Stoffen kap ·
 níquel mate o bronze mate, Pantalla de tela ·
 nichel opaco o ottone satinato, paralume in tessuto ·
 nichel mat sau bronz mat, abajur textil ·
 harjattu teräs tai mattamessinki, kangas varjostin ·
 nikiel mat lub mosiądz mat, Klosz z materiafu



07

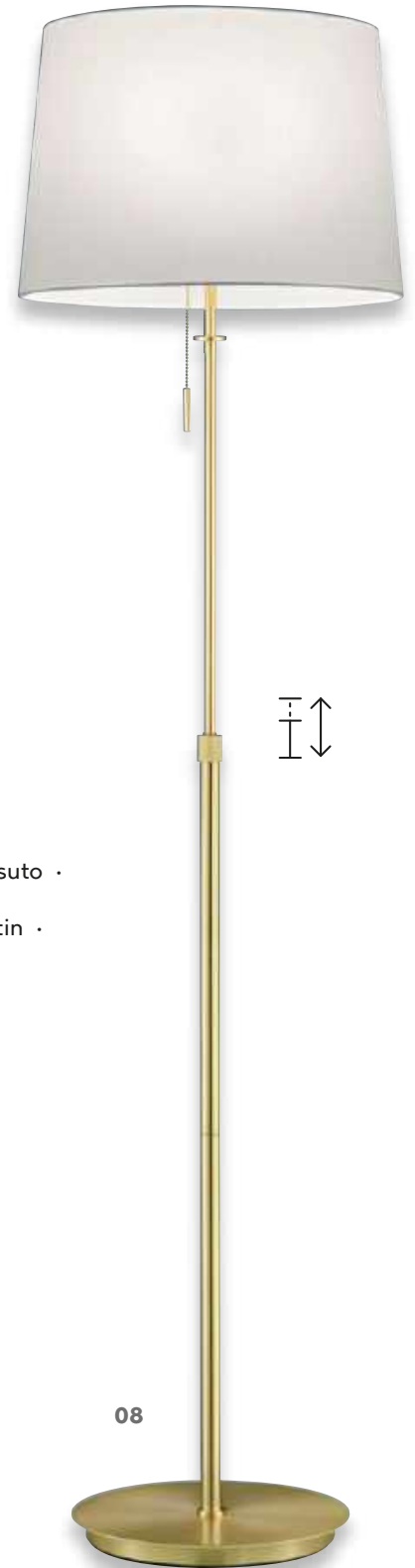

08



↑ 32 cm, ↗ 69 cm
 excl. 1 x E27, max. 60 W



209100107
 209100108



↑ 45 - 56 cm, Ø 25,5 cm
 excl. 1 x E27, max. 60 W



509100107
 509100108



↑ 138 - 180 cm, Ø 46 cm
 excl. 3 x E27, max. 60 W

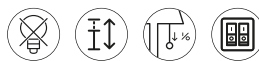

409100307
 409100308



07 Nickel matt · nickel mat
 08 Messing matt · brass mat



Getrennt schaltbar · Separately switchable ·
Interrupteurs séparés · Gescheiden schakelbaar ·
Interruptores separados · Interruttori separati ·
Intrerupatoare separate · Erikseen kytkettävissä ·
Oddzielny przełącznik



LED SWITCHDIMMER



11



01

LUGANO

Nickel matt, Stoffschirm · nickel mat, fabric shade ·
nickel mat, abat-jour tissu · nikkel mat, Stoffen kap ·
níquel mate, Pantalla de tela · nichel opaco, paralume in tessuto ·
nichel mat, abajur textil · harjattu teräs, kangas varjostin ·
nikiel mat, Klosz z materiału

140



↔ 25 x 8 cm, ↗ 7,5 cm
incl. SMD-LED, 6 W
580 lm, 3.000 K



271970601
271970611



↔ 100 x 8,5 cm, ↓ 150 cm
incl. SMD-LED, 18 W
1.500 lm, 3.000 K



320910101
320910111



01 Weiß · white
11 Grau · grey

LED SWITCHDIMMER



75 cm



LUGANO

Stoffschirm, Acryl · fabric shade, acryl ·
abat-jour tissu, acryl · Stoffen kap, acryl · Pantalla de tela, acrílico ·
paralume in tessuto, acrilico · abajur textil, acrilic · kangas varjostin, akryyli ·
Klosz z materiału, akryl



Ø 60 cm, ↑ 10 cm
incl. SMD-LED, 40 W
3.300 lm, 3.000 - 5.000 K



621914001
621914011



Ø 75 cm, ↑ 10 cm
incl. SMD-LED, 60 W
5.000 lm, 3.000 - 5.000 K



621915501
621915511



01 Weiß · white
11 Grau · grey



LED SWITCHDIMMER

LUGANO

Stoffschirm, Acryl · fabric shade, acryl ·
abat-jour tissu, acryl · Stoffen kap, acryl · Pantalla de tela, acrílico ·
paralume in tessuto, acrilico · abajur textil, acrilic · kangas varjostin, akryyli ·
Klosz z materiału, akryl

143



Ø 30 cm, ↑ 9 cm
incl. SMD-LED, 11 W
1.100 lm, 3.000 K

621911201
621911211

Ø 40 cm, ↑ 10,5 cm
incl. SMD-LED, 22 W
2.200 lm, 3.000 K



621912401
621912411



01 Weiß · white
11 Grau · grey

COSINUS

Nickel matt, Stoff · nickel mat, fabric ·
nickel mat, tissu · nikkel mat, textiel ·
níquel mate, tela · nichel opaco, tessuto ·
nichel mat, textil · harjattu teräs, tekstiili ·
nikiel mat, tkanina



Ø 40 cm, ↓ 150 cm
excl. 1 x E27, max. 60 W



306500107



↓ 35 cm, Ø 20 cm
excl. 1 x E14, max. 40 W



506500107



↓ 55 cm, Ø 30 cm
excl. 1 x E27, max. 60 W



556500107



↓ 155 cm, Ø 40 cm
excl. 1 x E27, max. 60 W



406500107





WAILER

Metall, Nickel matt oder Schwarz matt, Stoffschirm · metal, nickel mat or black mat, fabric shade ·
 metale, nickel mat ou noir mat, abat-jour tissu · metaal, nikkel mat of mat zwart, Stoffen kap ·
 metal, níquel mate o estera negra, Pantalla de tela · metallo, nichel opaco o nero opaco, paralume in tessuto ·
 metal, nichel mat sau negru mat, abajur textil · metalli, harjattu teräs tai mattamusta, kangas varjostin ·
 metal, nikiel mat lub czarny mat, Klosz z materiału

Empfohlen:
 recommended: LED GU10, 5 W
 400 lm, 3.000 K



956-55



↓ 12 x 16 cm, ↗ 21 cm
 excl. 1 x GU10, max. 5 W



803670107
 803670132



↔ 44 x 16 cm, ↓ 21 cm
 excl. 2 x GU10, max. 5 W



803600207
 803600232



↔ 66 x 16 cm, ↓ 21 cm
 excl. 3 x GU10, max. 5 W



803600307
 803600332



Ø 12 cm, ↓ 150 cm
 excl. 1 x GU10, max. 5 W



303600107
 303600132



↔ 80 x 12 cm, ↓ 150 cm
 excl. 4 x GU10, max. 5 W



303600407
 303600432



Ø 35 cm, ↑ 150 cm
excl. 3 x GU10, max. 5 W



303690307
303690332

07 Nickel matt · nickel mat
32 Schwarz matt · black mat



HOTEL

Nickel matt, Stoff · nickel mat, fabric ·
 nickel mat, tissu · nikkell mat, textiel · níquel mate, tela ·
 nichel opaco, tessuto · nichel mat, textil · harjattu teräs, tekstiili ·
 nikiel mat, tkanina



↓ 170 cm, Ø 40 cm, √ 35 cm
 excl. 1 x E27, max. 60 W
 excl. 1 x E14, max. 18 W



403900201
 403900211



↓ 150 - 215 cm, Ø 30 cm, √ 107 cm
 excl. 1 x E27, max. 60 W



461100101
 461100102
 461100114



01 Weiß · white
 02 Schwarz · black
 11 Grau · grey
 14 Braun · brown



Ø 40 cm, ↓ 150 cm
excl. 1 x E27, max. 60 W



303300101
303300102
303300114



↓ 32 cm, Ø 20 cm
excl. 1 x E14, max. 40 W



501100101
501100102
501100114



↓ 55 cm, Ø 30 cm
excl. 1 x E27, max. 60 W



511100101
511100102
511100114



↓ 160 cm, Ø 35 cm
excl. 1 x E27, max. 60 W



401100101
401100102
401100114



01 Weiß · white
02 Schwarz · black
14 Braun · brown

14



02



01



HOTEL

Nickel matt, Stoff · nickel mat, fabric ·
nickel mat, tissu · nikkel mat, textiel · níquel mate, tela ·
nichel opaco, tessuto · nichel mat, textil · harjattu teräs, tekstiili ·
nikiel mat, tkanina



Ø 30 cm, ↑ 16 cm
excl. 2 x E14, max. 40 W



603900201
603900202
603900214



Ø 50 cm, ↑ 20,5 cm
excl. 3 x E27, max. 60 W



603900301
603900302
603900314



Ø 65 cm, ↑ 17 cm
excl. 5 x E27, max. 60 W



603900501
603900502
603900514



01 Weiß · white
02 Schwarz · black
14 Braun · brown



HOTEL

Stoffschilder · fabric shade ·
abat-jour tissu · Stoffen kap · Pantalla de tela · paralume in tessuto ·
abajur textil · kangas varjostin · Klosz z materiału

151



↔ 50 x 47 cm, ↑ 21,5 cm
excl. 4 x E27, max. 42 W



693900417

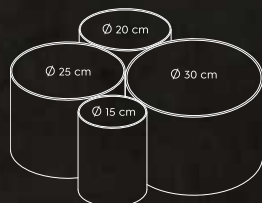

↔ 90 x 70 cm, ↑ 21,5 cm
excl. 5 x E27, max. 42 W



693900517

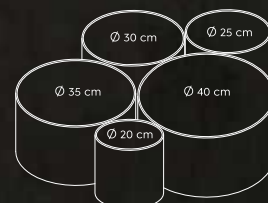

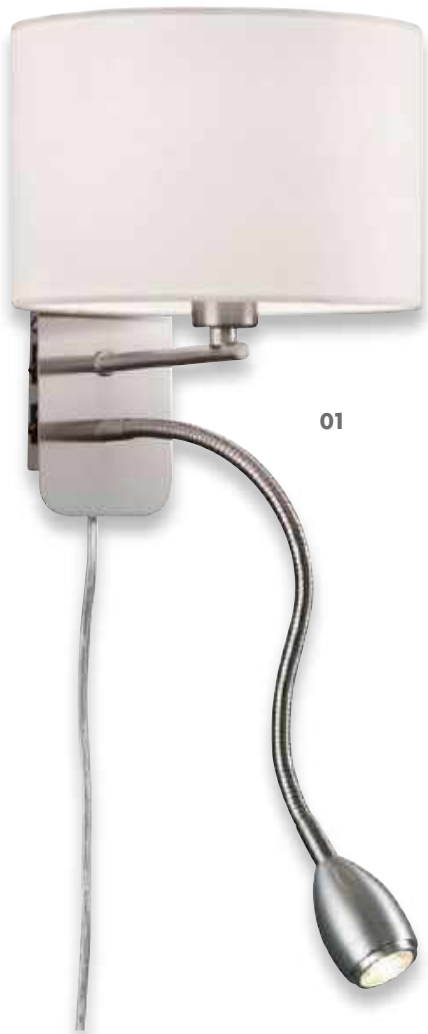

01



14

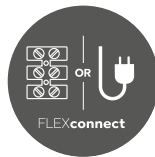

Seite/page 685

HOTEL

Nickel matt, Stoff · matt nickel, fabric
 Nickel mat, Textil · Mat nikel, Kumaş · Nikiel mat, material ·
 Harjattu teräs, Tekstiili · Níquel mate, Tela · Nichel opaco, Tessuto ·
 Nickel mat, Tissu



01



↔ 20 x 27 cm, ∠ max. 40 cm
 incl. 1 x SMD-LED, 3,1 W
 310 lm, 3.000 K
 excl. 1 x E14, max. 40 W



271370201
 271370211
 271370214



↓ 23,5 cm, Ø 20 cm, ∠ max. 34,5 cm
 incl. 1 x COB-LED, 3,2 W
 300 lm, 3.000 K
 excl. 1 x E14, max. 40 W



271170201
 271170202
 271170214



01 Weiß · white
 02 Schwarz · black
 11 Grau · grey
 14 Braun · brown



11



ANDREUS

Metall, Weiß matt oder Schwarz matt, Stoffschirm · metal, white mat or black mat, fabric shade ·
 metale, blanc mat ou noir mat, abat-jour tissu · metaal, wit mat of mat zwart, Stoffen kap ·
 metal, estera blanca o estera negra, Pantalla de tela · metallo, bianco opaco o nero opaco,
 paralume in tessuto · metal, alb mat sau negru mat, abajur textil · metalli, mattavalkoinen tai
 mattamusta, kangas varjostin · metal, biały mat lub czarny mat, Klosz z materiału

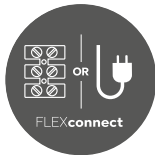

Seite/page 685



Ø 15 cm, ↑ 26,5 cm, ↗ 19,5 cm
 excl. 1 x E14, max. 40 W



207500179
 207500189



Ø 35 cm, ↑ 150 cm
 excl. 1 x E27, max. 60 W



307500179
 307500189



↔ max. 235 cm, ↑ max. 150 cm
 excl. 2 x E27, max. 60 W



307500279
 307500289



↓ 50 cm, Ø 16 cm, ↗ 32 cm
 excl. 1 x E14, max. 40 W



507500179
 507500189



↑ 180 cm, Ø 35 cm, ↗ 80 cm
 excl. 1 x E27, max. 60 W



407500179
 407500189



79 goldfarbig, Schwarz matt · gold, black mat
89 silberfarbig, Weiß mat · silver, white mat



HOSTEL

Metall, Stoffschirm · metal, fabric shade ·
 metale, abat-jour tissu · metaal, Stoffen kap ·
 metal, Pantalla de tela · metallo, paralume in tessuto ·
 metal, abajur textil · metalli, kangas varjostin ·
 metal, Klosz z materiału



Ø 30 cm, ↓ 22 cm
 excl. 2 x E14, max. 40 W



608200279



Ø 40 cm, ↓ 150 cm
 excl. 1 x E27, max. 60 W



308200179
 308200189



↓ 33 cm, Ø 20 cm
 excl. 1 x E27, max. 60 W



508200179



↓ 160 cm, Ø 35 cm
 excl. 1 x E27, max. 60 W



408200179



↓ max. 156 cm, Ø 35 cm, ↗ max. 63 cm
 excl. 1 x E27, max. 60 W



408290179



79 goldfarbig · gold
89 silberfarbig · silver



↓ 18 cm, Ø 9,5 cm
excl. 1 x E14, max. 40 W



595400101
595400111
595400141
595400179
595400189



↔ 75 x 44,2 cm, ↓ 22 cm
excl. 5 x E14, max. 40 W



605400501
605400511
605400541
605400579
605400589



↔ 77 x 13,5 cm, ↓ 95 - 150 cm
excl. 4 x E14, max. 40 W



305400401
305400411
305400441
305400479
305400489



01 Weiß · white
11 Grau · grey
41 Taupe · taupe
79 goldfarbig · gold
89 silberfarbig · silver



GARDA

Nickel matt, Stoffschirm · nickel mat, fabric shade ·
 nickel mat, abat-jour tissu · nikkell mat, Stoffen kap ·
 níquel mate, Pantalla de tela · nichel opaco, paralume in tessuto ·
 nichel mat, abajur textil · harjattu teräs, kangas varjostin ·
 nikiel mat, Klosz z materiału





IBIS

Stoffschirm, Nickel matt · fabric shade, nickel mat ·
abat-jour tissu, nickel mat · Stoffen kap, nikkel mat ·
Pantalla de tela, níquel mate · paralume in tessuto, nichel opaco ·
abajur textil, nichel mat · kangas varjostin, harjattu teräs ·
Klosz z materiału, nikiel mat

160



Ø 45 cm, ↓ 39,6 cm
excl. 3 x E27, max. 40 W



609400317



↓ 150 cm, Ø 45 cm
excl. 3 x E27, max. 40 W



309400317





Ø 40 cm, ↑ 22 cm
excl. 5 x G9, max. 42 W



611210506



Ø 40 cm, ↑ 150 cm
excl. 5 x G9, max. 42 W



311210506



Ø 50 cm, ↑ 150 cm
excl. 6 x G9, max. 42 W



311210606



Ø 28 cm, ↑ 43 cm
excl. 3 x G9, max. 42 W



511210306

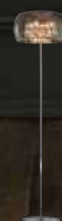

Ø 40 cm, ↑ 158 cm
excl. 4 x G9, max. 42 W



411210406



VAPORE

Chrom, Glas chrom bedampft · chrome, chroom plated glass ·
chrome, verre plaqué chrome · chroom, chroom opgedampt glas ·
cromo, vidrio cromado · cromo, vetro verniciato cromo ·
crom, sticla cromata · kromi, kromipäällystetty lasi ·
chrom, szkło chromowane





LUCERNA

Chrom, Acryl · chrome, acryl ·
 chrome, acryl · chroom, acryl · cromo, acrílico · cromo, acrílico ·
 crom, acrylic · kromi, akryyli · chrom, akryl

Empfohlen:
 recommended: Filament LED E14, 4 W
 470 lm, 3.000 K



990-400



↔ 33 x 22 cm, ↗ 19 cm
 excl. 2 x E14, max. 40 W



201600206



Ø 52 cm, ↓ 150 cm
 excl. 5 x E14, max. 40 W



101600506



Ø 68,6 cm, ↓ 150 cm
 excl. 8 x E14, max. 40 W



101600806





FARO

Chrom, Glas Schwarz matt, innen goldfarbig · chrome, glass black mat, gold colored inside ·
chrome, verre noir mat, Or · chroom, glas mat zwart, Binnenkant goudkleur ·
cromo, vidrio estera negra, Interior en color dorado · cromo, vetro nero opaco, interno colore oro ·
crom, sticla negru mat, interior culoare aurie · kromi, lasi musta matto, sisäosa kullanvärinen ·
chrom, szkło czarny mat, wewnątrz złoty · krom, cam siyah mat, altın iç kaplama



166



Ø 40 cm, ↓ 17,5 cm
excl. 2 x E14, max. 40 W



606100232



Ø 50 cm, ↓ 21 cm
excl. 3 x E27, max. 40 W



606100332





Ø 30 cm
excl. 1 x E14, max. 40 W



506100132



Ø 50 cm
excl. 1 x E27, max. 60 W



506190132



Ø 30 cm, ↓ 150 cm
excl. 1 x E27, max. 40 W



306100132



Ø 50 cm, ↓ 150 cm
excl. 1 x E27, max. 60 W



306190132

FARO

Chrom, Glas Weiß matt, innen goldfarbig · chrome, glass white mat, gold colored inside ·
chrome, verre blanc mat, Or · chrom, glas wit mat, Binnenkant goudkleur ·
cromo, vidrio estera blanca, Interior en color dorado · cromo, vetro bianco opaco, interno colore oro ·
crom, sticla alb mat, interior culoare aurie · kromi, lasi valkoinen matto, sisäosa kullanvärinen ·
chrom, szkło biały mat, wewnątrz złoty · krom, cam beyaz mat, altın iç kaplama



168



Ø 30 cm
excl. 1 x E14, max. 40 W



506100131



Ø 50 cm
excl. 1 x E27, max. 60 W



506190131



Ø 40 cm, ↑ 17,5 cm
excl. 2 x E27, max. 40 W



606100231



Ø 50 cm, ↑ 21 cm
excl. 3 x E27, max. 40 W



606100331



Ø 30 cm, ↑ 150 cm
excl. 1 x E27, max. 40 W



306100131



Ø 50 cm, ↑ 150 cm
excl. 1 x E27, max. 60 W



306190131





↑ 45 cm, ↔ 18 cm, ↗ 19,5 cm
excl. 1 x E27, max. 60 W



210200101
210200102



01 Weiß · white
02 Schwarz · black

MADEIRA

Glas Weiß oder Schwarz, innen goldfarbig · glass white or black, gold colored inside ·
verre blanc ou noir, Or · glas wit of zwart, Binnenkant goudkleur ·
vidrio blanco o negro, Interior en color dorado · vetro bianco o nero, interno colore oro ·
sticla alb sau negru, interior culoare aurie · lasi valkoinen tai musta, sisäosa kullanvärinen ·
szkło biały lub czarny, wewnątrz złoty





89

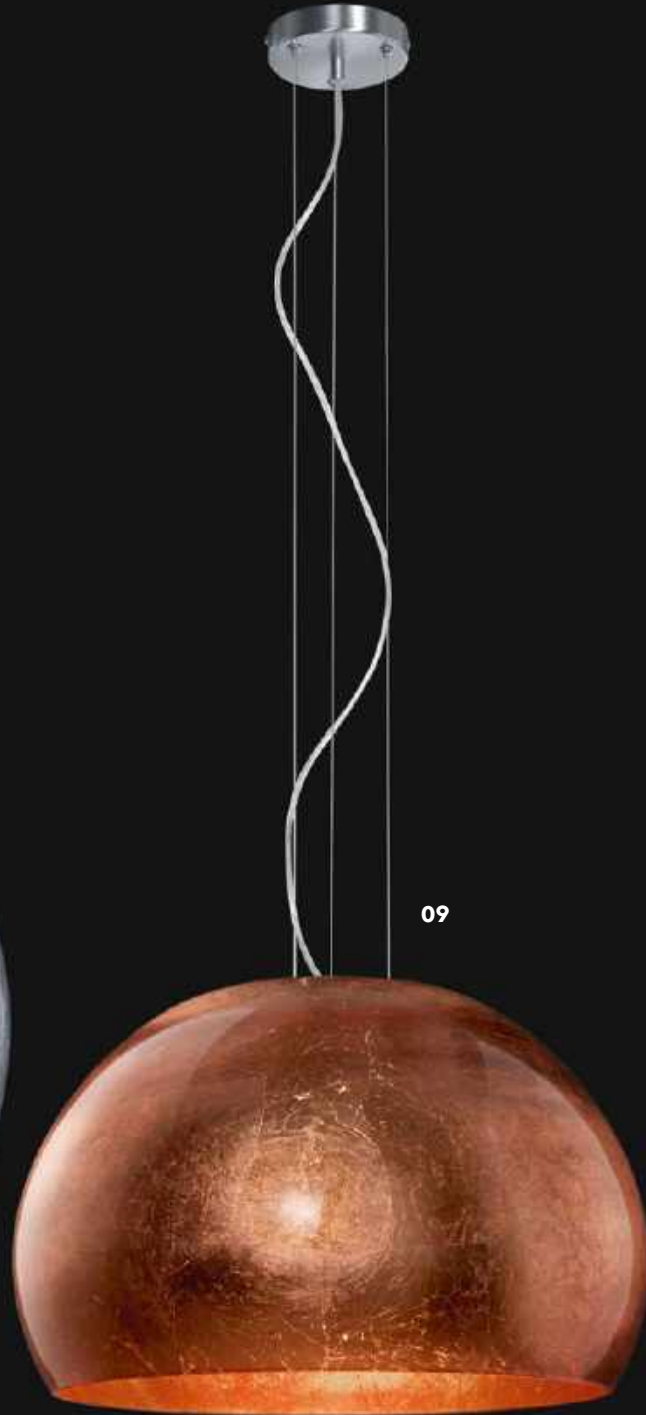

09

ONTARIO

Glas goldfarbig, silberfarbig oder kupferfarbig · glass gold, silver or copper ·
verre or, argent ou cuivré · glas goud, zilver of koperkleurig ·
vidrio oro, plata o color cobre · vetro oro, argento o colore rame ·
sticla aur, argint sau cupru · lasi kultaa, hopea tai kuperinvärinen ·
szkło złota, srebrny lub kolorze miedzi

172



↑ 155 cm, Ø 51 cm
excl. 1 x E27, max. 60 W



315200109
315200179
315200189



09 kupferfarbig · copper
79 goldfarbig · gold
89 silberfarbig · silver

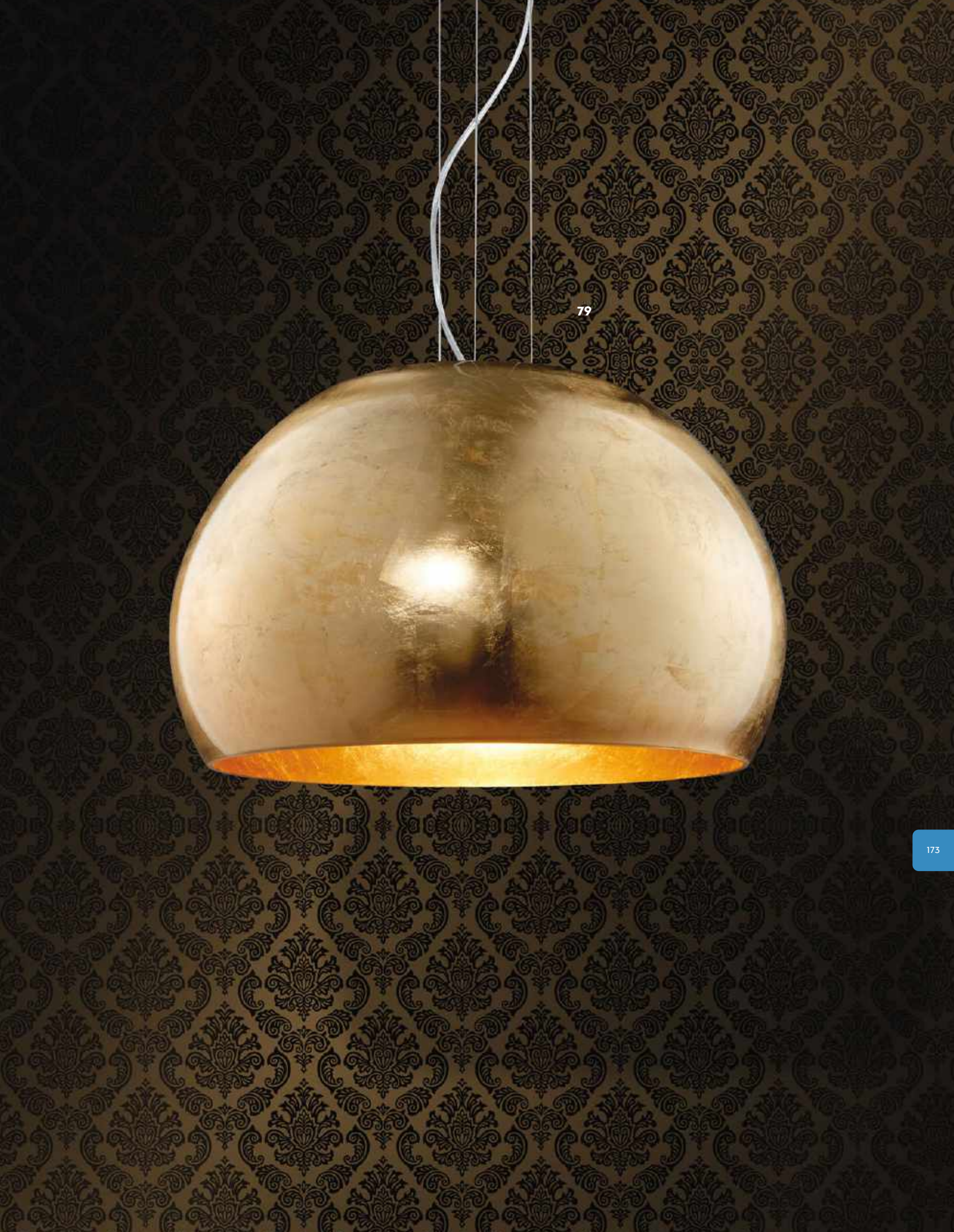



ONTARIO

Glas goldfarbig oder silberfarbig · glass gold or silver ·
 verre or ou argent · glas goud of zilver · vidrio oro o plata ·
 vetro oro o argento · sticla aur sau argint · lasi kultaa tai hopea ·
 szkło złota lub srebrny



↓ 150 cm, Ø 33 cm
 excl. 1 x E27, max. 60 W



305200179
305200189



↓ 150 cm, Ø 18 cm
 excl. 1 x E14, max. 40 W



305290179
305290189



↔ 80 x 18 cm, ↓ 150 cm
 excl. 3 x E14, max. 40 W



305200379
305200389



79 goldfarbig · gold
89 silberfarbig · silver



32



PORTO

Glas, rauchfarbig oder amber · glass, smoke or amber ·
 verre, fumé ou ambre · glas, rookkleur of amber · vidrio, humo o ámbar · vetro, fume' o ambra ·
 sticla, fumuriu sau amber · lasi, savu tai meripihka · szkło, przydymiony lub bursztynowy



Ø 39,5 cm, ↑ 20 cm
 excl. 1 x E14, max. 40 W



508800131
 508800132



Ø 39,5 cm, ↑ 130 cm
 excl. 1 x E27, max. 60 W



308800131
 308800132



Ø 55 cm, ↑ 136 cm
 excl. 1 x E27, max. 60 W



308890131
 308890132



31 weiß matt · white mat
 32 schwarz matt · black mat





KINGSTON

Glas, Chrom · glass, chrome ·
verre, chrome · glas, chrom · vidrio, cromo ·
vetro, cromo · sticla, crom · lasi, kromi ·
szkło, chrom



178



↓ 150 cm, Ø 35 cm
excl. 1 x E27, max. 60 W



315300106



↓ 150 cm, Ø 20 cm
excl. 1 x E14, max. 40 W



315390106



↓ 30,5 cm, Ø 20 cm
excl. 1 x E14, max. 40 W



515300106





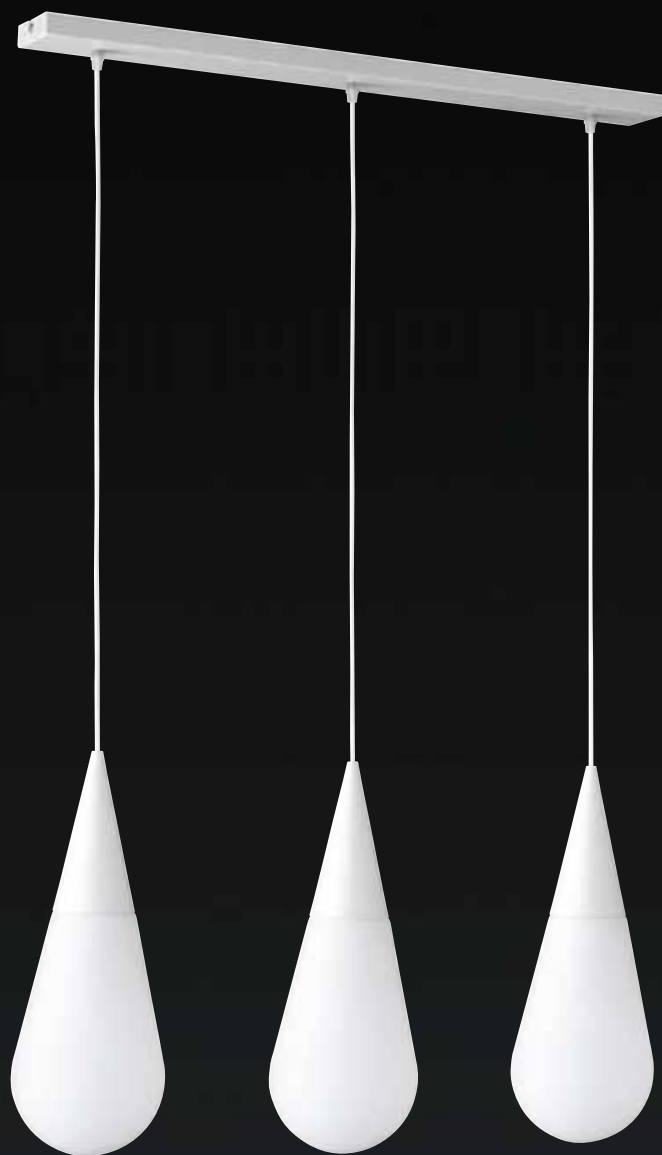

TOULON

Metall, Glas matt · metal, mat glass ·
metale, verre mat · metaal, mat glas · metal, vidrio mate · metallo, vetro sabbato ·
metal, sticla mata · metalli, mattalasi · metal, szkło matowane



↓ 150 cm, Ø 23 cm
excl. 1 x E27, max. 60 W



304790101



↓ 150 cm, Ø 17 cm
excl. 1 x E27, max. 60 W



304700101



↔ 80 x 17 cm, ↓ 120 cm
excl. 3 x E27, max. 60 W



304700301



↔ 13 cm, ↓ 44 cm, ↗ 13 cm
excl. 1 x E27, max. 60 W



204700101





ALICIA

Chrom, Glas rauchfarbig oder Nickel matt, Glas weiß ·
 chrome, glass smoke or nickel mat, glass white ·
 chrome, verre fumé ou nickel mat, verre blanc ·
 chroom, glas rookkleur of nikkel mat, glas wit ·
 cromo, vidrio humo o níquel mate, vidrio blanco ·
 cromo, vetro fume' o nichel opaco, vetro bianco ·
 crom, sticla fumuriu sau nichel mat, sticla alb ·
 kromi, lasi savu tai harjattu teräs, lasi valkoinen ·
 chrom, szkło przydymiony lub nikiel mat, szkło biały

Empfohlen:
 recommended: LED G9, 3 W
 300 lm, 3.000 K



929-2300



Ø 45 cm, ↓ 46,5 cm
 excl. 12 x G9, max. 10 W



607601206
607601207



↓ 150 cm, Ø 45 cm
 excl. 12 x G9, max. 10 W



307601206
307601207



↓ 155 cm, Ø 25 cm
 excl. 9 x G9, max. 5 W



407690906
407690907



06 Chrom · chrome
07 Nickel matt · nickel mat





ALICIA

Chrom, Glas rauchfarbig oder Nickel matt, Glas weiß ·
 chrome, glass smoke or nickel mat, glass white ·
 chrome, verre fumé ou nickel mat, verre blanc ·
 chrom, glas rookkleur of nikkell mat, glas wit ·
 cromo, vidrio humo o níquel mate, vidrio blanco ·
 cromo, vetro fume' o nichel opaco, vetro bianco ·
 crom, sticla fumuriu sau nichel mat, sticla alb ·
 kromi, lasi savu tai harjattu teräs, lasi valkoinen ·
 chrom, szkło przydymiony lub nikiel mat, szkło biały

Empfohlen:

recommended: LED G9, 3 W
 300 lm, 3.000 K



929-2300



↔ 100 x 24,5 cm, ↓ 22,5 cm
 excl. 10 x G9, max. 10 W



607601006
607601007



↓ 150 cm, ↔ 100 x 24,5 cm
 excl. 10 x G9, max. 10 W



307601006
307601007



↓ 52 cm, Ø 23 cm
 excl. 6 x G9, max. 5 W



507690606
507690607



06 Chrom · chrome
07 Nickel matt · nickel mat







BALINI

Metall, Glas klar oder Rauchglas · metal, clear glass or smoked glass ·
 metale, verre claire ou verre fumé · metaal, helder glas of rookglas · metal, vidrio claro o vidrio ahumado ·
 metallo, vetro chiaro o vetro fume' · metal, sticlă transparentă sau sticla fumurie ·
 metalli, kirkas lasi tai savulasi · metal, przezroczyste szkło lub szkło przydymione

Empfohlen:
 recommended: Filament LED E14, 4 W
 470 lm, 3.000 K



983-400



Ø 30 cm, ↓ 150 cm
 excl. 3 x E14, max. 28 W



308590331
308590342



↔ 100 x 16 cm, ↓ 150 cm
 excl. 5 x E14, max. 28 W



308500531
308500542



↓ 180 cm, ↔ 30 cm, ↗ 85 cm
 excl. 5 x E14, max. 28 W



408500531
408500542



31 Weiß matt · white mat
42 Anthrazit · anthracite



VALENTE

Metall, Weiß matt / Glas klar oder Anthrazit / Rauchglas ·
 metal, white mat / clear glass or anthracite / smoked glass ·
 Metale, blanc mat / verre claire ou anthracite / verre fumé ·
 metaal, wit mat / helder glas of antraciet / rookglas ·
 metal, estera blanca / vidrio claro o antracita / vidrio ahumado ·
 metallo, bianco opaco / vetro chiaro o anthracite / vetro fumé ·
 metal, alb mat / sticlă transparentă sau antracit / sticlă fumurie ·
 metalli, mattavalkoinen / kirkas lasi tai antrasiitti / savulasi ·
 metal, biały mat / przezroczyste szkło lub antracyt / szkło przydymione

Empfohlen:
 recommended: Filament LED E27, 4 W
 470 lm, 3.000 K



987-400



Ø 40 cm, ↑ 25 cm
 excl. 3 x E27, max. 60 W



600600331
 600600342



Ø 40 cm, ↑ 150 cm
 excl. 3 x E27, max. 60 W



300600331
 300600342



31 Weiß matt · white mat
 42 Anthrazit · anthracite



07



MIDAS

Glas matt Weiß oder Rauchglas · mat glass white or smoked glass · verre mat blanc ou verre fumé · mat glas wit of rookglas · vidrio mate blanco o vidrio ahumado · vetro sabbiato bianco o vetro fume' · sticla mata alb sau sticla fumurie · mattalasi valkoinen tai savulasi · szkło matowane biały lub szkło przydymione



190



Ø 30 cm
excl. 1 x E27, max. 60 W



501600106
501600107



Ø 30 cm, ↑ 150 cm
excl. 1 x E27, max. 60 W



301600106
301600107



Ø 45 cm, ↑ 150 cm
excl. 1 x E27, max. 60 W



301690106
301690107



06 Chrom · chrome
07 Nickel matt · nickel mat





ROBIN

Metall Schwarz matt, Glas rauchfarbig · metal black mat, glass smoke ·
 metale noir mat, verre fumé · metaal mat zwart, glas rookkleur ·
 metal estera negra, vidrio humo · metallo nero opaco, vetro fume' ·
 metal negru mat, sticla fumuriu · metalli mattamusta, lasi savu ·
 metal czarny mat, szkło przydymiony



↓ 150 cm, Ø 10 cm
 excl. 1 x E27, max. 28 W



310600132



↓ 150 cm, Ø 37 cm
 excl. 3 x E27, max. 28 W



310630332



↓ 150 cm, ↔ 80,5 cm
 excl. 4 x E27, max. 28 W



310600432



↓ 25,5 cm, Ø 11 cm
 excl. 1 x E27, max. 28 W



510600132





Seite/page 685

PURE

Messing matt, Glas Weiß oder Anthrazit, Glas rauchfarbig · brass mat, glass white or anthracite, glass smoke · laiton mat, verre blanc ou antracite, verre fumé · messing mat, glas wit of antraciet, glas rookkleur · bronze mate, vidrio blanco o antracita, vidrio humo · ottone satinato, vetro bianco o antracite, vetro fume' · bronz mat, sticla alb sau antracit, sticla fumuriu · mattamessinki, lasi valkoinen tai antrasiitti, lasi savu · mosiądz mat, szkło biały lub antracyt, szkło przydymiony



↓ 21 x 18 cm, ↗ 21 cm
excl. 1 x E14, max. 28 W



202000108
202000142



↓ 150 cm, Ø 40 cm
excl. 3 x E14, max. 28 W



302000308
302000342



↓ 52 cm, ↔ 18 cm, ↗ 24 cm
excl. 1 x E14, max. 28 W



502000108
502000142



↓ 150 cm, ↔ 25 cm, ↗ 32 cm
excl. 1 x E14, max. 28 W



402000108
402000142



08 Messing matt · brass mat
42 Anthazit · anthracite



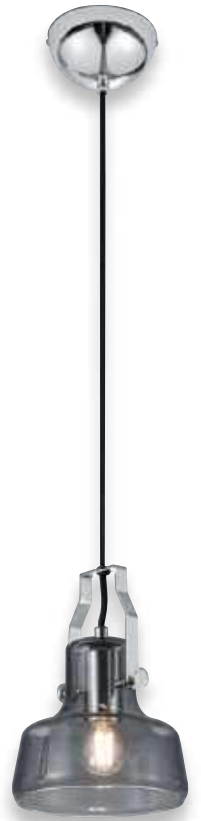

KOLANI

Chrom, Rauchglas · chrome, smoked glass ·
 chrome, verre fumé · chrom, rookglas · cromo, vidrio ahumado ·
 cromo, vetro fume' · crom, sticla fumurie · kromi, savulasi ·
 chrom, szkło przydymione

Empfohlen:
 recommended: Filament LED E14, 4 W
 470 lm, 3.000 K



983-400



↓ 10 x 10 cm, ↗ 25 cm
 excl. 1 x E14, max. 28 W



805600106



↔ 27,5 x 7 cm, ↓ 25 cm
 excl. 2 x E14, max. 28 W



805600206



↔ 45,5 x 7 cm, ↓ 25 cm
 excl. 3 x E14, max. 28 W



805600306



↔ 83 x 10 cm, ↓ 27,5 cm
 excl. 4 x E14, max. 28 W



805600406



↔ 85 x 47,5 cm, ↓ 24 cm
 excl. 5 x E14, max. 28 W



605600506



↓ 150 cm, Ø 16 cm
excl. 1 x E14, max. 28 W



305600106



↔ 95 x 12 cm, ↓ 150 cm
excl. 4 x E14, max. 28 W

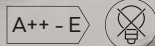

305600406



GINELLI

Nickel matt, Glas matt · nickel mat, mat glass ·
 nickel mat, verre mat · nikkel mat, mat glas ·
 níquel mate, vidrio mate · nichel opaco, vetro sabbato ·
 nichel mat, sticla mata · harjattu teräs, mattalasi ·
 nikiel mat, szkło matowane



↓ 20 x 14 cm, ↗ 20 cm
 excl. 1 x E14, max. 28 W



801500107



↔ 44 x 12 cm, ↓ 22 cm
 excl. 2 x E14, max. 28 W



801500207



↔ 60 x 12 cm, ↓ 22 cm
 excl. 3 x E14, max. 28 W



801500307



↔ 80 x 12 cm, ↓ 22 cm
 excl. 4 x E14, max. 28 W



801500407



↔ 90 x 48 cm, ↓ 24 cm
 excl. 5 x E14, max. 28 W



601500507



↔ 70 x 12 cm, ↓ 150 cm
excl. 4 x E14, max. 28 W



301500407

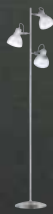

↓ 150 cm, ↔ 37 cm
excl. 3 x E14, max. 28 W



401500307



SIGNA

Chrom, Dekorglas Weiß · chrome, glas decorated white ·
chrome, verre décoré blanc · chroom, decoratief glas wit ·
cromo, vidrio decorado blanco · cromo, vetro decorato bianco ·
chrom, sticla decorativa alb · kromi, ornamenttilasi valkoinen ·
chrom, szkło dekoracyjne biały

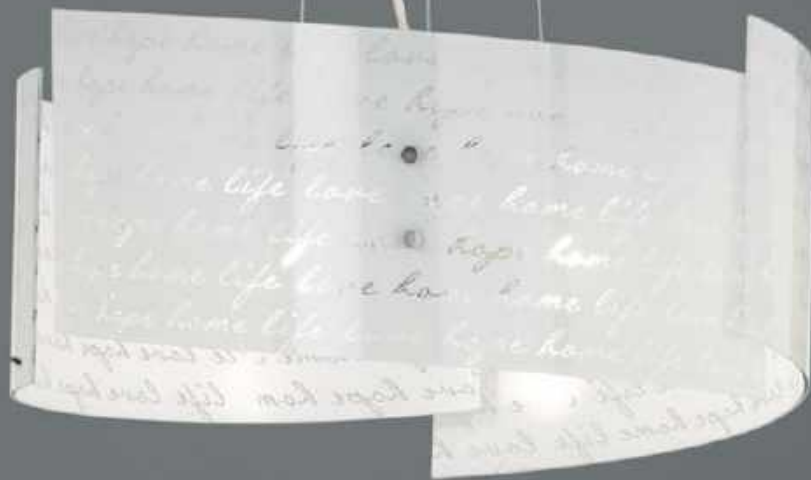

↔ 20 x 30 cm, ↗ 9 cm
excl. 1 x E27, max. 40 W



202500101



↔ 30 x 30 cm, ↓ 9 cm
excl. 1 x E27, max. 40 W



602500101



↔ 40 x 40 cm, ↓ 9,5 cm
excl. 2 x E27, max. 40 W



602500201



↔ 50 x 50 cm, ↓ 11 cm
excl. 3 x E27, max. 40 W



602500301



Ø 50 cm, ↓ 150 cm
excl. 3 x E27, max. 40 W



302500301

SPIRELLI

Chrom, Dekorglas Weiß · chrome, glas decorated white ·
chrome, verre décoré blanc · chrom, decoratief glas wit ·
cromo, vidrio decorado blanco · cromo, vetro decorato bianco ·
crom, sticla decorativa alb · kromi, ornamenttilasi valkoinen ·
chrom, szkło dekoracyjne biały



↔ 30 x 22 cm, ↗ 7,5 cm
excl. 1 x E27, max. 40 W



204400101



↔ 30 x 30 cm, ↑ 9 cm
excl. 1 x E27, max. 40 W



604400101



↔ 40 x 40 cm, ↑ 9,5 cm
excl. 2 x E27, max. 40 W



604400201



↔ 50 x 50 cm, ↑ 11 cm
excl. 3 x E27, max. 40 W



604400301



↔ 40 x 20 cm, ↑ 150 cm
excl. 2 x E27, max. 40 W



304400201

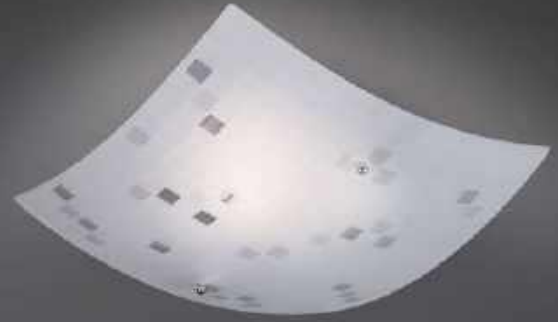

COLINA

Dekorglas · glas decorated ·
verre décoré · decoratief glas · vidrio decorado ·
vetro decorato · sticla decorativa · ornamenttilasi ·
szkło dekoracyjne



↔ 17 cm, ↑ 23 cm, ↗ 8,5 cm
excl. 1 x E27, max. 40 W



200400100



↔ 30 x 30 cm, ↑ 9 cm
excl. 1 x E27, max. 40 W



600400100



↔ 40 x 40 cm, ↑ 10 cm
excl. 2 x E27, max. 40 W



600400200



↔ 50 x 50 cm, ↑ 11 cm
excl. 3 x E27, max. 40 W



600400300



↔ 50 x 20 cm, ↑ 150 cm
excl. 2 x E27, max. 40 W



300400200



SANDRINA

Dekorglas · glas decorated ·
verre décoré · decoratief glas · vidrio decorado ·
vetro decorato · sticla decorativa · ornamenttilasi ·
szkło dekoracyjne



203



↔ 30 x 15 cm, ↗ 8 cm
excl. 1 x E27, max. 40 W



201200100



Ø 30 cm, ↑ 9 cm
excl. 1 x E27, max. 40 W



601200100



Ø 40 cm, ↑ 10 cm
excl. 2 x E27, max. 40 W



601200200



Ø 50 cm, ↑ 13 cm
excl. 3 x E27, max. 40 W



601200300



Ø 50 cm, ↑ 150 cm
excl. 3 x E27, max. 40 W



301200300



↔ 30 x 15 cm, ↗ 9 cm
excl. 1 x E27, max. 40 W



207700100



∅ 30 cm, ↑ 9 cm
excl. 1 x E27, max. 40 W



607700100



∅ 40 cm, ↑ 10 cm
excl. 2 x E27, max. 40 W



607700200



∅ 50 cm, ↑ 13 cm
excl. 3 x E27, max. 40 W



607700300



∅ 50 cm, ↑ 150 cm
excl. 3 x E27, max. 40 W



307700300



CHRISTOBAL

Chrom, Dekorglas Weiß · chrome, glas decorated white ·
chrome, verre décoré blanc · chroom, decoratief glas wit · cromo, vidrio decorado blanco ·
cromo, vetro decorato bianco · crom, sticla decorativa alb · kromi, ornamenttilasi valkoinen ·
chrom, szkło dekoracyjne biały



79



89



NIKOSIA

Dekorglas · glas decorated · verre décoré · decoratief glas · vidrio decorado · vetro decorato · sticla decorativa · ornamenttilasi · szkło dekoracyjne



↔ 30 x 22 cm, ↑ 7,5 cm
excl. 1 x E27, max. 40 W

↔ 30 x 30 cm, ↑ 9 cm
excl. 1 x E27, max. 40 W

↔ 40 x 40 cm, ↑ 9,5 cm
excl. 2 x E27, max. 40 W

↔ 50 x 50 cm, ↑ 11 cm
excl. 3 x E27, max. 40 W

↔ 50 x 20 cm, ↑ 150 cm
excl. 2 x E27, max. 40 W



208700179
208700189

608700179
608700189

608700279
608700289

608700379
608700389

308700279
308700289



Ø 14 cm, ↓ 150 cm
excl. 1 x E27, max. 40 W



308700179
308700189



↔ 80 cm, ↓ 150 cm
excl. 3 x E27, max. 40 W



308700379
308700389



79 goldfarbig · gold
89 silberfarbig · silver



SWEETY

Acryl · acryl ·
acryl · acryl · acrílico · acrílico ·
acrilic · akryyli · akryl



Ø 30 cm, ↓ 150 cm
excl. 1 x E27, max. 60 W



307800100



Ø 40 cm, ↓ 150 cm
excl. 1 x E27, max. 60 W



307804100



↔ 20 x 20 cm, ↗ 9 cm
excl. 1 x E14, max. 40 W



207800100



Ø 30 cm, ↓ 10,5 cm
excl. 1 x E27, max. 60 W



607800100



CAPITAL

Metall, Chrom · metal, chrome ·
metale, chrome · metaal, chroom · metal, cromo ·
metallo, cromo · metal, crom · metalli, kromi ·
metal, chrom



↔ 22 cm, ↓ 17 cm, ↗ 11 cm
excl. 1 x E14, max. 40 W



208400106



↓ 130 cm, Ø 40 cm
excl. 2 x E14, max. 40 W



308400206



↓ 40 cm, Ø 12 cm
excl. 1 x E14, max. 40 W

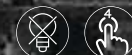

598400106



CONNOR

Metall, Weiß matt oder Schwarz matt · metal, white mat or black mat ·
 metale, blanc mat ou noir mat · metaal, wit mat of mat zwart ·
 metal, estera blanca o estera negra · metallo, bianco opaco o nero opaco ·
 metal, alb mat sau negru mat · metalli, valkoinen matto tai musta matto ·
 metal, biały mat lub czarny mat

Empfohlen:
 recommended: Filament LED E27, 6 W
 190 lm, 3.000 K



988-654

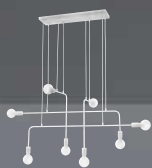

↔ 126 x 40 cm, ↑ 150 cm
 excl. 8 x E27, max. 28 W



306200831
 306200832



↑ 138 cm, ↔ 43 cm
 excl. 5 x E27, max. 28 W



406200532



31 Weiß matt · white mat
 32 Schwarz matt · black mat





DISCUS

Metall, Weiß matt oder Schwarz matt · metal, white mat or black mat ·
metale, blanc mat ou noir mat · metaal, wit mat of mat zwart ·
metal, estera blanca o estera negra · metallo, bianco opaco o nero opaco ·
metal, alb mat sau negru mat · metalli, valkoinen matto tai musta matto ·
metal, biały mat lub czarny mat

Empfohlen:

recommended: Filament LED E27, 6 W
190 lm, 3.000 K



988-654

212



↔ 53,5 x 20,5 cm, ↑ 6 cm
excl. 4 x E27, max. 28 W



610400431
610400432



↔ 92,5 x 21 cm, ↑ 150 cm
excl. 6 x E27, max. 28 W



310400631
310400632



31 Weiß matt · white mat
32 Schwarz matt · black mat







Seite/page 685

DIALLO

Metall, Weiß matt oder Schwarz matt · metal, white mat or black mat ·
 metale, blanc mat ou noir mat · metaal, wit mat of mat zwart ·
 metal, estera blanca o estera negra · metallo, bianco opaco o nero opaco ·
 metal, alb mat sau negru mat · metalli, valkoinen matto tai musta matto ·
 metal, biały mat lub czarny mat

Empfohlen:
 recommended: Filament LED E27, 6 W
 420 lm, 2.700 K



988-679



↑ 15 x 10 cm, ↗ 20 cm
 excl. 1 x E27, max. 42 W



208070131
 208070132



Ø 47 cm, ↑ 16,5 cm
 excl. 3 x E27, max. 42 W



608000331
 608000332



↑ 51 cm, ↗ 23,5 cm
 excl. 1 x E27, max. 42 W



508000131
 508000132



↑ 149 cm, ↗ 39 cm
 excl. 1 x E27, max. 42 W



408000131
 408000132



31 Weiß matt · white mat
 32 Schwarz matt · black mat

Empfohlen:
recommended: Filament LED E27, 6 W
600 lm, 3.000 K



988-654





CROSS

Metall, Schwarz matt / goldfarbig · metal, black mat / gold ·
 metale, noir mat / or · metaal, mat zwart / goud ·
 metal, estera negra / oro · metallo, nero opaco / oro ·
 metal, negru mat / aur · metalli, musta matto / kultaa ·
 metal, czarny mat / złota

Empfohlen:

recommended: LED E27, 6 W
 420 lm, 2.700 K



988-679



Ø 57 cm, ↓ 19 cm
 excl. 6 x E27, max. 40 W



606700632



↔ 91 x 45 cm, ↓ 150 cm
 excl. 7 x E27, max. 28 W



306700732



Ø 54,5 cm, ↓ 150 cm
 excl. 6 x E27, max. 28 W



306700632



↓ 165 cm, Ø 55 cm
 excl. 6 x E27, max. 28 W



406700632







NACHO

Metall Schwarz matt/bronzefarbig, Glas klar · metal black mat/bronze, clear glass · metale noir mat/bronze, verre claire · metaal mat zwart/bronze, helder glas · metal estera negra/bronze, vidrio claro · metallo nero opaco/bronzo, vetro chiaro · metal negru mat/bronz, sticlă transparentă · metalli musta matto/pronssi, kirkas lasi · metal czarny mat/brąz, przezroczyste szkło

218



↓ 38,5 x 12 cm, ↗ 16 cm
excl. 1 x E14, max. 28 W



200800132



∅ 57 cm, ↓ 45 cm
excl. 5 x E14, max. 28 W



600800532



∅ 61 cm, ↓ 150 cm
excl. 6 x E14, max. 28 W



100800632



∅ 12 cm, ↓ 150 cm
excl. 1 x E14, max. 28 W



300800132



↔ 90 x 12 cm, ↓ 150 cm
excl. 4 x E14, max. 28 W



300800432

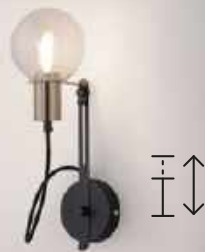



ORCHESTRA

Metall, Weiß matt / goldfarbig oder Schwarz matt / goldfarbig · metal, white mat / gold or black mat / gold ·
 metals, blanc mat / or ou noir mat / or · metaal, wit mat / goud of mat zwart / goud ·
 metal, estera blanca / oro o estera negra / oro · metallo, bianco opaco / oro o nero opaco / oro ·
 metal, alb mat / aur sau negru mat / aur · metalli, mattavalkoinen / kultaa tai mattamusta / kultaa ·
 metal, biały mat / złota lub czarny mat / złota

220



Ø 48 cm, ↑ 150 cm
 excl. 15 x E14, max. 28 W



303201531
303201532



Ø 50 cm, ↑ 26 cm
 excl. 10 x E14, max. 28 W



603201031
603201032



31 Weiß matt · white mat
32 Schwarz matt · black mat





DISCALGO

Metall, Kunststoff · metal, plastic ·
metale, plastique · metaal, kunststof ·
metal, plástico · metallo, plastica ·
metal, plastic · metalli, muovi ·
metal, plastik

222



Ø 54 cm, ↑ 30 cm
excl. 3 x E14, max. 40 W



609900331
609900332



Ø 54 cm, ↑ 150 cm
excl. 6 x E14, max. 40 W



309900631
309900632



31 Weiß matt · white mat
32 Schwarz matt · black mat





EDWARD

Metall, Schwarz matt · metal, black mat ·
 metale, noir mat · metaal, mat zwart · metal, estera negra ·
 metallo, nero opaco · metal, negru mat ·
 metalli, mattamusta · metal, czarny mat

Empfohlen:
 recommended: Filament LED E14, max. 4 W
 470 lm, 2.700 K



983-4470



Ø 12 cm, ↗ 50 cm
 excl. 1 x E14, max. 28 W



208870132



Ø 80 cm, ↓ 26 cm
 excl. 6 x E14, max. 28 W



608800632



Ø 80 cm, ↓ 150 cm
 excl. 6 x E14, max. 28 W



118800632



↓ 160 cm, ↔ 38 cm
 excl. 3 x E14, max. 28 W



408800332

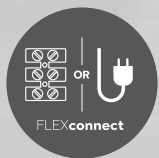

Seite/page 685





07



04



09

JASPER

Metall · metal ·
metale · metaal · metal · metallo ·
metal · metalli · metal · metal



Ø 31 cm, ↓ 150 cm
excl. 1 x E27, max. 60 W



300500104
300500107
300500109



↓ 45 cm, ↗ 23 cm
excl. 1 x E14, max. 40 W



500500104
500500107
500500109



↓ 140 cm, ↗ 52 cm
excl. 1 x E14, max. 40 W



400500104
400500107
400500109



04 Altmessing · old brass
07 Nickel matt · matt nickel
09 kupferfarbig · copper

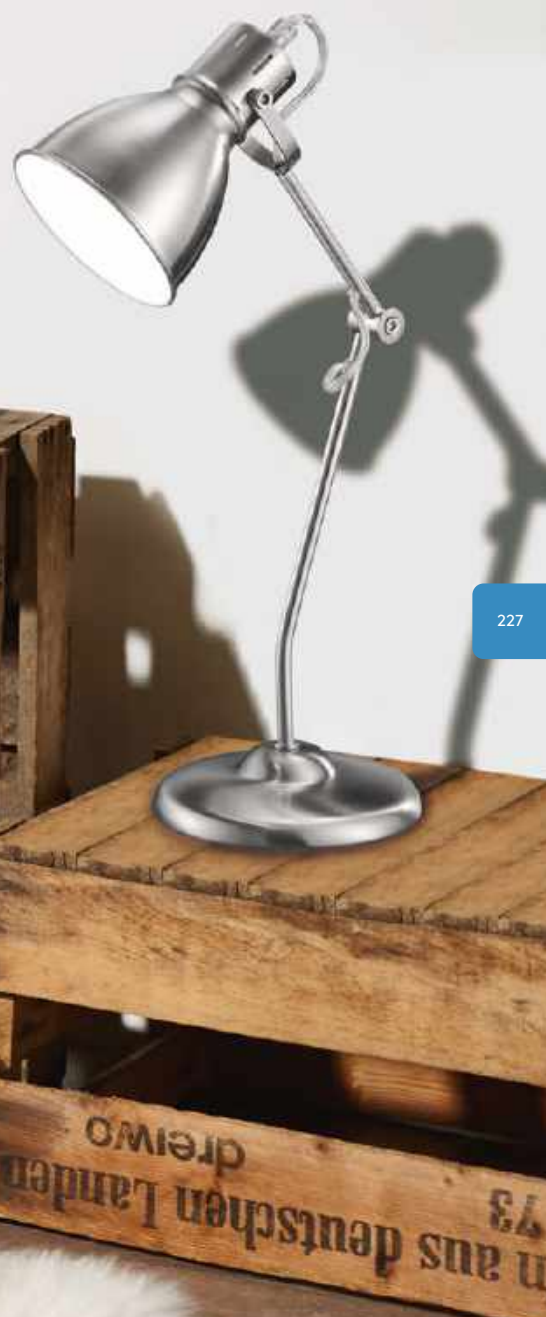

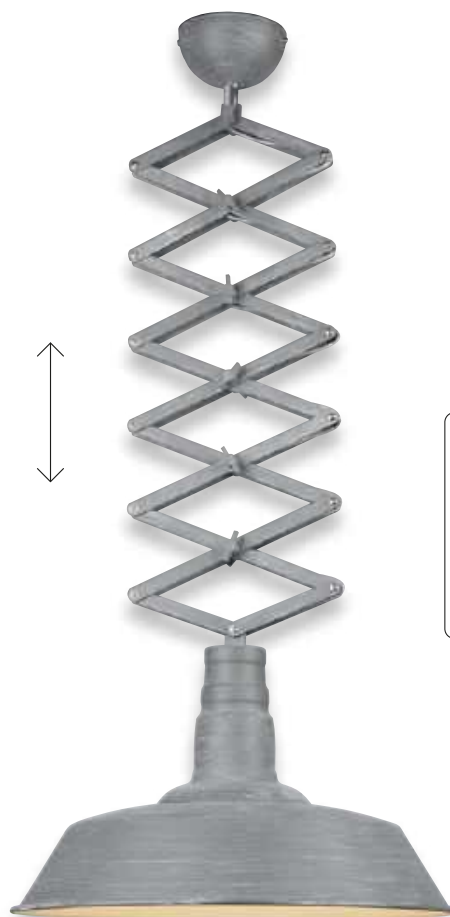

DETROIT

Metall, rostfarbig oder betonfarbig · metal, rusty or concrete look ·
 metale, rouille ou couleur beton · metaal, roestkleur of beton kleur ·
 metal, óxido o color concreto · metallo, ruggine o calcestruzzo ·
 metal, ruginiu sau culoare beton · metalli, rustiikki tai konkreettisia väri ·
 metal, miedź lub konkretny kolor



↓ 34 cm, Ø 36 cm, ↗ 35 - 53 cm
 excl. 1 x E27, max. 42 W



205300124
 205300178



↓ 50 - 150 cm, Ø 46 cm
 excl. 1 x E27, max. 42 W



305300124
 305300178



↔ 97 - 187 cm, ↓ 150 cm, Ø 36 cm
 excl. 2 x E27, max. 42 W



305300224
 305300278



24 rostfarbig · rusty
 78 betonfarbig · concrete look



97 - 187 cm



NAPOLI

Metall, rostfarbig antik mit Acrylapplikationen · metal, antique rust with acrylic decoration ·
 métal, rouille antique avec décoration acrylique · Metaal, roestkleur antiek met acryl decoraties ·
 Metal, oxido con decoración en acrílico · metallo, ruggine anticato con decorazione in acrilico ·
 metal, ruginiu antic cu decoratie acrilica · metaalia, rustiikki jossa akryyli koristeet ·
 Metal, antyczny rdzawy z aplikacjami akrylowym

Empfohlen:
 recommended: Filament LED E14, 4 W
 470 lm, 3.000 K



989-400



↔ 40 x 36,5 cm, ↗ 21 cm
 excl. 2 x E14, max. 28 W



210370228



Ø 50 cm, ↑ 50 cm
 excl. 4 x E14, max. 28 W



610300428



Ø 52 cm, ↑ 150 cm
 excl. 4 x E14, max. 28 W



110300428





TRADITIO

Metall, Glas alabasterfarbig · metal, alabaster-coloured glass ·
 metale, verre couleur albâtre · metaal, albastkleurig glas · metal, vidrio de color alabastro ·
 metallo, vetro colore alabastro · metal, sticla culoare alabastru · metalli, lasi alabasteri väri ·
 metal, szkło alabaster kolor

232



↔ 21,5 x 13 cm, ↗ 29 cm
 excl. 1 x E14, max. 40 W



200700128
200700161



↓ 32 cm, ↗ 27 cm
 excl. 1 x E14, max. 40 W



500700128
500700161



Ø 70 cm, ↓ 150 cm
 excl. 3 x E14, max. 40 W



110700328
110700361



Ø 70 cm, ↓ 150 cm
 excl. 5 x E14, max. 40 W



110700528
110700561



Ø 61 cm, ↓ 26 cm
 excl. 3 x E14, max. 40 W



600700328
600700361



28 rostfarbig antik · antique rust

61 Grau antik · antique grey



Leuchten im Vintage Stil

Vintage style luminaires

Luminaire style Vintage

Armaturen in Vintage stijl

Lámparas vintage

Apparecchi stile vintage

Corpuri de iluminat vintage

Vintage valaisimet

Lampy w stylu vintage



BRAD

Nickel antik, Holz · nickel antique, wood ·
 nickel antique, bois · antiek nikkell, hout · níquel antiguo, madera ·
 nickell anticato, di legno · nichel antic, lemn · antiikkiteräs, puu ·
 aikiel antyczny, drewno · antik nikel, tahta

LED SWITCHDIMMER



↑ 11 x 11 cm, ↗ 11 cm
 incl. OSRAM-LED, 4,3 W
 430 lm, 3.000 K



223710130

↑ 11 x 37 cm, ↗ 11 cm
 incl. SMD-LED, 13,5 W
 1.800 lm, 3.000 K



223790130

↔ 100 x 20 cm, ↓ 16,7 cm
 incl. SMD-LED, 27 W
 3.000 lm, 3.000 K



623710130

↔ 100 x 20 cm, ↓ 150 cm
 incl. SMD-LED, 27 W
 3.000 lm, 3.000 K



323710130



VINTAGE



KHAN

Nickel antik, Holz · nickel antique, wood ·
 nickel antique, bois · antiek nikkell, hout · níquel antiguo, madera ·
 nickel anticato, di legno · nichel antic, lemn · antiikkiteräs, puu ·
 aikiel antyczny, drewno · antik nikel, tahta

Empfohlen:
 recommended: Filament LED E27, 6 W
 420 lm, 2.700 K



987-679

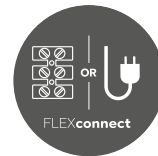

Seite/page 685



↔ 100 x 15 cm, ↓ 150 cm
 excl. 4 x E27, max. 28 W



305500467

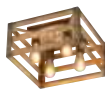

↔ 40 x 40 cm, ↓ 20 cm
 excl. 4 x E27, max. 28 W



605500467



↓ 20 cm, ↔ 15 cm, ↗ 11 cm
 excl. 1 x E27, max. 28 W



205570167



↓ 20 cm, ↔ 35 cm, ↗ 11 cm
 excl. 2 x E27, max. 28 W



205570267



↓ 153 cm, ↔ 25 x 25 cm
 excl. 3 x E27, max. 28 W



405500367





IVAR

Metall, Nickel antik, Holz · metal, nickel antique, wood ·
 metale, nickel antique, bois · metaal, antiek nikkel, hout ·
 metal, níquel antiguo, madera · metallo, nickel anticato, di legno ·
 metal, nichel antic, lemn · metalli, antiikkiteräs, puu ·
 metal, aikiel antyczny, drewno



Empfohlen:
 recommended: Filament LED E27, 8 W
 560 lm, 2.700 K



907-879



Ø 25 cm, ↓ 150 cm
 excl. 1 x E27, max. 40 W



309000167



Ø 40 cm, ↓ 150 cm
 excl. 1 x E27, max. 40 W



309090167



↔ 125 x 3 cm, ↓ 150 cm, Ø 40 cm
 excl. 2 x E27, max. 40 W



309000267



↓ 150 - 186 cm, Ø 69 cm
 excl. 1 x E27, max. 40 W



409000167





DELHI

Metall, Nickel antik, Holz · metal, nickel antique, wood ·
 metale, nickel antique, bois · metaal, antiek nikkel, hout · metal, níquel antiguo, madera ·
 metallo, nickel anticato, di legno · metal, nichel antic, lemn · metalli, antiikkiteräs, puu ·
 metal, aikiel antyczny, drewno

242



Ø 45 cm, ↓ 150 cm
 excl. 1 x E27, max. 60 W



303400167



↔ 107,5 cm, ↓ max. 215 cm, Ø 25,5 cm
 excl. 3 x E27, max. 42 W



303400367



↓ 150 cm, Ø 25,5 cm, ↗ 21,5 cm
 excl. 1 x E27, max. 42 W



403490167





DELHI

Metall, Nickel antik, Holz · metal, nickel antique, wood ·
 metale, nickel antique, bois · metaal, antiek nikkel, hout ·
 metal, níquel antiguo, madera · metallo, nickel anticato, di legno ·
 metal, nichel antic, lemn · metalli, antiikkiteräs, puu ·
 metal, aikiel antyczny, drewno



Ø 11,6 cm, √ 20,5 cm
 excl. 1 x E14, max. 40 W



803400167



↔ 33 x 8,5 cm, ↓ 20,5 cm
 excl. 2 x E14, max. 40 W



803400267



↔ 58 x 8,5 cm, ↓ 20,5 cm
 excl. 3 x E14, max. 40 W



803400367



↓ 158 cm, ↔ 66 cm, Ø 40 cm
 excl. 1 x E27, max. 60 W



403400167





MADRAS

silberfarbig antik, Holz · antique silver, wood ·
 argent antique, bois · antiek zilver, hout · plateado antiguo, madera · argento anticato, di legno ·
 argint antic, lemn · antiikkihopea, puu · antyczne srebro, drewno · gümüş antika, tahta

Empfohlen:
 recommended: Filament LED E27, 8 W
 806 lm, 2.700 K



987-6810



↓ 23 cm, ↗ 14 x 17 cm
 excl. 1 x E27, max. 28 W



805300188



↔ 30 x 14 cm, ↓ 28 cm
 excl. 2 x E27, max. 28 W



805300288



↔ 60 x 14 cm, ↓ 28 cm
 excl. 3 x E27, max. 28 W



805300388



↔ 80 x 14 cm, ↓ 28 cm
 excl. 4 x E27, max. 28 W



805300488



↔ 90 x 14 cm, ↓ 150 cm
 excl. 4 x E27, max. 28 W



305300488





TIMBER

Nickel matt, Holz · nickel mat, wood · nickel mat, bois ·
 nikkell mat, hout · níquel mate, madera · nichel opaco, di legno ·
 nichel mat, lemn · harjattu teräs, puu · nikiel mat, drewno



↔ 12,5 x 15 cm, ↗ 21,5 cm
 excl. 1 x E14, max. 40 W



805000130



↔ 35 x 12,5 cm, ↓ 25 cm
 excl. 2 x E14, max. 40 W



805000230



↔ 65 x 12,5 cm, ↓ 25 cm
 excl. 3 x E14, max. 40 W



805000330



↔ 90 x 12,5 cm, ↓ 25 cm
 excl. 4 x E14, max. 40 W



805000430



↔ 85 x 12,5 cm, ↓ 150 cm
 excl. 4 x E14, max. 40 W



305000430



PLANT

Nickel antik, Sisal · nickel antique, Sisal ·
 nickel antique, Sisal · antiek nikkell, Sisal ·
 níquel antiguo, Sisal · nickel anticato, Sisal ·
 nichel antic, Sisal · antiikkiteräs, Sisal ·
 aikiel antyczny, Sisal

Deko-Pflanze nicht enthalten! · Decoration not included! ·
 Décoration non incluse ! · Decoratie niet inbegrepen! ·
 Decoración no incluida. · Decorazione non inclusa! ·
 Decorația nu este inclusă! · Koristus ei sisälly! ·
 Nie zawiera dekoracji!

Empfohlen:
 recommended: Filament LED E27, 4 W
 470 lm, 3.000 K



987-400



Ø 22 cm, ↑ 150 cm
 excl. 1 x E27, max. 28 W



301000167



↔ 115 x 22 cm, ↑ 150 cm
 excl. 3 x E27, max. 28 W



301000367



92945



JANKO

Holz, Stoffschirm · wood, fabric shade ·
 bois, abat-jour tissu · hout, Stoffen kap ·
 madera, Pantalla de tela · di legno, paralume in tessuto ·
 lemn, abajur textil · puu, kangas varjostin ·
 drewno, Klosz z materiału



↓ 44 cm, ↗ 26 cm
 excl. 1 x E14, max. 40 W



507700114



↓ 160 cm, ↗ 40 cm
 excl. 1 x E14, max. 40 W



407700114





253

FORESTER

Metall, Nickel antik, Holz · metal, nickel antique, wood ·
metale, nickel antique, bois · metaal, antiek nikkel, hout · metal, níquel antiguo, madera ·
metallo, nickel anticato, di legno · metal, nichel antic, lemn · metalli, antiikkiteräs, puu ·
metal, aikiel antyczny, drewno



↔ 100 x 10 cm, ↑ 200 cm
excl. 5 x E27, max. 42 W



308100567



TOSH

Metall, Schwarz matt, Holz · metal, black mat, wood ·
 metale, noir mat, bois · metaal, mat zwart, hout · metal, estera negra, madera ·
 metallo, nero opaco, di legno · metal, negru mat, lemn · metalli, mattamusta, puu ·
 metal, czarny mat, drewno

Empfohlen:

recommended: Filament LED E27, 8 W
 806 lm, 3.000 K



987-6810



Ø 10 cm, ↓ 150 cm
 excl. 1 x E27, max. 40 W



304300132

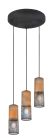

Ø 28 cm, ↓ 150 cm
 excl. 3 x E27, max. 40 W



304330332



↔ 65 x 9 cm, ↓ 150 cm
 excl. 4 x E27, max. 40 W



304300432



↓ 150 cm, Ø 23 cm
 excl. 3 x E14, max. 40 W



404300332







TOSH

Metall, Schwarz matt, Holz · metal, black mat, wood ·
 metale, noir mat, bois · metaal, mat zwart, hout · metal, estera negra, madera ·
 metallo, nero opaco, di legno · metal, negru mat, lemn · metalli, mattamusta, puu ·
 metal, czarny mat, drewno

Empfohlen:
 recommended: Filament LED E14, 4 W
 470 lm, 3.000 K



983-400



↔ 9 x 13,7 cm, ↕ 19,5 cm
 excl. 1 x E14, max. 40 W



804370132



↔ 26 x 9 cm, ↓ 19,5 cm
 excl. 2 x E14, max. 40 W



804370232



↔ 44 x 9 cm, ↓ 19,5 cm
 excl. 3 x E14, max. 40 W



804300332



↔ 22 x 22 cm, ↓ 19,5 cm
 excl. 4 x E14, max. 40 W



804300432



↓ 40 cm, ↔ 15 x 18 cm
 excl. 1 x E14, max. 40 W



504300132





RUNA

Metall, Schwarz matt, Sisal · metal, black mat, Sisal ·
 metale, noir mat, Sisal · metaal, mat zwart, Sisal · metal, estera negra, Sisal ·
 metallo, nero opaco, Sisal · metal, negru mat, Sisal · metalli, mattamusta, Sisal ·
 metal, czarny mat, Sizal

258



Ø 25 cm, ↑ 150 cm
 excl. 1 x E27, max. 40 W



303000132



Ø 35 cm, ↑ 150 cm
 excl. 1 x E27, max. 40 W



303090132



↔ 90 x 35 cm, ↑ 150 cm
 excl. 2 x E27, max. 40 W



303000232



↑ 150 cm, Ø 35 cm
 excl. 1 x E27, max. 40 W



403000132





VINTAGE

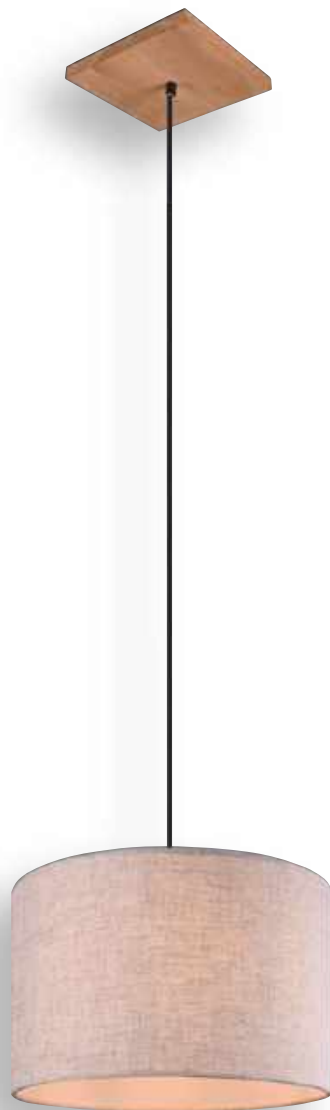

ELMAU

Holz, Stoffschirm · wood, fabric shade ·
bois, abat-jour tissu · hout, Stoffen kap · mader, Pantalla de tela ·
di legno, paralume in tessuto · lemn, abajur textil · puu, kangas varjostin ·
drewno, Klosz z materiału



Ø 35 cm, ↓ 150 cm
excl. 1 x E27, max. 60 W



302100130



↔ 100 x 20 cm, ↓ 150 cm
excl. 4 x E27, max. 60 W



302100430



↓ 40 cm, Ø 18 cm
excl. 1 x E14, max. 40 W



502100130





ROTIN

Rattangeflecht, Grau antik · rattan meshwork, antique grey ·
 maillage rotin, gris ancien · rotan vlechtwerk, antiek grijs · malla de rattan, gris antiguo ·
 reticolo rattan, grigio antico · impletitura ratan, antic gri · rottinki, antiikki harmaa ·
 rattan, starodawny szary



↓ 40 cm, Ø 18 cm
 excl. 1 x E14, max. 40 W



510900111



↓ 165 cm, Ø 39 cm
 excl. 1 x E27, max. 60 W



410900111



Ø 39 cm, ↓ 150 cm
 excl. 1 x E27, max. 60 W



310900111



Ø 70 cm, ↓ 150 cm
 excl. 5 x E14, max. 40 W



110900511





264

ROPE

Metall, Altmessing · metal, old brass ·
 metale, laiton fumé · metaal, oud brons · metal, bronze viejo ·
 metallo, ottone invecchiato · metal, bronz antic · metalli, antiikkimessinki ·
 metal, patyna

Leuchtmittel · Light sources · Ampoules · Lichtbronnen · Fuentes de luz ·
 Lampadine · Becuri · Valonlähteet · Źródła światła

Seite/page 663 - 665



Ø 12 cm, ↑ 150 cm
 excl. 1 x E27, max. 60 W



310100104



Ø 12 cm, ↑ 150 cm
 excl. 2 x E27, max. 60 W



310100204

JUDITH

Glas klar · clear glass ·
verre claire · helder glas ·
vidrio claro · vetro chiaro ·
sticlă transparentă · kirkas lasi ·
przezroczyste szkło

Empfohlen:
recommended: Filament LED E27, 6 W
420 lm, 2.700 K



987-679



265



Ø 24,5 cm, ↑ 150 cm
excl. 1 x E27, max. 60 W



302900102



CORD

Metall, Stoffkabel · metal, fabric sheathed cable ·
 metale, câble gainé de tissu · metaal, kabel met stofmantel ·
 metal, cable forrado de tela · metallo, cavo rivestito in tessuto ·
 metal, țesătură din fibră de sticlă · metalli, kangaspäällysteinen kaapeli ·
 metal, kabel z osłoną z tkaniny

Leuchtmittel · Light sources · Ampoules · Lichtbronnen · Fuentes de luz ·
 Lampadine · Becuri · Valonlähteet · Źródła światła

Seite/page 663 - 665



Ø 12 cm, ↑ 150 cm
 excl. 1 x E27, max. 60 W



310100106
 310100107
 310100108
 310100161
 310100162

06 Chrom · chrome
 07 Nickel matt · nickel mat
 08 Messing matt · brass mat
 61 Grau antik · antique grey
 62 Kupfer antik · antique copper



↑ 150 cm, ↔ max. 180 cm
excl. 5 x E27, max. 60 W



310100561
310100562



61 Grau antik · antique grey
62 Kupfer antik · antique copper



GOTHAM

Metall, Silber antik · metal, antique silver ·
 metale, argint antique · metaal, antiek zilver · metal, plateado antiguo ·
 metallo, argento anticato · metal, argint antic · metalli, antiikkihopea ·
 metal, antyczne srebro

Empfohlen:
 recommended: Filament LED E27, 6 W
 420 lm, 2.700 K



987-679

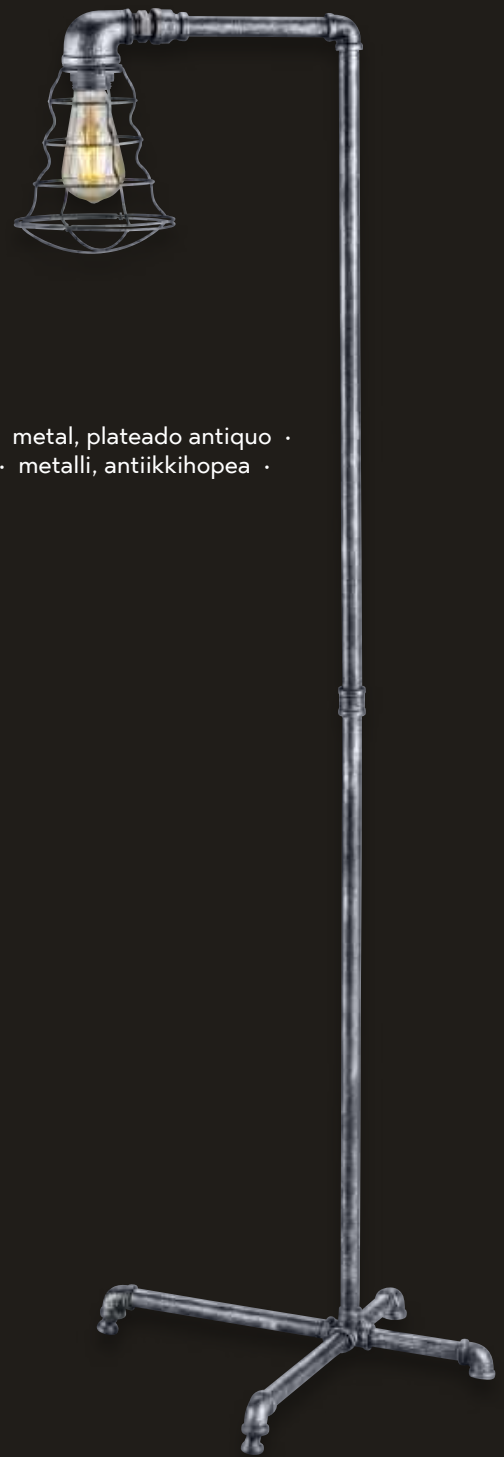

↑ 46,5 x 14,6 cm, ↗ 17,3 cm
 excl. 1x E27, max. 60 W



207000188



↑ 150 cm, Ø 14,6 cm
 excl. 1x E27, max. 60 W



307000188



↔ 103 x 46,3 cm, ↑ 150 cm
 excl. 6 x E27, max. 60 W



307000688



↑ 145,5 cm, ↗ 49,5 cm
 excl. 1x E27, max. 60 W



407000188



↑ 40 cm, ↗ 40 cm
 excl. 1x E27, max. 60 W



507000188





32

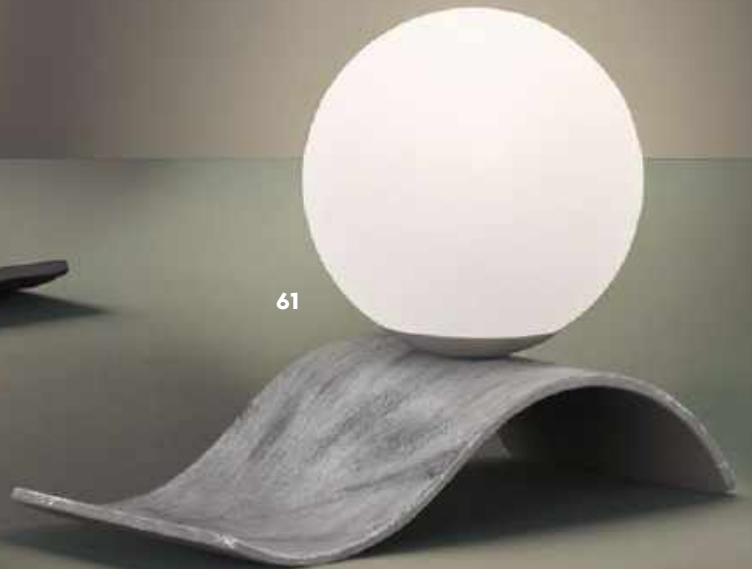

61



62

LARA

Metall, Glas matt · metal, mat glass ·
 metallo, vetro sabbato · metal, sticla mata · metalli, matalasi ·
 metal, szklo matowane



↔ 28 x 15 cm, ↑ 21 cm
 excl. 1 x E14, max. 28 W



508400132
 508400161
 508400162



32 Schwarz matt · black mat
 61 Grau antik · antique grey
 62 Kupfer antik · antique copper

NO. 5

Metall, Silber antik · metal, antique silver ·
metale, argent antique · metaal, antiek zilver ·
metal, plateado antiguo · metallo, argento anticato ·
metal, argint antic · metalli, antiikkihopea ·
metal, antyczne srebro



271



↑ 134 cm, ↔ 60 cm
excl. 1 x E27, max. 40 W



404200188



BIRTE

Metall, Glas klar · metal, clear glass ·
 metale, verre claire · metaal, helder glas ·
 metal, vidrio claro · metallo, vetro chiaro ·
 metal, sticlă transparentă · metalli, kirkas lasi ·
 metal, przezroczyste szkło

Empfohlen:
 recommended: Filamnet LED E14, 4 W
 470 lm, 3.000 K



989-400



02

61

62



Ø 14,5 cm, ↑ 150 cm
 excl. 1 x E14, max. 40 W



303800102
 303800161
 303800162



Ø 12,5 cm, ↑ 22 cm
 excl. 1 x E14, max. 40 W



503800102
 503800161
 503800162



02 Schwarz · black
 61 Grau antik · gray antique
 62 kupferfarbig antik · copper-coloured antique



Ø 30 cm, ↑ 120 cm
excl. 5 x E14, max. 40 W



303800517



EDDA

Metall kupferfarbig antik, Glas · metal antique copper, glass · metale cuivre ancien, verre · metaal antiek koper, glas · metal cobre antiguo, vidrio · metallo rame antico, vetro · metal cupru antic, sticla · metalli antiikki kupari, lasi · metal antyczne miedzi, szkło

Empfohlen:
recommended: Filament LED E27, 6 W
600 lm, 3.000 K



987-600



ASTRID

Metall, Glas klar · metal, clear glass · metale, verre claire · metaal, helder glas · metal, vidrio claro · metallo, vetro chiaro · metal, sticla transparentă · metalli, kirkas lasi · metal, przezroczyste szkło

Empfohlen:
recommended: Filament LED E14, 4 W
470 lm, 3.000 K



989-400



Ø 26,5 cm, ↑ 150 cm
excl. 1 x E27, max. 60 W



340100162



Ø 15 cm, ↑ 28 cm
excl. 1 x E14, max. 40 W



502700102



Ø 14,5 cm, ↑ 150 cm
excl. 1 x E14, max. 40 W



302700102

61

62

FISHERMAN

Metall, Glas klar · metal, clear glass ·
 metale, verre claire · metaal, helder glas · metal, vidrio claro ·
 metallo, vetro chiaro · metal, sticlă transparentă · metalli, kirkas lasi ·
 metal, przezroczyste szkło

275



Ø 32 cm, ↑ 150 cm
 excl. 1 x E27, max. 28 W



304500104
 304500161
 304500162



04 Altmessing · old brass
 61 Grau antik · gray antique
 62 kupferfarbig antik · copper-coloured antik

VINTAGE



01



02

SANNA

Metall · metal ·
metale · metaal · metal · metallo ·
metal · metalli · metal

276



Ø 25 cm, ↑ 150 cm
excl. 1 x E27, max. 60 W



300900101
300900102



Ø 39 cm, ↑ 150 cm
excl. 1 x E27, max. 60 W



300700101
300700102



01 Weiß · white
02 Schwarz · black





TANJA

Metall · metal ·
metale · metaal · metal · metallo ·
metal · metalli · metal





61

JOHANN

Metall, Grau antik oder Kupfer antik · metal, antique grey or antique copper ·
 metale, gris ancien ou cuivre ancien · metaal, antiek grijs of antiek koper ·
 metal, gris antiguo o cobre antiguo · metallo, grigio antico o rame antico ·
 metal, antic gri sau cupru antic · metalli, antiikki harmaa tai antiikki kupari ·
 metal, starodawny szary lub antyczne miedzi

Empfohlen:

recommended: Filament-LED E27, 4 W
 400 lm, 3.000 K



987-400



62



Ø 40 cm, ↓ 17 cm
 excl. 1 x E27, max. 60 W



606900161
 606900162



↓ 150 cm, Ø 40 cm
 excl. 1 x E27, max. 60 W



306900161
 306900162



61 Grau antik · antique grey
 62 Kupfer antik · antique copper



61



62

JACOB

Metall, Grau antik oder Kupfer antik · metal, antique grey or antique copper ·
metale, gris ancien ou cuivre ancien · metaal, antiek grijs of antiek koper ·
metal, gris antiguo o cobre antiguo · metallo, grigio antico o rame antico ·
metal, antic gri sau cupru antic · metalli, antiikki harmaa tai antiikki kupari ·
metal, starodawny szary lub antyczne miedzi

Empfohlen:
recommended: Filament LED E27, 6 W
600 lm, 3.000 K



988-660



279

Ø 40 cm, ↑ 150 cm
excl. 1 x E27, max. 60 W



305100161
305100162



61 Grau antik · antique grey
62 Kupfer antik · antique copper



04



61



62

LINDA

Metall, Glas klar · metal, clear glass ·
 metale, verre claire · metaal, helder glas ·
 metal, vidrio claro · metallo, vetro chiaro ·
 metal, sticlă transparentă · metalli, kirkas lasi ·
 metal, przezroczyste szkło

Empfohlen:
 recommended: Filament LED E14, 4 W
 470 lm, 3.000 K



990-400



Ø 18 cm, ↑ 32,5 cm
 excl. 1 x E14, max. 40 W



503500104
 503500161
 503500162



04 Altmessing · old brass
 61 Grau antik · gray antique
 62 kupferfarbig antik · copper-coloured antik



JASMIN

Metall · metal ·
metale · metaal · metal · metallo ·
metal · metalli · metal



Ø 19 cm, ↑ 150 cm
excl. 1 x E14, max. 40 W



303700104
303700161
303700162



Ø 19 cm, ↑ 36 cm
excl. 1 x E14, max. 40 W

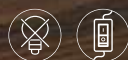

503700104
503700161
503700162



04 Altmessing · old brass
61 Grau antik · gray antique
62 kupferfarbig antik · copper-coloured antique





Pendelleuchten & Kronen

Pendants & chandeliers
Lustres & suspensions
Hanglampen & kroonluchters
Colgantes y Lámparas
Lampadari e sospensioni
Lustre si pendule
Riippu- & kruunu
Wiszące i żyrandole



TUBULAR

Metall, Weiß matt oder Schwarz matt · metal, white mat or black mat ·
 metale, blanc mat ou noir mat · metaal, wit mat of mat zwart · metal, estera blanca o estera negra ·
 metallo, bianco opaco o nero opaco · metal, alb mat sau negru mat · metalli, valkoinen matto tai musta matto ·
 metal, biały mat lub czarny mat

LED SWITCHDIMMER



Ø 40 cm, ↓ 150 cm
 incl. 11 x SMD-LED, 2,5 W
 11 x 220 lm, 3.000 K



321691131
321691132

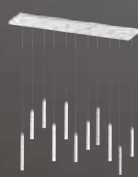

↔ 115 x 15 cm, ↓ 150 cm
 incl. 11 x SMD-LED, 2,5 W
 11 x 220 lm, 3.000 K



321611131
321611132



31 Weiß matt · white mat
32 Schwarz matt · black mat





CURL

Metall, Weiß matt, Schwarz matt oder goldfarbig · metal, white mat, black mat or gold ·
 metale, blanc mat, noir mat ou or · metaal, wit mat, mat zwart of goud ·
 metal, estera blanca, estera negra o oro · metallo, bianco opaco, nero opaco o oro ·
 metal, alb mat, negru mat sau aur · metalli, mattavalkoinen, mattamusta tai kultaa ·
 metal, biały mat, czarny mat lub złota

LED SWITCHDIMMER



Ø 55 cm, ↑ 150 cm
 incl. SMD-LED, 33 W
 2.800 lm, 3.000 K



325110132
 325110179



Ø 55 cm, ↑ 150 cm
 incl. SMD-LED, 33 W
 3.500 lm, 4.000 K



325110131



31 Weiß matt · white mat
 32 Schwarz matt · black mat
 79 goldfarbig · gold

4.000 Kelvin



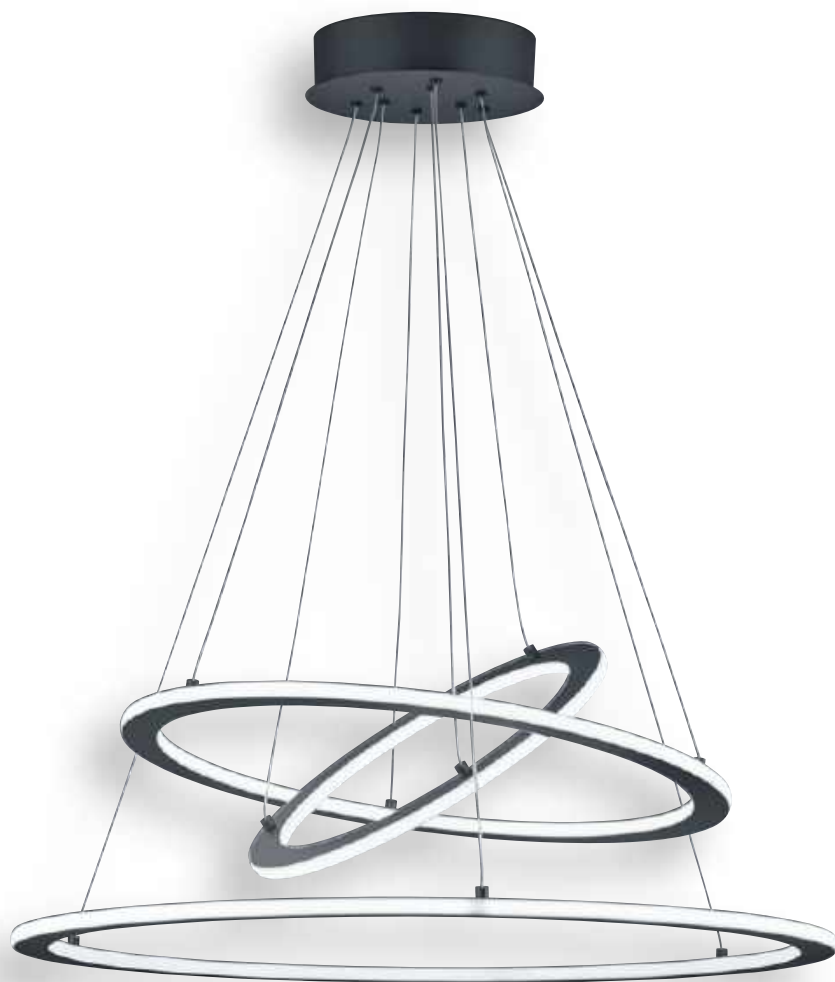

DURBAN

Metall, Nickel matt oder Anthrazit · metal, nickel mat or anthracite ·
 metale, nickel mat ou antracite · metaal, nikkel mat of antraciet ·
 metal, níquel mate o antracita · metallo, nichel opaco o antracite ·
 metal, nichel mat sau antracit · metalli, harjattu teräs tai antrasiitti ·
 metal, nikiel mat lub antracyt

LED SWITCHDIMMER



Ø 60 cm, ↑ 200 cm
 incl. SMD-LED, 40 W
 5.000 lm, 3.000 K



321910207
321910242



Ø 80 cm, ↑ 200 cm
 incl. SMD-LED, 75 W
 8.000 lm, 3.000 K



321910307
321910342



07 Nickel matt · nickel mat
42 Anthrazit · anthracite



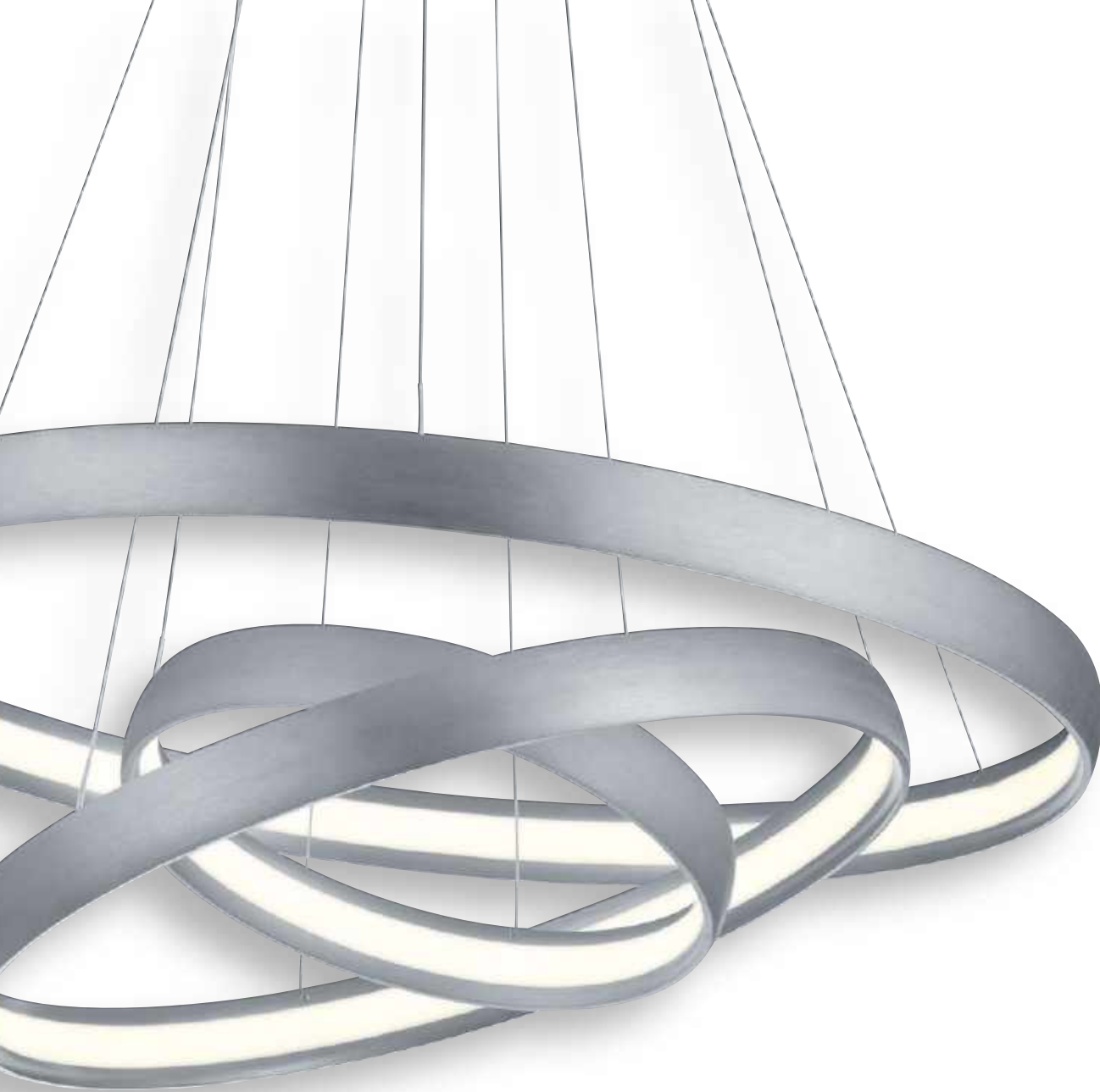

MACAU

Aluminium gebürstet · brushed aluminium ·
aluminium balayé · geborsteld aluminium · aluminio pulido ·
alluminio spazzolato · aluminiu lucios · harjattu alumiini ·
aluminium szczotkowane

LED SWITCHDIMMER



Ø 75 cm, ↓ max. 200 cm
incl. SMD-LED, 64 W
6.000 lm, 3.000 K



325610305





SATURN

Chrom, Acryl · chrome, acryl ·
 chrome, acryl · chroom, acryl · cromo, acrílico ·
 cromo, acrílico · crom, acrilic · kromi, akryyli ·
 chrom, akryl



Ø 50 cm, ↓ 130 cm
 incl. SMD-LED, 36 W
 3.500 lm, 3.000 K



376013606



CAVALLO

Aluminium gebürstet · brushed aluminium ·
aluminium balayé · geborsteld aluminium · aluminio pulido ·
alluminio spazzolato · aluminiu lucios · harjattu alumiini ·
aluminium szczotkowane



293



↔ 100 x 5 cm, ↓ 95 - 160 cm
incl. 5 x SMD-LED, 4,3 W
5 x 430 lm, 3.000 K



379090505



TRAJAN

Metall, Nickel matt, Messing matt oder Schwarz matt · metal, nickel mat, brass mat or black mat ·
 metale, nickel mat, laiton mat ou noir mat · metaal, nikkel mat, messing mat of mat zwart ·
 metal, níquel mate, bronce mate o estera negra · metallo, nichel opaco, ottone satinato o nero opaco ·
 metal, nichel mat, bronz mat sau negru mat · metalli, harjattu teräs, mattamessinki tai mattamusta ·
 metal, nikiel mat, mosiądz mat lub czarny mat

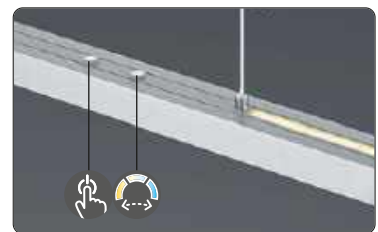

↔ 95 - 150 cm, ↑ 95 - 150 cm
 incl. SMD-LED, 42 W, 4.000 lm
 incl. 2 x SMD-LED, 6 W, 2 x 500 lm
 2.700 - 5.000 K



375310507
375310508
375310532

07 Nickel matt · nickel mat
08 Messing matt · brass mat
32 Schwarz matt · black mat



Ausziehbar · Extendible ·
 extensible · Verlengbaar · Extensible ·
 Estensibile · extensibil · Jatkettava ·
 Rozsuwalny

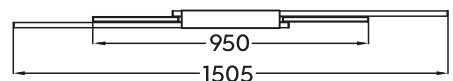



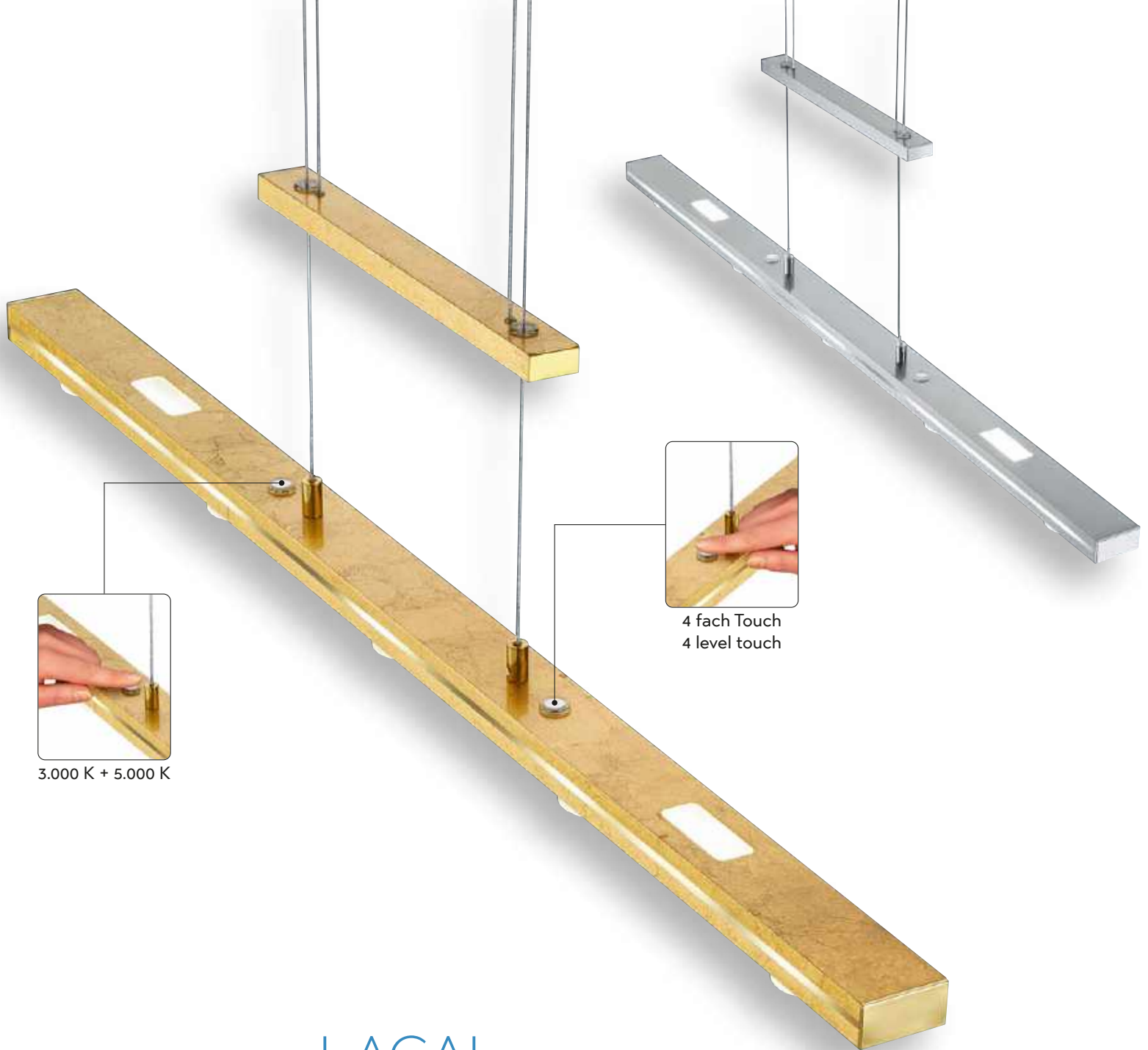

3.000 K + 5.000 K



4 fach Touch
4 level touch

LACAL

Nickel matt oder goldfarbig · nickel mat or gold ·
nickel mat ou or · nikkell mat of goud · níquel mate o oro ·
nichel opaco o oro · nichel mat sau aur · harjattu teräs tai kultaa ·
nikiel mat lub złota

Gibt Licht nach oben und unten · up and down lighting ·
point lumineux en haut et en bas · lichtpunt boven en onder ·
luz de arriba y abajo · luce su e giù · sus și în jos lumina ·
ylös ja alas valoa · w górę iw dół światło



↔ 100 cm, ↑ 95 - 160 cm
incl. 7 x SMD-LED, 3,5 W
7 x 350 lm, 3.000 + 5.000 K



379190707
379190732
379190779

07 Nickel matt · nickel mat
32 schwarz matt · black mat
79 goldfarbig · gold



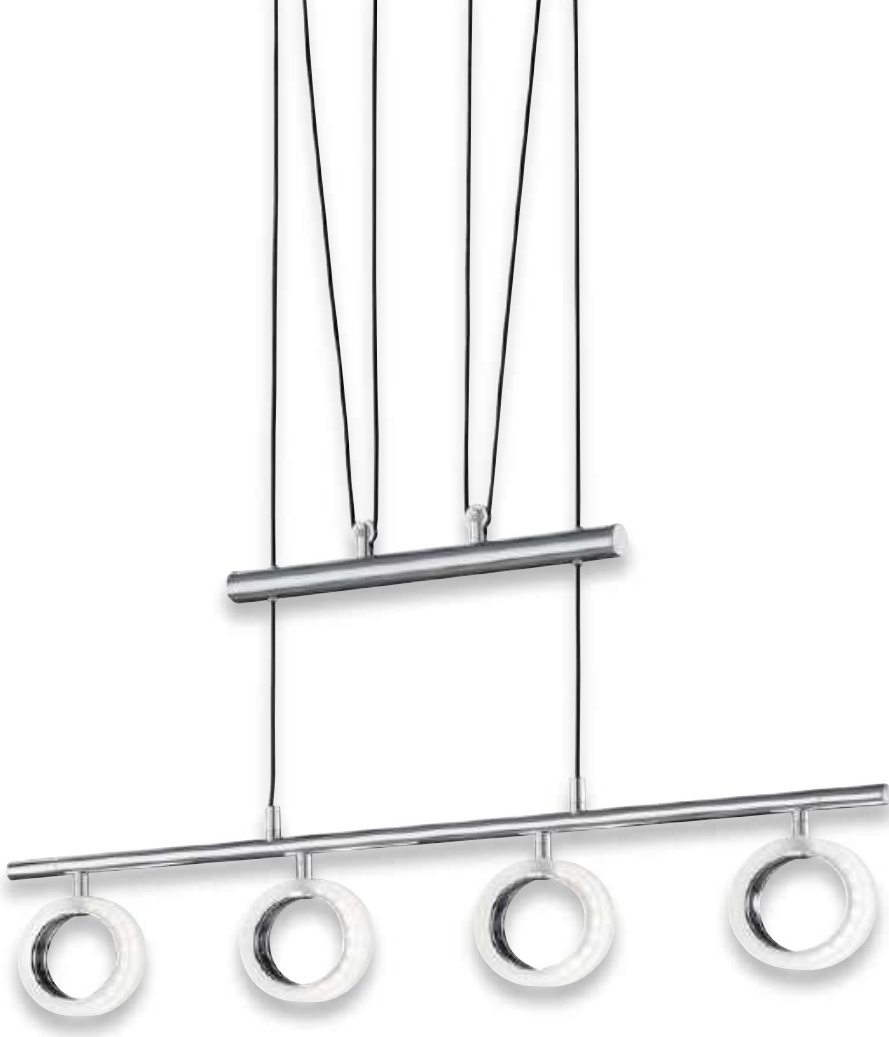

CORLAND II

Chrom, Acryl · chrome, acryl ·
 chrome, acryl · chroom, acryl · cromo, acrílico ·
 cromo, acrilico · crom, acrylic · kromi, akryyli ·
 chrom, akryl



CALVARO

Aluminium gebürstet, Acryl · brushed aluminium, acryl ·
 aluminium balayé, acryl · geborsteld aluminium, acryl ·
 aluminio pulido, acrílico · alluminio spazzolato, acrilico ·
 aluminu lucios, acrilic · harjattu alumiini, akryyli ·
 aluminium szczotkowane, akryl



↔ 80 cm, ↑ 85 - 170 cm
 incl. 4 x SMD-LED, 3,5 W
 4 x 370 lm, 3.000 K



374210406



↔ 80 x 2,5 cm, ↑ 90 - 150 cm
 incl. SMD-LED, 20 W
 1.900 lm, 3.000 K



377690105





STAKKATO

Nickel matt, Glas satiniert · nickel mat, satinated glass ·
nickel mat, verre satiné · nikkell mat, gesatineerd glas ·
níquel mate, vidrio satinado · nichel opaco, vetro satinato ·
nichel mat, sticla satinata · harjattu teräs, satinoitu lasi ·
nikiel mat, szkło satynowe

299



↔ 87 x 10 cm, ↓ 95 - 150 cm
incl. 3 x SMD-LED, 4,5 W
3 x 430 lm, 3.000 K



377310307



LIFT ME

Innovative Höhenverstellung ohne Gegengewicht · Innovative height adjustment without counterweight · Nouveau! Réglage de la hauteur sans contrepoids · Innovatieve hoogteverstelling zonder contragewicht · Innovador sistema de ajuste de altura sin necesidad de contrapeso · Regolazione innovativa dell'altezza senza contrappeso · Ajustare inovativa a inaltimii fara contragreutate · Innovatiivinen korkeuden säätö ilman vastapainoa · Innowacyjna regulacja wysokości bez przeciwwagi



ALEGRO

Nickel matt, Glas opal · nickel mat, opal glass · nickel mat, verre opale · nikkellat, opaalglas · níquel mate, vidrio opal · nichel opaco, vetro opale · nichel mat, sticla opala · harjattu teräs, opaalilasi · nikkellat, szkło opal

LED SWITCHDIMMER



↔ 100 cm, ↑ 95 - 160 cm
incl. 4 x SMD-LED, 6 W
4 x 630 lm, 3.000 K



325510407



↔ 130 cm, ↑ 95 - 160 cm
incl. 5 x SMD-LED, 6 W
5 x 630 lm, 3.000 K



325510507





COVENTRY

Metall, Anthrazit oder titanfarbig · metal, anthracite or titan ·
 metale, antracite ou titane · metaal, antraciet of titaan · metal, antracita o titán ·
 metallo, antracite o titano · metal, antracit sau titaniu · metalli, antrasiitti tai titaani ·
 metal, antracyt lub tytanowy



2.700 K



3.800 K



5.000 K



↔ 120 x 15 cm, ↑ 150 cm
 incl. SMD-LED, 35 W
 3.700 lm, 2.700 + 3.800 + 5.000 K



371710142
 371710187



42 Anthrazit · anthracite
87 titanfarbig · titanium-coloured





BARON

Metall, Weiß matt oder Schwarz matt, Acryl · metal, white mat or black mat, acryl ·
metale, blanc mat ou noir mat, acryl · metaal, wit mat of mat zwart, acryl ·
metal, estera blanca o estera negra, acrílico · metallo, bianco opaco o nero opaco, acrilico ·
metal, alb mat sau negru mat, acrilic · metalli, mattavalkoinen tai mattamusta, akryyli ·
metal, biały mat lub czarny mat, akryl · metal, beyaz mat veya siyah mat, akrilik

304



Ø 52 cm, ↑ 150 cm
excl. 4 x E27, max. 40 W



309800431
309800432



31 Weiß matt · white mat
32 Schwarz matt · black mat



HOLLY

Metall, Weiß matt · metal, white mat ·
metale, blanc mat · metaal, wit mat · metal, estera blanca · metallo, bianco opaco ·
metal, alb mat · metalli, mattavalkoinen · metal, biały mat

305



Ø 48 cm, ↑ 150 cm
excl. 3 x E27, max. 42 W



307400331



RODDIK

Polyresin, betonfarbig · polyresin, concrete look ·
 polyresin, couleur beton · polyresin, beton kleur ·
 poliresina, color concreto · poliestere, calcestruzzo ·
 polirasina, culoare beton · polyresiini, konkreettisia väri ·
 polyresin, konkretny kolor

306



Ø 16 cm, ↑ 150 cm
 excl. 1 x E14, max. 40 W



301100178



↔ 80 cm, ↑ 150 cm
 excl. 3 x E14, max. 40 W



301100378





JAMIRO

Metall, Schwarz matt, Beton · metal, black mat, concrete ·
 metale, noir mat, béton · metaal, mat zwart, beton ·
 metal, estera negra, hormigón · metallo, nero opaco, cemento ·
 metal, negru mat, beton · metalli, mattamusta, betoni ·
 metal, czarny mat, beton

Empfohlen:
 recommended: Filament LED E27, 4 W
 470 lm, 3.000 K



987-400



Ø 15 cm, ↓ 150 cm
 excl. 1 x E27, max. 40 W



309200132



Ø 25 cm, ↓ 150 cm
 excl. 3 x E27, max. 40 W



309230332



↔ 80 x 15 cm, ↓ 150 cm
 excl. 4 x E27, max. 40 W



309200432



↓ 24 cm, Ø 15 cm
 excl. 1 x E27, max. 40 W



509200132

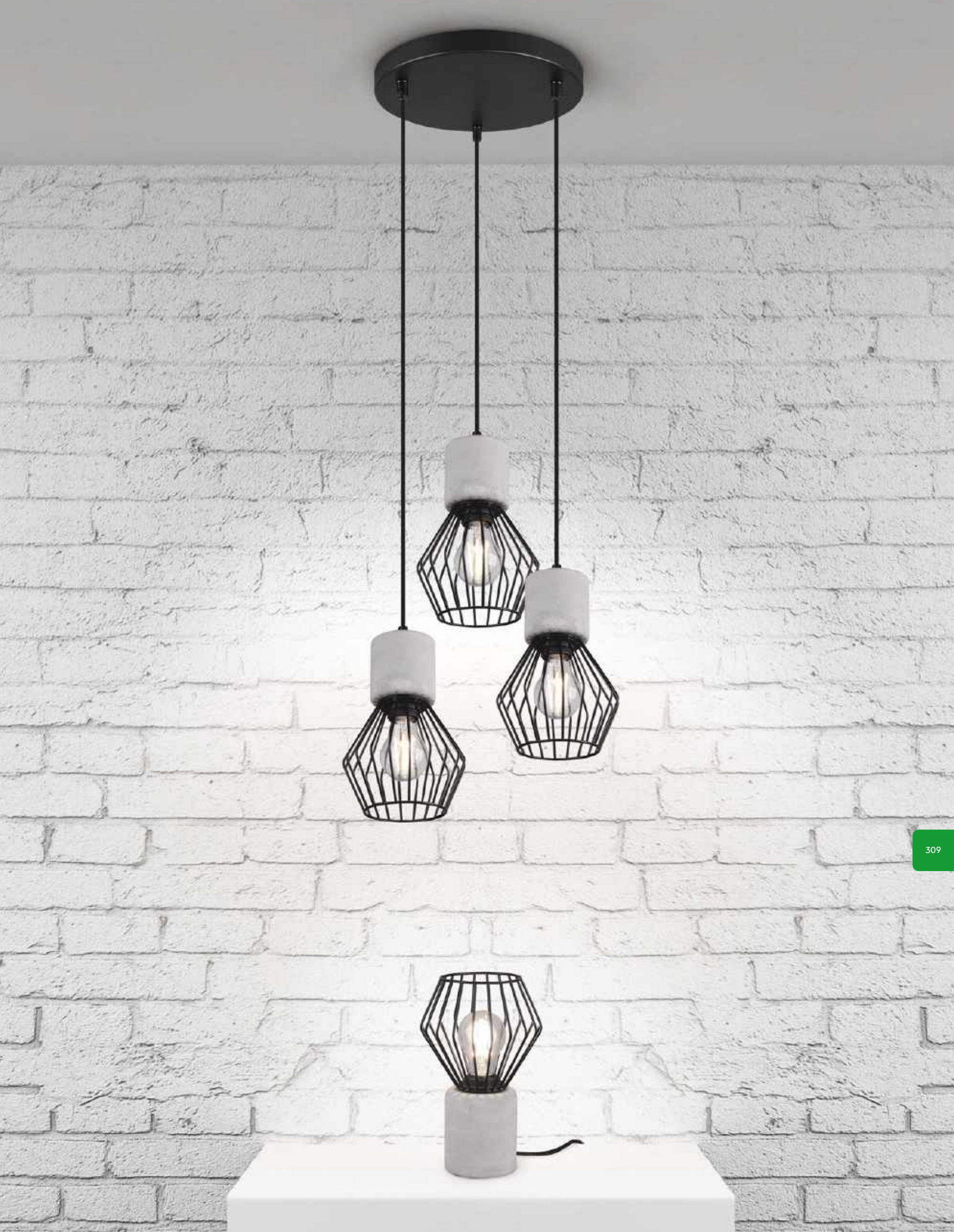



GINSTER

Metall, Chrom oder Schwarz matt · metal, chrome or black mat ·
 metale, chrome ou noir mat · metaal, chroom of mat zwart ·
 metal, cromo o estera negra · metallo, cromo o nero opaco ·
 metal, crom sau negru mat · metalli, kromi tai mattamusta ·
 metal, chrom lub czarny mat



Ø 40 cm, ↑ 140 cm
 incl. 3 x E27-LED, 8 W
 3 x 260 lm, 2.700 K



323390306



↔ 63 x 12 cm, ↑ 140 cm
 incl. 3 x E27-LED, 8 W
 3 x 260 lm, 2.700 K



323310306



Ø 40 cm, ↑ 140 cm
 incl. 3 x E27-LED, 8 W
 3 x 560 lm, 2.700 K



323390332



↔ 63 x 12 cm, ↑ 140 cm
 incl. 3 x E27-LED, 8 W
 3 x 560 lm, 2.700 K



323310332



06 Chrom · chrome

32 Schwarz matt · black mat

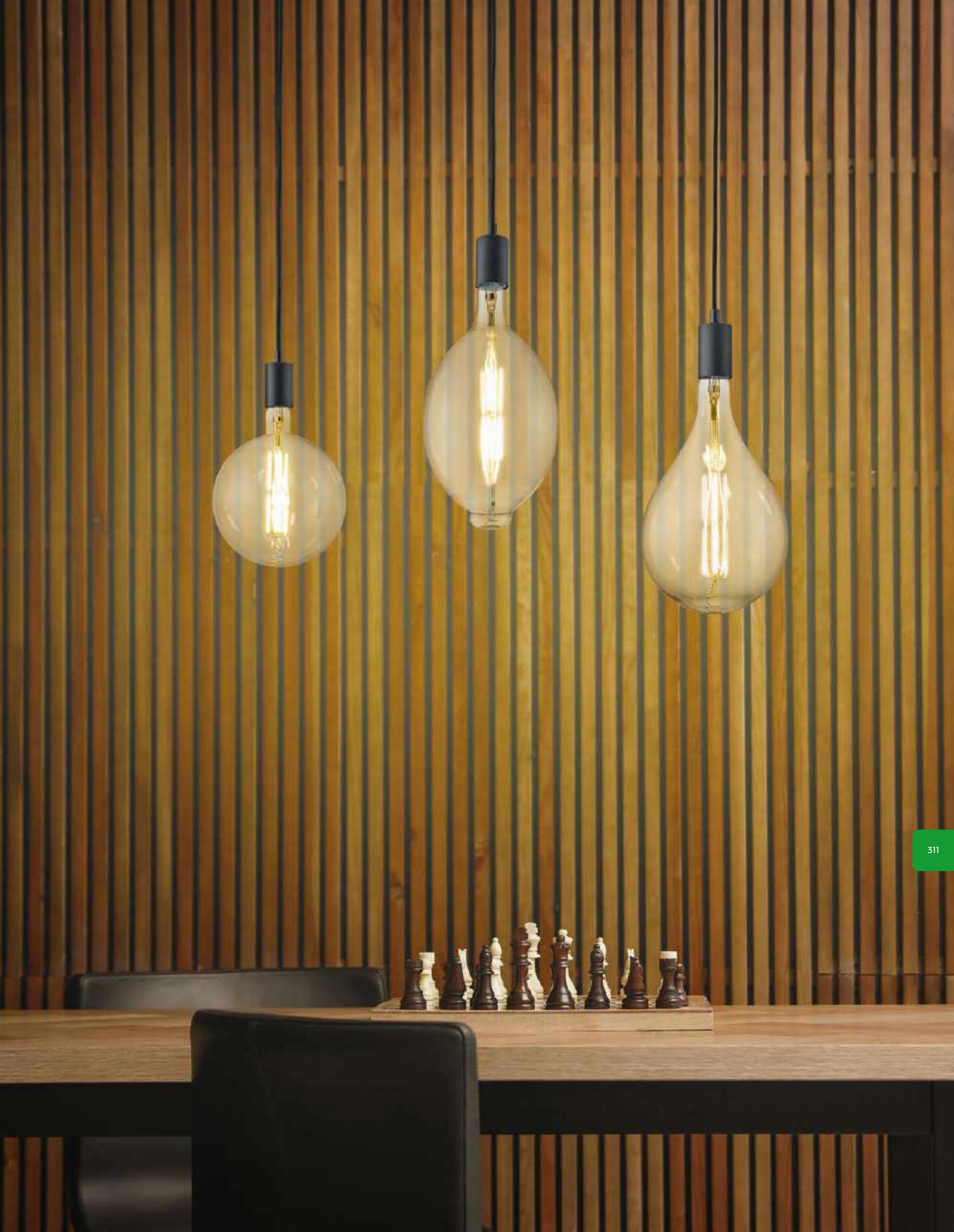



CALAIS

Glas amber oder Rauchglas · glass amber or smoked glass ·
verre ambre ou verre fumé · glas amber of rookglas ·
vidrio ámbar o vidrio ahumado · vetro ambrá o vetro fumé' ·
sticla amber sau sticla fumurie · lasi meripihka tai savulasi ·
szkło bursztynowy lub szkło przydymione

312



↓ 130 cm, Ø 20 cm
excl. 1 x E27, max. 60 W



304800100
304800142



↓ 130 cm, Ø 39,5 cm
excl. 1 x E27, max. 60 W



304900100
304900142



00 Natur · nature
42 Anthrazit · anthracite





00



42

DOVER

Glas amber oder Rauchglas · glass amber or smoked glass ·
verre ambre ou verre fumé · glas amber of rookglas ·
vidrio ámbar o vidrio ahumado · vetro ambra o vetro fume' ·
sticla amber sau sticla fumurie · lasi meripihka tai savulasi ·
szkło bursztynowy lub szkło przydymione





26



30

BOOLAN

Holz · wood ·
bois · hout · mader · di legno ·
lemn · puu · drewno

Empfohlen:
recommended: Filament LED E27, 6 W
420 lm, 2.700 K



988-679

314



Ø 50 cm, ↑ 150 cm
excl. 1 x E27, max. 60 W



305900126
305900130



26 Braun · brown
30 holzfarbig hell · light colored wood



MINSK

Metall, Acryl · metal, acryl ·
metale, acryl · metaal, acryl · metal, acrílico ·
metallo, acrilico · metal, acrylic · metalli, akryyli ·
metal, akryl

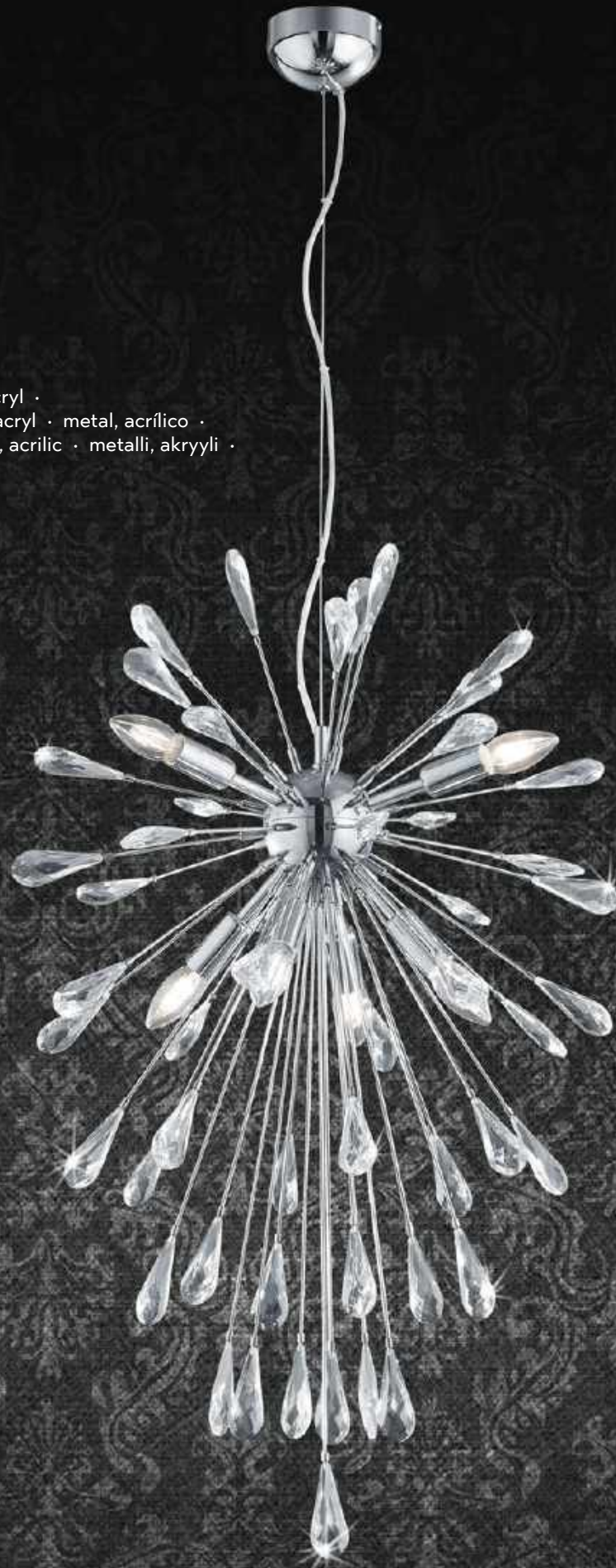

316



Ø 50 cm, ↓ max. 180 cm
excl. 7 x E14, max. 28 W



308600706



CANDELA

Aluminium gebürstet/Chrom oder Messing matt/Messing poliert · brushed aluminium/chrome or brass mat/polished brass · aluminium balayé/chrome ou laiton mat/laiton polis · geborsteld aluminium/chroom of messing mat/gepolijst messing · alumínio pulido/cromo o bronze mate/bronze · alluminio spazzolato/cromo o ottone satinato/ottone lucido · aluminiu lucios/crom sau bronz mat/bronz · harjattu alumiini/kromi tai mattamessinki/messinki · aluminium szczotkowane/chrom lub mosiądz mat/mosiądz polerowany



Ø 56 cm, ↓ 150 cm
excl. 4 x E14, max. 40 W



102000403
102000405



03 Messing poliert · polished brass
05 Aluminium gebürstet · brushed aluminium



02



01

318

LORELEY

Chrom, Acryl, Stoffschirm · chrome, acryl, fabric shade ·
chrome, acryl, abat-jour tissu · chroom, acryl, Stoffen kap ·
cromo, acrílico, Pantalla de tela · cromo, acrílico, paralume in tessuto ·
chrom, acrílic, abajur textil · kromi, akryyli, kangas varjostin ·
chrom, akryl, Klosz z materiału



Ø 50 cm, ↑ 150 cm
excl. 3 x E14, max. 40 W



309300301
309300302



01 Weiß · white
02 Schwarz · black





CORTEZ

Metall, Stoffschirm · metal, fabric shade ·
 metale, abat-jour tissu · metaal, Stoffen kap · metal, Pantalla de tela ·
 metallo, paralume in tessuto · metal, abajur textil · metalli, kangas varjostin ·
 metal, Klosz z materiału



Ø 47 cm, ↑ 150 cm
 excl. 3 x E14, max. 40 W



110600331
 110600378



Ø 66 cm, ↑ 150 cm
 excl. 5 x E14, max. 40 W



110600531
 110600578



31 Weiß matt · white mat
78 betonfarbig · concrete look





ONYX

Metall, Anthrazit, innen goldfarbig · metal, anthracite, gold colored inside ·
 metale, antracite, Or · metaal, antraciet, Binnenkant goudkleur ·
 metal, antracita, Interior en color dorado · metallo, antracite, interno colore oro ·
 metal, antracit, interior culoare aurie · metalli, antrasiitti, sisäosa kullanvärinen ·
 metal, antracyt, wewnątrz złoty

322



Ø 15 cm, ↓ 150 cm
 excl. 1 x E27, max. 42 W



301300142



Ø 35 cm, ↓ 150 cm
 excl. 3 x E27, max. 42 W



301300342



↔ 90 cm, ↓ 150 cm
 excl. 4 x E27, max. 42 W



301300442





OTTAWA

Metall goldfarbig · metal gold ·
metale or · metaal goud · metal oro · metallo oro ·
metal aur · metalli kultaa · metal złota



ROMINO II

Schwarz matt, Metall · black mat, metal ·
noir mat, metale · mat zwart, metaal ·
estera negra, metal · nero opaco, metallo ·
negru mat, metal · musta matto, metalli ·
czarny mat, metal



EVA

Metall · metal ·
metale · metaal · metal · metallo ·
metal · metalli · metal



Ø 50 cm, ↑ 150 cm
excl. 1 x E27, max. 60 W



305700179



Ø 50 cm, ↑ 150 cm
excl. 1 x E27, max. 60 W



308000132



Ø 25 cm, ↑ 150 cm
excl. 1 x E14, max. 40 W



306400179



RAMIRO

Schwarz matt, goldfarbig · black mat, gold ·
noir mat, or · mat zwart, goud · estera negra, oro ·
nero opaco, oro · negru mat, aur · musta matto, kultaa ·
czarny mat, złota



325

↔ 100 x 8,5 cm, ↑ 150 cm
incl. 4 x SMD-LED, 4,5 W
4 x 430 lm, 3.000 K



376410402



326

BOSTON

Nickel matt · nickel mat ·
nickel mat · nikkell mat · níquel mate · nichel opaco ·
nichel mat · harjattu teräs · nikiel mat



Ø 39 cm, ↓ 160 cm
excl. 1 x E27, max. 60 W



301800107



TRUMPET

Nickel matt oder Altmessing, Glas matt · nickel mat or old brass, mat glass · nickel mat ou laiton fumé, verre mat · nikkell mat of oud brons, mat glas · níquel mate o bronze viejo, vidrio mate · nichel opaco o ottone invecchiato, vetro sabbiato · nichel mat sau bronz antic, sticla mata · harjattu teräs tai antiikkimessinki, mattalasi · nikiel mat lub patyna, szkło matowane · mat nikel veyá antik piringç, mat cam

327



Ø 30 cm, † 150 cm
excl. 1 x E27, max. 60 W



303100104
303100107



04 Altmessing · old brass
07 Nickel matt · nickel mat



CARLOTTA

Metall · metal ·
metale · metaal · metal · metallo ·
metal · metalli · metal



CARLA

Metall · metal ·
metale · metaal · metal ·
metallo · metal · metalli ·
metal

STELLA

Metall · metal ·
metale · metaal · metal ·
metallo · metal · metalli ·
metal

328



Ø 14,3 cm
excl. 1 x E14, max. 28 W



305170107
305170131
305170132



Ø 6 cm
excl. 1 x GU10, max. 35 W



305470107
305470131
305470132



Ø 4,3 cm
excl. 1 x E27, max. 42 W



305270107
305270131
305270132



07 Nickel matt · nickel mat
31 Weiß matt · white mat
32 Schwarz matt · black mat

Keep on rolling

- ◆ 6 Meter Kabellänge
- ◆ kein Deckenanschluss erforderlich
- ◆ inkl. Schalter
- ◆ 6 metre long cable
- ◆ no ceiling connection required
- ◆ incl. switch
- ◆ longueur de câble de 6 mètres
- ◆ aucun raccordement au plafond requis
- ◆ incl. interrupteur
- ◆ 6 meter lange kabel
- ◆ geen plafondaansluiting vereist
- ◆ incl. schakelaar
- ◆ cable de 6 metros de largo
- ◆ no es necesaria conexión en el techo
- ◆ incl. interruptor
- ◆ cavo lungo 6 metri
- ◆ non è richiesto alcun collegamento a soffitto
- ◆ incl. interruttore
- ◆ lungimea de 6 m a cablului
- ◆ nu este necesară o conexiune în plafon
- ◆ incl. intrerupator
- ◆ 6 m kaapeli
- ◆ kattoliitääntää ei tarvita
- ◆ incl. kytkin
- ◆ przewód o długości 6 metrów
- ◆ nie jest wymagane połączenie sufitowe
- ◆ incl. przełącznik



Ø 14,3 cm
excl. 1 x E14, max. 28 W



305170167

DELIA

Metall, Nickel antik, Holz · metal, nickel antique, wood · metale, nickel antique, bois · metaal, antiek nikkel, hout · metal, níquel antiguo, madera · metallo, nickel anticato, di legno · metal, nichel antic, lemn · metalli, antiikkiteräs, puu · metal, aikiel antyczny, drewno

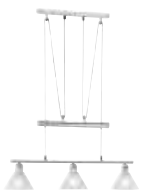
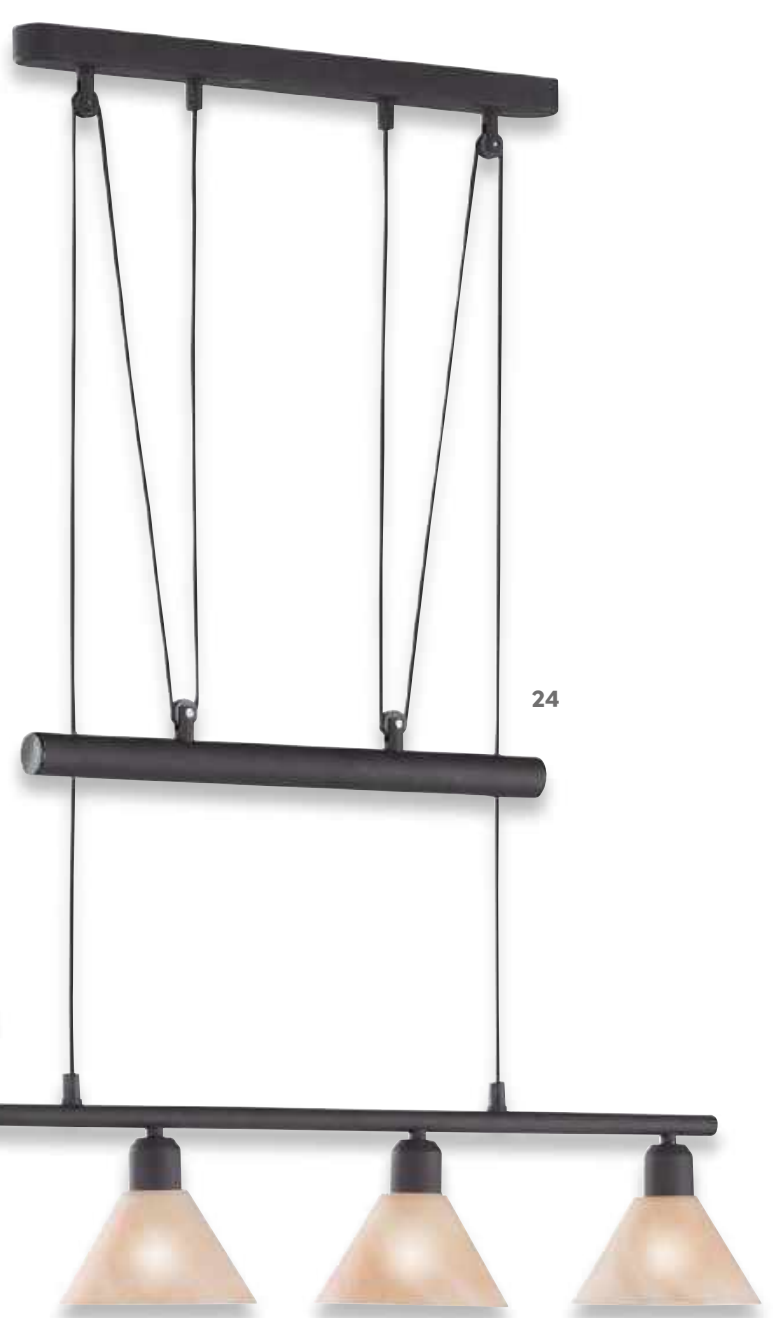

↔ 66 cm, ↓ 80 - 180 cm
excl. 3 x E14, max. 40 W



3751031-07
3751031-24



↔ 80 cm, ↓ 80 - 180 cm
excl. 4 x E14, max. 40 W



3751041-07
3751041-24



↔ 102 cm, ↓ 80 - 180 cm
excl. 5 x E14, max. 40 W



3751051-07
3751051-24



07 Nickel matt · nickel mat
24 rostfarbig · rusty



STAMINA

Nickel matt oder rostfarbig, Glas · nickel mat or rusty, glass ·
nickel mat ou rouille, verre · nikkell mat of roestkleur, glas ·
níquel mate o óxido, vidrio · nichel opaco o ruggine, vetro ·
nichel mat sau ruginiu, sticla · harjattu teräs tai rustiikki, lasi ·
nikiel mat lub miedz, szkło



MONTENDER

Nickel matt, Glas matt · nickel mat, mat glass ·
nickel mat, verre mat · nikkell mat, mat glas ·
níquel mate, vidrio mate · nichel opaco, vetro sabbiato ·
nichel mat, sticla mata · harjattu teräs, mattalasi ·
nikiel mat, szkło matowane

CARBONADO

Dekorglas, Chrom · glas decorated, chrome ·
verre décoré, chrome · decoratief glas, chroom · vidrio decorado, cromo ·
vetro decorato, cromo · sticla decorativa, crom · ornamentilasi, kromi ·
szkło dekoracyjne, chrom



Ø 43 cm, ↑ 150 cm
excl. 1 x E27, max. 40 W



302400106



Ø 40 cm, ↑ 150 cm
excl. 1 x E27, max. 60 W



301900107



COLIN

Metall, Glas · metal, glass ·
 metale, verre · metaal, glas · metal, vidrio ·
 metallo, vetro · metal, sticla · metalli, lasi ·
 metal, szkło

VIOLA

Glas alabasterfarbig · alabaster-coloured glass ·
 verre couleur albâtre · albastkleurig glas ·
 vidrio de color alabastro · vetro colore alabastro ·
 sticla culoare alabastru · lasi alabasteri väri ·
 szkło alabaster kolor



Ø 38,5 cm, ↑ 70 - 130 cm
 excl. 1 x E27, max. 60 W



301700107
 301700108



Ø 40 cm, ↑ 130 cm
 excl. 1 x E27, max. 60 W



3407011-07



07 Nickel matt · nickel mat
 08 Messing matt · brass mat



24

15

12

01

DIEGO

Kunststoff, Glas · plastic, glass ·
 plastique, verre · kunststof, glas · plástico, vidrio ·
 plastica, vetro · plastic, sticla · muovi, lasi ·
 plastik, szkło

334



Ø 30 cm, ↑ 125 cm
 excl. 1 x E27, max. 60 W



301400101
 301400112
 301400115
 301400124

01 Weiß · white
12 Blau · blue
15 Grün · green
24 Amber · amber



BAJO

Metall weiß · metal white ·
 metale blanc · metaal wit ·
 metal blanco · metallo bianco ·
 metal alb · metalli valkoinen ·
 metal biały



Ø 32,5 cm, ↑ 150 cm
 excl. 1 x E27, max. 40 W



307290101



ZUCCA

Chrom, Acryl · chrome, acryl ·
 chrome, acryl · chroom, acryl · cromo, acrílico ·
 cromo, acrílico · crom, acrylic · kromi, akryyli ·
 chrom, akryl



Ø 40 cm, ↑ 150 cm
 excl. 1 x E27, max. 60 W



304100100
 304100106



00 Transparent · transparent
01 Weiß · white
06 Chrom · chrome



19

18

00

15

PAPER

Papier · paper ·
papier · papier · papel · carta ·
hartie · paperi · papier



↑ 73,5 cm
excl. 1 x E27, max. 60 W
VE / moq: 25



3590010-01

336



Ø 40 cm, ↑ 47 cm
excl. 1 x E27, max. 60 W
VE / moq: 25



3491400-00



Ø 50 cm
excl. 1 x E27, max. 60 W
VE / moq: 25



3490500-00



Ø 40 cm
excl. 1 x E27, max. 60 W
VE / moq: 25



3490400-00
3490400-15
3490400-18
3490400-19



00 Weiß · white
15 Grün · green
18 Orange · orange
19 Türkis · turquoise







Wand- & Deckenleuchten

Wall- & Ceiling lamps
Plafonniers & appliques
Wandlampen & plafonnières
Appliques y plafones
Applique e plafoniere
Plafoniere si aplice
Seinä- & katto
Sufitowe i ścienne

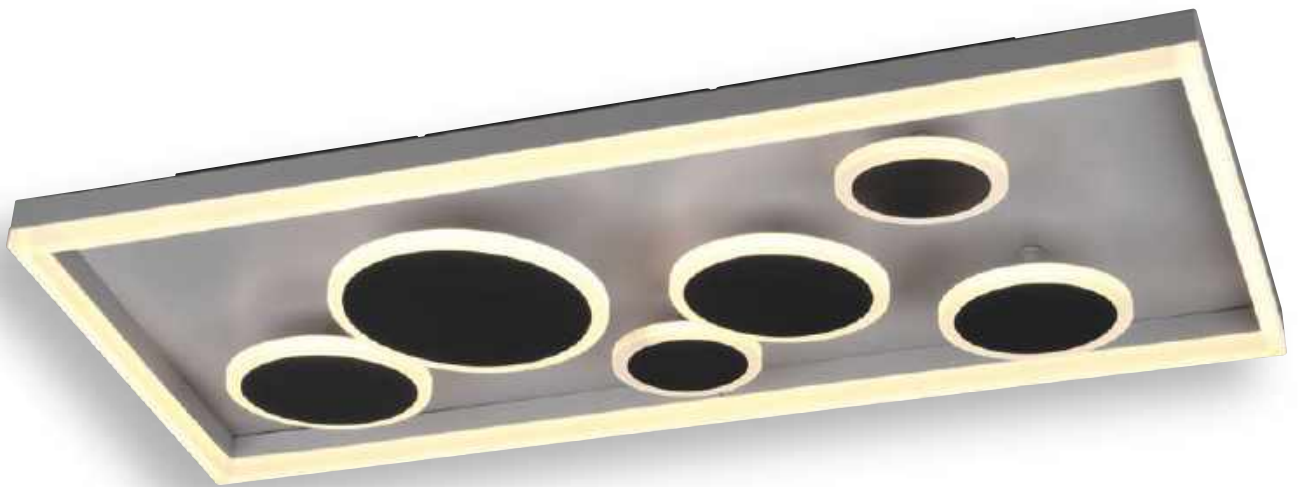

SwitchDimtoWarm

Einstellung der Helligkeit und der Lichtfarbe mit herkömmlichem Lichtschalter · Setting the brightness and light color with a conventional light switch · Réglage de la luminosité et de la couleur de la lumière avec un interrupteur conventionnel · Instelling van de felheid en lichtkleur met een gewone lichtschakelaar · Regulación de la claridad y del color de la luz mediante un interruptor de la luz convencional · Regolazione del colore e della luminosità della luce con un interruttore di tipo convenzionale · Reglarea luminozității și a culorii luminii prin intermediul unui întrerupător de lumină uzual · Kirkkauden ja valon värin säätäminen tavallisilla valokytkimillä · Regulacja jasności i barwy światła za pomocą konwencjonalnego włącznika światła



↔ 60 x 60 cm, ↑ 9,2 cm
incl. SMD-LED, 45 W
3.800 lm, 2.500 + 3.500 K



671710442
671710479

↔ 80 x 40 cm, ↑ 9,2 cm
incl. SMD-LED, 45 W
3.800 lm, 2.500 + 3.500 K



671710742
671710779



42 Anthrazit / Grau · anthracite / grey
79 goldfarbig / Braun · gold / brown



HARRIET

Metall, goldfarbig / Braun oder Anthrazit / Grau · metal, gold / brown or anthracite / grey ·
metale, or / brun ou antracite / gris · metaal, goud / bruin of antraciet / grijs ·
metal, oro / marron o antracita / gris · metallo, oro / marrone o antracite / grigio ·
metal, aur / maro sau antracit / gri · metalli, kultaa / ruskea tai antrasiitti / harmaa ·
metal, złota / brązowy lub antracyt / popielaty





SUBARA

Metall Weiß matt, Acryl · metal white mat, acryl ·
metale blanc mat, acryl · metaal wit mat, acryl ·
metal estera blanca, acrílico · metallo bianco opaco, acrilico ·
metal alb mat, acrylic · metalli valkoinen matto, akryyli · metal biały mat, akryl



LED SWITCHDIMMER



↔ 40 x 26 cm, ↑ 5,6 cm
incl. SMD-LED, 20 W
2.100 lm, 3.000 + 4.000 K



274510107



↔ 88 x 58 cm, ↑ 6,4 cm
incl. SMD-LED, 58 W
5.400 lm, 3.000 - 5.500 K



674510107







SUZUKA

Metall Weiß matt, Acryl · metal white mat, acryl ·
 metale blanc mat, acryl · metaal wit mat, acryl ·
 metal estera blanca, acrílico · metallo bianco opaco, acrilico ·
 metal alb mat, acrilic · metalli valkoinen matto, akryyli · metal biały mat, akryl



↔ 55 x 55 cm, ↑ 6,5 cm
 incl. SMD-LED, max. 40 W
 max. 3.800 lm, 3.000 - 5.500 K



675010101

↔ 98 x 68 cm, ↑ 6,5 cm
 incl. SMD-LED, max. 75 W
 max. 7.000 lm, 3.000 - 5.500 K



675090101







TRINITY

Aluminium gebürstet, Acryl · brushed aluminium, acryl ·
aluminium balayé, acryl · geborsteld aluminium, acryl · aluminio pulido, acrílico ·
alluminio spazzolato, acrilico · aluminiu lucios, acrilic · harjattu alumiini, akryyli ·
aluminium szczotkowane, akryl



3.000 K



4.000 K



5.500 K



↑ 30 x 20 cm, ↗ 7 cm
incl. SMD-LED, 10 W
800 lm, 3.000+4.000+5.500 K



274813005



↔ 40 x 40 cm, ↓ 7 cm
incl. SMD-LED, 24 W
2.000 lm, 3.000+4.000+5.500 K



674814005



↔ 60 x 60 cm, ↓ 7 cm
incl. SMD-LED, 45 W
4.000 lm, 3.000 - 5.500 K



674816005





GALE

Metall, Nickel matt, Weiß matt oder Schwarz matt · metal, nickel mat, white mat or black mat ·
 metale, nickel mat, blanc mat ou noir mat · metaal, nikkel mat, wit mat of mat zwart ·
 metal, níquel mate, estera blanca o estera negra · metallo, nichel opaco, bianco opaco o nero opaco ·
 metal, nichel mat, alb mat sau negru mat · metalli, harjattu teräs, mattavalkoinen tai mattamusta ·
 metal, nikiel mat, biały mat lub czarny mat

LED SWITCHDIMMER



↔ 60 x 43 cm, ↑ 13,5 cm
 incl. SMD-LED, 38,5 W
 3.850 lm, 3.000 K

↔ 80 x 65 cm, ↑ 14,5 cm
 incl. SMD-LED, 50 W
 5.250 lm, 3.000 K



673916007
673916031
673916032

673918007
673918031
673918032



07 Nickel matt · nickel mat
31 Weiß matt · white mat
32 Schwarz matt · black mat





31

SEDONA

Aluminium gebürstet oder Weiß matt · brushed aluminium or white mat · aluminium balayé ou blanc mat · geborsteld aluminium of wit mat · aluminio pulido o estera blanca · alluminio spazzolato o bianco opaco · aluminiumu lucios sau alb mat · harjattu alumiini tai valkoinen matto · aluminium szczotkowane lub biały mat

LED SWITCHDIMMER



350



Ø 60 cm, ↑ 6 cm
incl. SMD-LED, 30 W
2.800 lm, 3.000 K



673210206
673210231



Ø 80 cm, ↑ 8 cm
incl. SMD-LED, 40 W
3.600 lm, 3.000 K



673210306
673210331



06 Chrom · chrome
31 Weiß matt · white mat

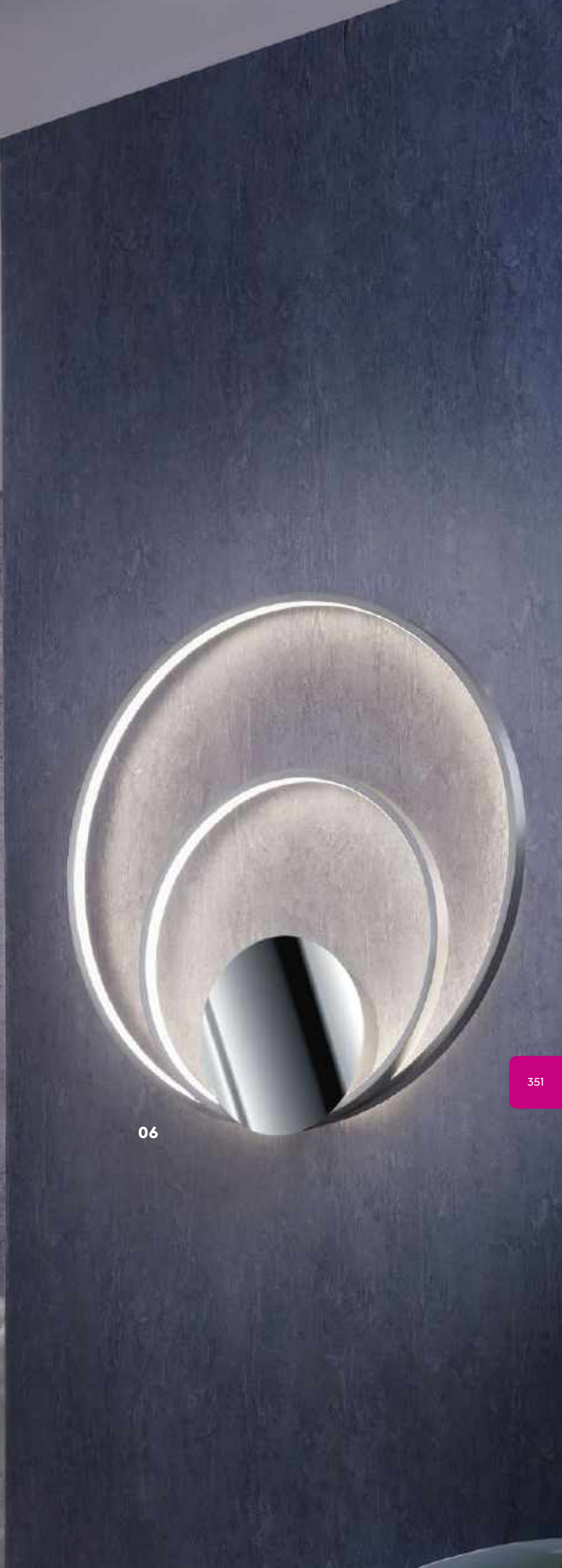

06



TUCSON

Schwarz matt, Holznachbildung · black mat, wood imitation ·
noir mat, imitation bois · mat zwart, houtimitatie ·
estera negra, imitación de madera · nero opaco, effetto legno ·
negru mat, imitație de lemn · mattamusta, puujäljitelmä ·
czarny mat, imitacja drewna

LED SWITCHDIMMER

352

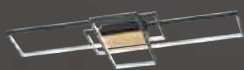

↔ 104 x 42 cm, ↓ 9 cm
incl. SMD-LED, 35 W
3.300 lm, 3.000 K



672610332



SEDONA

Schwarz matt, Holznachbildung · black mat, wood imitation ·
noir mat, imitation bois · mat zwart, houtimitatie ·
estera negra, imitación de madera · nero opaco, effetto legno ·
negru mat, imitație de lemn · mattamusta, puujäljitelmä ·
czarny mat, imitacja drewna

LED SWITCHDIMMER



Ø 80 cm, ↓ 9 cm
incl. SMD-LED, 40 W
3.600 lm, 3.000 K



673210332



IRVINE

Metall, Nickel matt, Weiß matt oder Anthrazit · metal, nickel mat, white mat or anthracite ·
 metale, nickel mat, blanc mat ou antracite · metaal, nikkel mat, wit mat of antraciet ·
 metal, níquel mate, estera blanca o antracita · metallo, nichel opaco, bianco opaco o antracite ·
 metal, nichel mat, alb mat sau antracit · metalli, harjattu teräs, mattavalkoinen tai antrasiitti ·
 metal, nikiel mat, biały mat lub antracyt



↔ 105 x 42 cm, ↑ 6,5 cm
 incl. SMD-LED, 60 W
 6.500 lm, 3.000-6.500 K



620010407
620010431
620010442



07 Nickel matt · nickel mat
31 Weiß matt · white mat
42 Anthrazit · anthracite



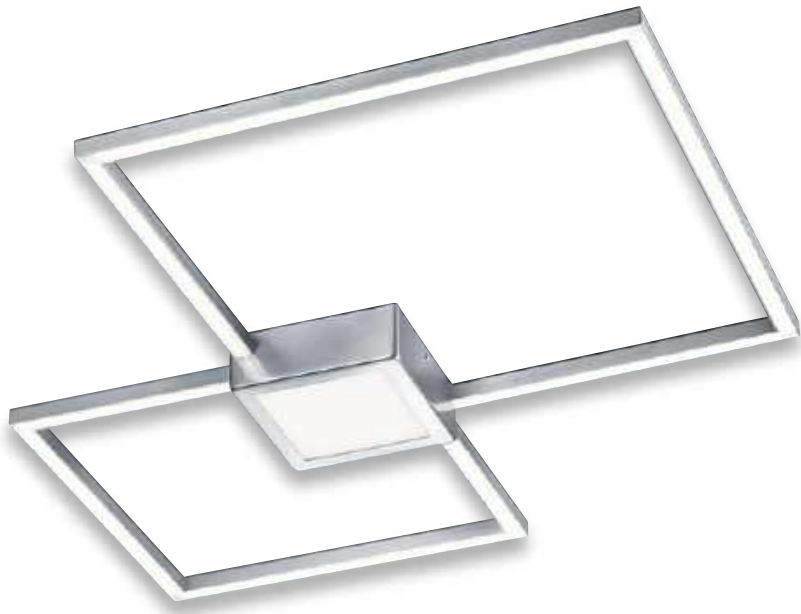

HYDRA

Nickel matt oder Anthrazit · nickel mat or anthracite ·
 nickel mat ou antracite · nikkell mat of antraciet · níquel mate o antracita ·
 nichel opaco o antracite · nichel mat sau antracit · harjattu teräs tai antrasiitti ·
 nikiel mat lub antracyt

LED SWITCHDIMMER

356



↔ 65 x 65 cm, ↑ 5 cm
 incl. SMD-LED, 28 W
 2.600 lm, 3.000 K



676210307
 676210342

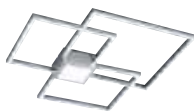

↔ 65,5 x 66,5 cm, ↑ 6,5 cm
 incl. SMD-LED, 38 W
 4.000 lm, 3.000 K



676210407
 676210442



↔ 80,5 x 45 cm, ↑ 5 cm
 incl. SMD-LED, 28 W
 2.600 lm, 3.000 K



676290307



07 Nickel matt · nickel mat
 42 Anthrazit · anthracite



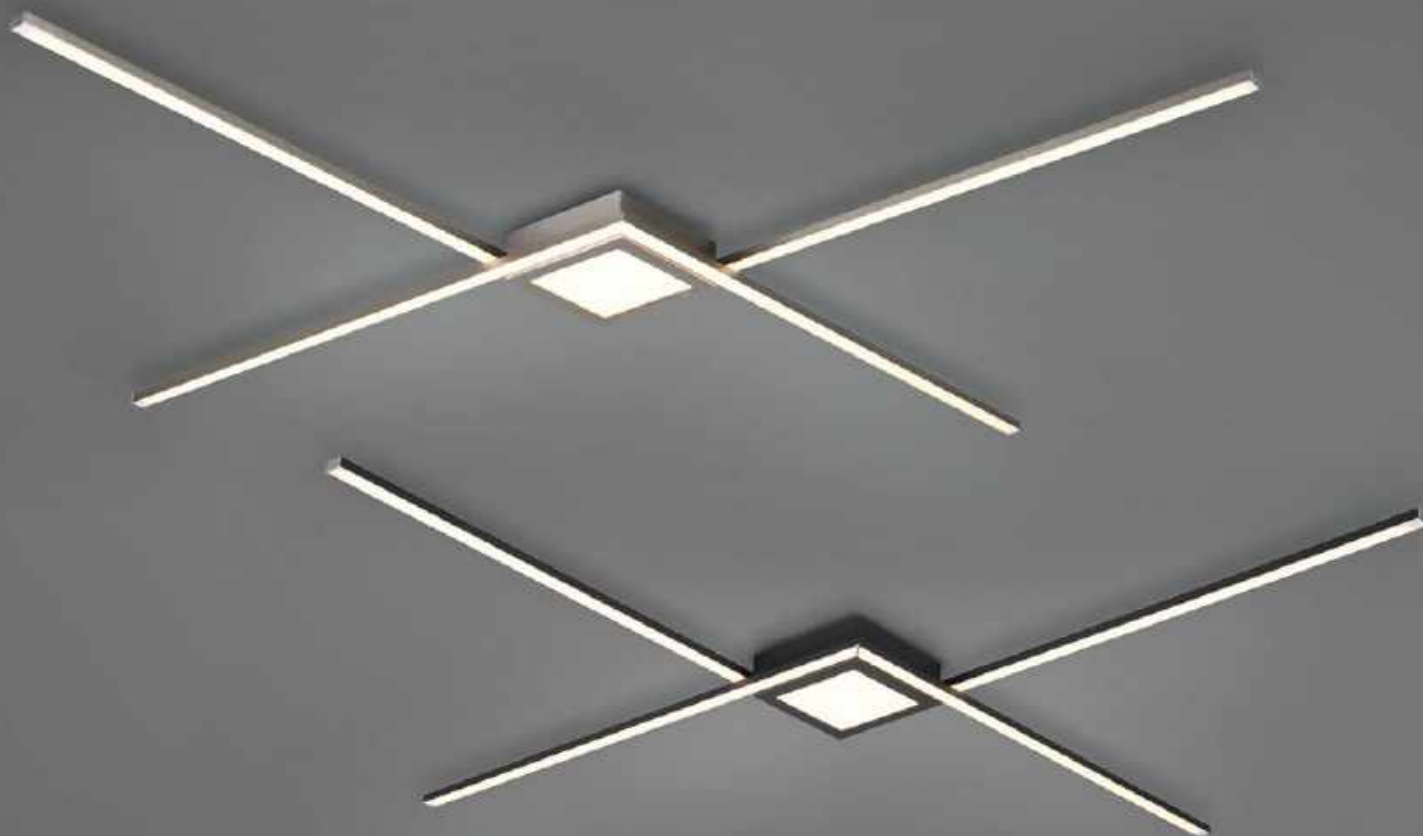

OXFORD

Metall, Nickel matt, Weiß matt oder Anthrazit · metal, nickel mat, white mat or anthracite ·
 metale, nickel mat, blanc mat ou antracite · metaal, nikkell mat, wit mat of antraciet ·
 metal, níquel mate, estera blanca o antracita · metallo, nichel opaco, bianco opaco o antracite ·
 metal, nichel mat, alb mat sau antracit · metalli, harjattu teräs, mattavalkoinen tai antrasiitti ·
 metal, nikiel mat, biały mat lub antracyt

LED SWITCHDIMMER



↔ 102 x 78 cm, ↑ 5 cm
 incl. SMD-LED, 27 W
 3.000 lm, 3.000 K



674410307
 674410342



↔ 102 x 78 cm, ↑ 5 cm
 incl. SMD-LED, 27 W
 3.300 lm, 4.000 K



674410331



07 Nickel matt · nickel mat
31 Weiß matt · white mat
42 Anthrazit · anthracite



4.000 Kelvin





INDIRA

Metall, Nickel matt oder Weiß matt, Acryl · metal, nickel mat or white mat, acryl ·
 metale, nickel mat ou blanc mat, acryl · metaal, nikkell mat of wit mat, acryl ·
 metal, níquel mate o estera blanca, acrílico · metallo, nichel opaco o bianco opaco, acrílico ·
 metal, nichel mat sau alb mat, acrilic · metalli, harjattu teräs tai mattavalkoinen, akryyli ·
 metal, nikiel mat lub biały mat, akryl

Gibt Licht nach oben und unten · up and down lighting ·
 point lumineux en haut et en bas · lichtpunt boven en onder · luz de arriba y abajo ·
 luce su e giù · sus și în jos lumina · ylös ja alas valoa · w górę i w dół światło

LED SWITCHDIMMER



↔ max. 245 cm, ↑ 6,5 cm
 incl. SMD-LED, 3 x 6 W
 3 x 650 lm, 3.000 K
 incl. SMD-LED, 2 x 3,5 W
 2 x 350 lm, 3.000 K



674610507



↔ max. 245 cm, ↑ 6,5 cm
 incl. SMD-LED, 3 x 6 W
 3 x 720 lm, 4.000 K
 incl. SMD-LED, 2 x 3,5 W
 2 x 420 lm, 4.000 K



674610531



↔ max. 345 cm, ↑ 6,5 cm
 incl. SMD-LED, 20 W
 2.150 lm, 3.000 K
 incl. SMD-LED, 8 W
 850 lm, 3.000 K



674610707



↔ max. 345 cm, ↑ 6,5 cm
 incl. SMD-LED, 20 W
 2400 lm, 4.000 K
 incl. SMD-LED, 8 W
 960 lm, 4.000 K



674610731



07 Nickel matt · nickel mat
 31 Weiß matt · white mat



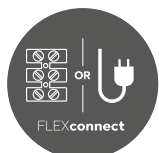
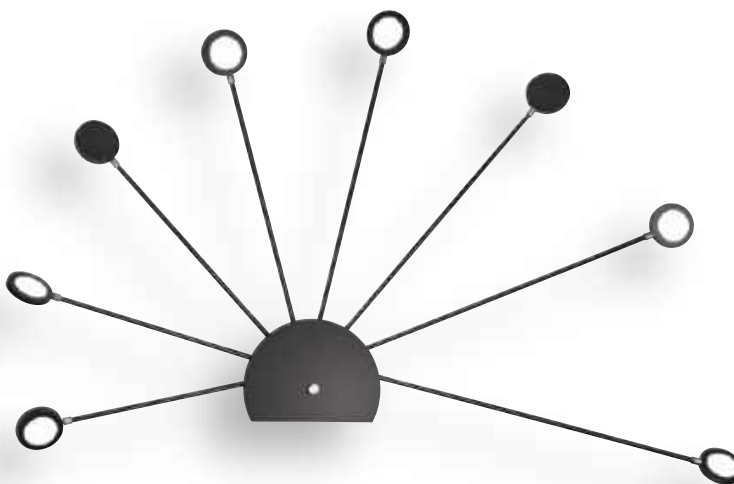
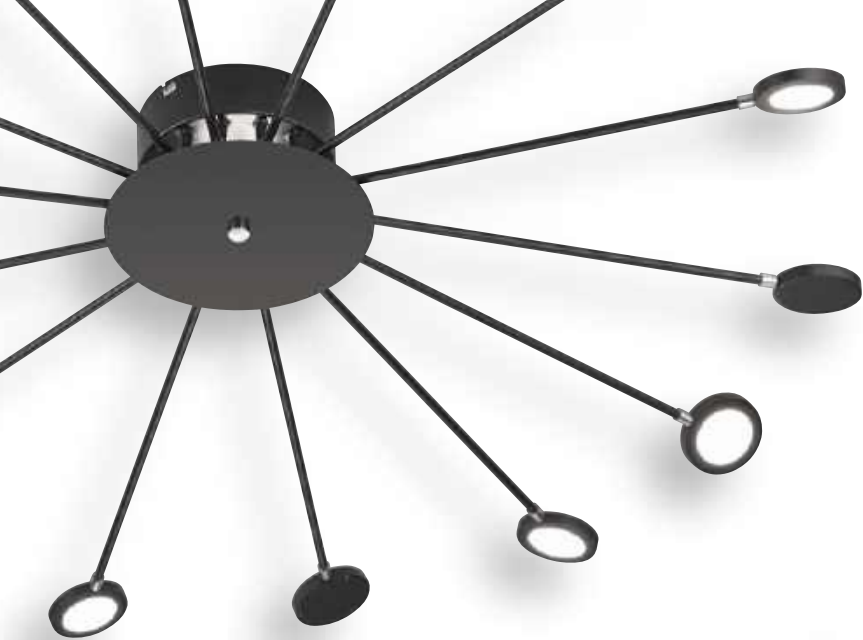

Seite/page 685

PEACOCK

Metall, Weiß matt oder Schwarz matt · metal, white mat or black mat ·
 metale, blanc mat ou noir mat · metaal, wit mat of mat zwart · metal, estera blanca o estera negra ·
 metallo, bianco opaco o nero opaco · metal, alb mat sau negru mat · metalli, valkoinen matto tai musta matto ·
 metal, biały mat lub czarny mat

LED SWITCHDIMMER

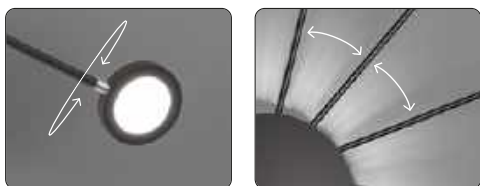

362



↔ 104 x 60,5 cm, ↗ 11 cm
 incl. 9 x SMD-LED, 2,6 W
 9 x 270 lm, 4.000 K

↔ 104 x 60,5 cm, ↗ 11 cm
 incl. 9 x SMD-LED, 2,6 W
 9 x 260 lm, 3.000 K

↔ 115 x 97,5 cm, ↑ 10,5 cm
 incl. 15 x SMD-LED, 2,6 W
 15 x 270 lm, 4.000 K

↔ 115 x 97,5 cm, ↑ 10,5 cm
 incl. 15 x SMD-LED, 2,6 W
 15 x 260 lm, 3.000 K



279570931



279570932



679511531



679511532



31 Weiß matt · white mat
32 Schwarz matt · black mat





BODRUM

Chrom · chrome ·
chrome · chroom · cromo · cromo ·
crom · kromi · chrom · krom



Ø 65 cm, ↑ 8 cm
incl. 10 x SMD-LED, 2,1 W
10 x 200 lm, 3.000 - 6.500 K
incl. 1 x SMD-LED, 6,6 W
570 lm, 3.000 - 6.500 K



673311106



Ø 100 cm, ↑ 8,5 cm
incl. 12 x SMD-LED, 2,1 W
12 x 200 lm, 3.000 - 6.500 K
incl. 1 x SMD-LED, 6,6 W
570 lm, 3.000 - 6.500 K



673311306





GRANADA

Chrom, Weiß matt oder Schwarz matt, goldfarbig · chrome white mat, or black mat, gold ·
chrome blanc mat, ou noir mat, or · chroom wit mat, of mat zwart, goud ·
cromo estera blanca, o estera negra, oro · cromo bianco opaco, o nero opaco, oro ·
chrom alb mat, sau negru mat, aur · kromi mattavalkoinen, tai mattamusta, kultaa ·
chrom biały mat, lub czarny mat, złota

LED SWITCHDIMMER



↔ 59 x 43 cm, ↑ 8,5 cm
incl. SMD-LED, 29 W
2.650 lm, 3.000 K



673810206
673810232



↔ 85 x 60 cm, ↑ 8,5 cm
incl. SMD-LED, 36 W
3.250 lm, 3.000 K



673890206
673890232



06 Chrom · chrome
32 Schwarz matt · black mat





DOLPHIN

Nickel matt oder goldfarbig · nickel mat or gold ·
nickel mat ou or · nikkell mat of goud · níquel mate o oro ·
nichel opaco o oro · nichel mat sau aur · harjattu teräs tai kultaa ·
nikiel mat lub złota

LED SWITCHDIMMER

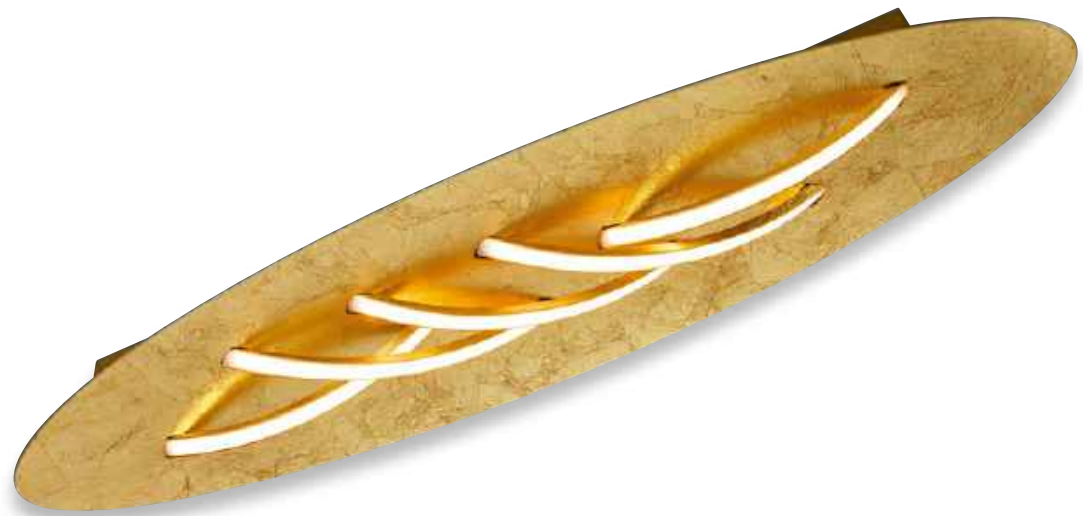

↔ 55 x 18 cm, ↑ 8,5 cm
incl. 3 x SMD, 3,6 W
3 x 380 lm, 3.000 K



677010307
677010379

↔ 85 x 20 cm, ↑ 8,5 cm
incl. 5 x SMD, 3,6 W
5 x 380 lm, 3.000 K



677010507
677010579

Ø 45 cm, ↑ 8,5 cm
incl. 6 x SMD, 3,6 W
6 x 380 lm, 3.000 K



677010607
677010679



07 Nickel matt · nickel mat
79 goldfarbig · gold

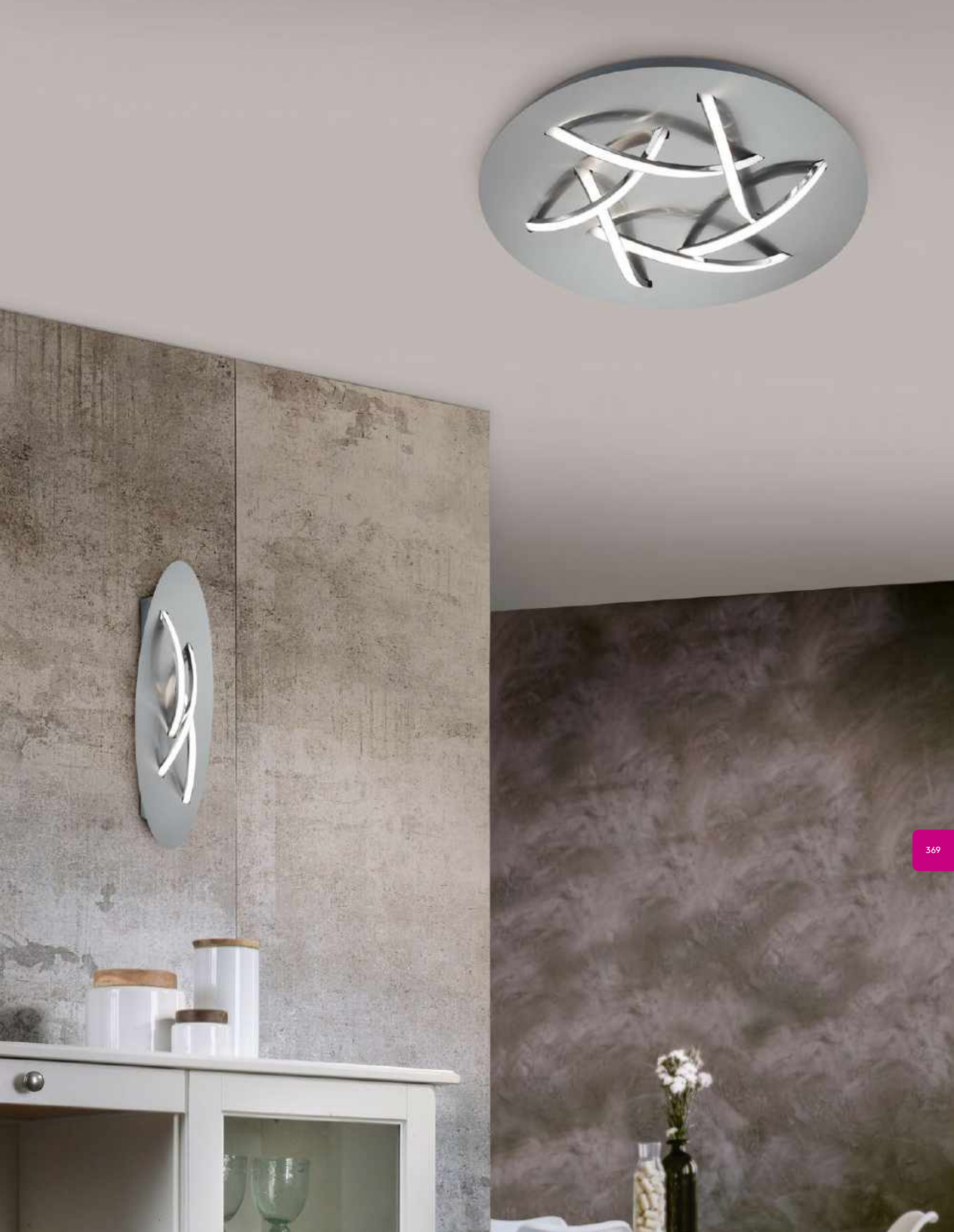



↔ 50 x 50 cm, ↑ 4,5 cm
incl. SMD-LED, 22 W
2.100 lm, 3.000 - 6.000 K



676615031

↔ 75 x 75 cm, ↑ 4,5 cm
incl. SMD-LED, 36 W
3.300 lm, 3.000 - 6.000 K



676617531

↔ 110 x 60 cm, ↑ 4,5 cm
incl. SMD-LED, 48 W
4.300 lm, 3.000 - 6.000 K



676611031



TITUS

Metall, Weiß matt · metal, white mat ·
metale, blanc mat · metaal, wit mat · metal, estera blanca ·
metallo, bianco opaco · metal, alb mat · metalli, valkoinen matto ·
metal, biały mat





TORRANCE

Metall, titanfarbig, Acryl · metal, titan, acryl ·
 metale, titane, acryl · metaal, titaan, acryl · metal, titán, acrílico ·
 metallo, titano, acrilico · metal, titaniu, acrilic · metalli, titaani, akryyli ·
 metal, tytanowy, akryl



↔ 64 x 44 cm, ↑ 6,2 cm
 incl. SMD-LED, 32 W
 3.200 lm, 2.700 - 6.500 K



674110687



↔ 80 x 52 cm, ↑ 6,2 cm
 incl. SMD-LED, 45 W
 5.000 lm, 2.700 - 6.500 K



674110887



↔ 110 x 70 cm, ↑ 6,2 cm
 incl. SMD-LED, 55 W
 6.000 lm, 2.700 - 6.500 K



674111187



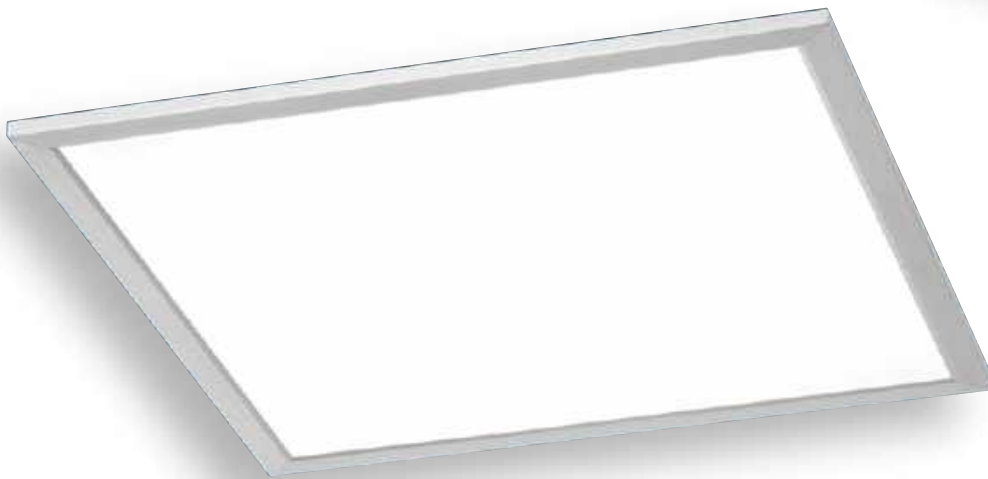

PHOENIX

Nickel matt, Acryl · nickel mat, acryl ·
nickel mat, acryl · nikkell mat, acryl · níquel mate, acrílico · nichel opaco, acrilico ·
nichel mat, acrilicharjattu teräs, akryyli · nikiel mat, akryl



Ø 30 cm, ↓ 4,2 cm
incl. SMD-LED, 15 W
1.500 lm, 3.000 K



674093007



Ø 45 cm, ↓ 4,2 cm
incl. SMD-LED, 25 W
2.500 lm, 3.000 K



674094507



Ø 62 cm, ↓ 4,2 cm
incl. SMD-LED, 30 W
3.000 lm, 3.000 K



674096207



↔ 30 x 30 cm, ↓ 4,2 cm
incl. SMD-LED, 15 W
1.500 lm, 3.000 K



674013007



↔ 45 x 45 cm, ↓ 4,2 cm
incl. SMD-LED, 25 W
2.500 lm, 3.000 K



674014507



↔ 62 x 62 cm, ↓ 4,2 cm
incl. SMD-LED, 30 W
3.000 lm, 3.000 K



674016207

↔ 120 x 30 cm, ↓ 4,2 cm
incl. SMD-LED, 30 W
3.000 lm, 3.000 K



674011207



LUCAS

Aluminium gebürstet, Acryl · brushed aluminium, acryl ·
aluminium balayé, acryl · geborsteld aluminium, acryl ·
aluminio pulido, acrílico · alluminio spazzolato, acrilico ·
aluminu lucios, acrilic · harjattu alumiini, akryyli ·
aluminium szczotkowane, akryl



FUTURE

Edelstahl, Acryl · steel, acryl ·
acier, acryl · staal, acryl · acero, acrílico ·
acciaio, acrilico · inox, acrilic · teräs, akryyli ·
stal, akryl

IP44



↔ 81,5 x 31,5 cm, ↓ 5 cm
incl. SMD-LED, 30 W
3.000 lm, 3.000 K



659513605



↔ 40 x 40 cm, ↓ 4,5 cm
incl. SMD-LED, 18 W
1.600 lm, 3.500 K

IP44

622714007



↔ 30 x 30 cm, ↓ 4,5 cm
incl. SMD-LED, 12 W
1.100 lm, 3.500 K

IP44

622713007



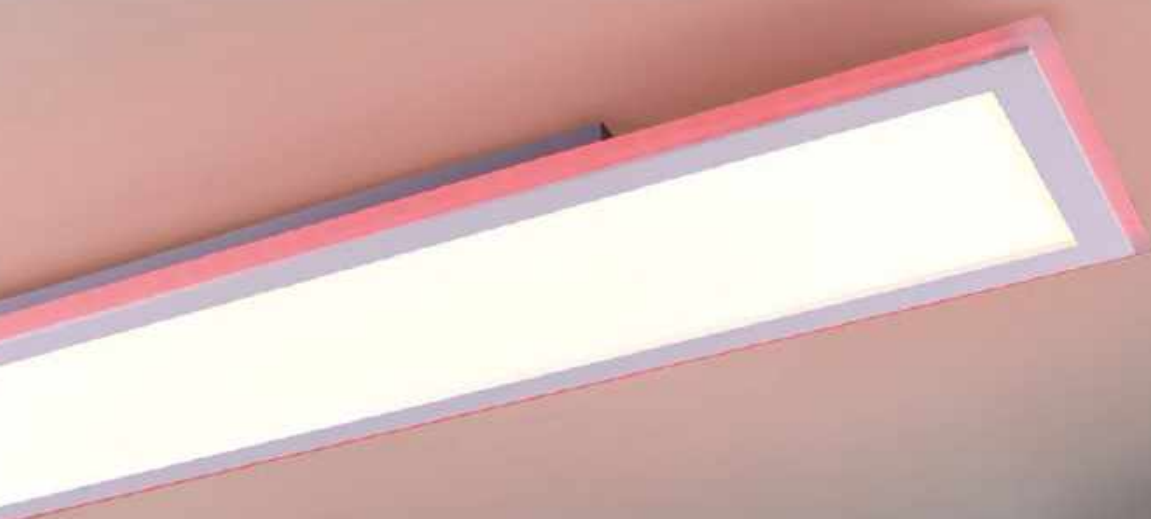

Getrennt schaltbar · Separately switchable
Interrupteurs séparés · Gescheiden schakelbaar ·
Interruptores separados · Interruttori separati ·
Intrerupatoare separate · Erikseen kytkettävissä ·
Oddzielny przełącznik



↔ 100 x 25 cm, ↑ 5,5 cm
incl. SMD-LED, 38 W
4.000 lm, 2.700 - 6.500 K



679010031

↔ 45 x 45 cm, ↑ 5,5 cm
incl. SMD-LED, 28 W
3.200 lm, 2.700 - 6.500 K



679015031

Ø 50 cm, ↑ 5,5 cm
incl. SMD-LED, 45 W
5.000 lm, 2.700 - 6.500 K



679095031



COLUMBIA

Kunststoff, Acryl · plastic, acryl ·
plastique, acryl · kunststof, acryl · plástico, acrílico ·
plastica, acrílico · plastic, acrilic · muovi, akryyli · plastik, akryl





COOKIE

Metall, Weiß matt oder Schwarz matt · metal, white mat or black mat ·
metale, blanc mat ou noir mat · metaal, wit mat of mat zwart ·
metal, estera blanca o estera negra · metallo, bianco opaco o nero opaco ·
metal, alb mat sau negru mat · metalli, valkoinen matto tai musta matto ·
metal, biały mat lub czarny mat

Empfohlen:

recommended: LED GU10, 5 W
400 lm, 3.000 K



956-5936



BISCUIT

Metall, Weiß matt oder Schwarz matt · metal, white mat or black mat ·
metale, blanc mat ou noir mat · metaal, wit mat of mat zwart ·
metal, estera blanca o estera negra · metallo, bianco opaco o nero opaco ·
metal, alb mat sau negru mat · metalli, valkoinen matto tai musta matto ·
metal, biały mat lub czarny mat



Ø 9,6 cm, ↓ 12,5 cm
excl. 1 x GU10, max. 35 W



612900131
612900132

↔ 17,8 x 9,6 cm, ↓ 12,5 cm
excl. 2 x GU10, max. 35 W



612900231
612900232

↔ 17,8 x 17,8 cm, ↓ 12,5 cm
excl. 4 x GU10, max. 35 W



612900431
612900432

↔ 9,6 x 9,6 cm, ↓ 12,5 cm
excl. 1 x GU10, max. 35 W



613000131
613000132

↔ 17,8 x 9,6 cm, ↓ 12,5 cm
excl. 2 x GU10, max. 35 W



613000231
613000232



↔ 17,8 x 17,8 cm, ↑ 12,5 cm
excl. 4 x GU10, max. 35 W



613000431
613000432



31 Weiß matt · white mat
32 Schwarz matt · black mat



FERNANDO

Metall, Weiß matt oder Schwarz matt · metal, white mat or black mat ·
 metale, blanc mat ou noir mat · metaal, wit mat of mat zwart · metal, estera blanca o estera negra ·
 metallo, bianco opaco o nero opaco · metal, alb mat sau negru mat ·
 metalli, valkoinen matto tai musta matto · metal, biały mat lub czarny mat

Empfohlen:
 recommended: LED GU10, 5 W
 400 lm, 3.000 K



956-5936

382



↔ 23 x 20 cm, ↓ 15 cm
 excl. 3 x GU10, max. 35 W



604900331
 604900332



↔ 37 x 30 cm, ↓ 15 cm
 excl. 6 x GU10, max. 35 W



604900631
 604900632



31 Weiß matt · white mat
 32 Schwarz matt · black mat





geeignet für Auf- und Einbau · suitable for both mounting and installation ·
 adapté au montage et à l'installation · geschikt voor in en opbouw ·
 apropiadas tanto para montaje como para instalación · ideale sia per
 montaggio e installazione · adecvate pentru aplicare și încorporare ·
 sopii pinta- ja upposennukseen · odpowiednie zarówno do montażu
 jak i instalacji

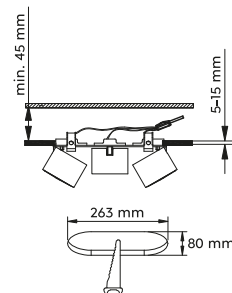
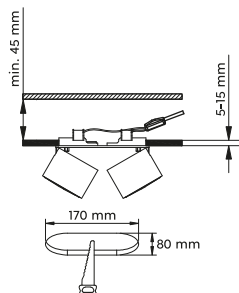
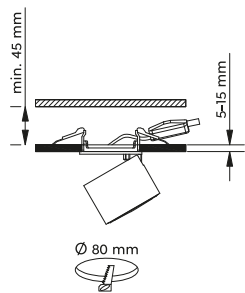

Ø 9 cm, 11 cm
 incl. SMD-LED, 3,5 W
 340 lm, 3.000 K
 incl. SMD-LED, 1,5 W
 110 lm, 3.000 K



652910131
 652910132

↔ 18 x 9 cm, ↓ 11 cm
 incl. 2 x SMD-LED, 3,5 W
 2 x 340 lm, 3.000 K
 incl. 2 x SMD-LED, 1,5 W
 2 x 110 lm, 3.000 K



652910231
 652910232

↔ 27 x 9 cm, ↓ 11 cm
 incl. 3 x SMD-LED, 3,5 W
 3 x 340 lm, 3.000 K
 incl. 3 x SMD-LED, 1,5 W
 3 x 110 lm, 3.000 K



652910331
 652910332



31 Weiß matt · white mat
 32 Schwarz matt · black mat



TAURUS

Metall, Weiß matt oder Schwarz matt · metal, white mat or black mat ·
metale, blanc mat ou noir mat · metaal, wit mat of mat zwart ·
metal, estera blanca o estera negra · metallo, bianco opaco o nero opaco ·
metal, alb mat sau negru mat · metalli, valkoinen matto tai musta matto ·
metal, biały mat lub czarny mat



385



1x

2x

3x



Getrennt schaltbar · Separately switchable
Interrupteurs séparés · Gescheiden schakelbaar ·
Interruptores separados · Interruttori separati ·
Intrerupatoare separate · Erikseen kytkettävissä ·
Oddzileny przełącznik



CORLAND

Chrom, Aluminium gebürstet · chrome, brushed aluminium ·
 chrome, aluminium balayé · chroom, geborsteld aluminium ·
 cromo, aluminio pulido · cromo, alluminio spazzolato ·
 crom, aluminiu lucios · kromi, harjattu alumiini ·
 chrom, aluminium szczotkowane



POLYDOR

Nickel matt · nickel mat ·
 nickel mat · nikkell mat · níquel mate · nichel opaco ·
 nichel mat · harjattu teräs · nikiel mat

386



↔ 48 x 40 cm, ↑ 38 cm
 incl. 1 x SMD-LED, 24 W
 2.160 lm, 3.000 K

∅ 56 cm, ↑ 26 cm
 incl. 4 x SMD-LED, 6 W
 4 x 600 lm, 3.000 K



674312406



672710407



RUBY

Metall Weiß matt · metal white mat ·
metale blanc mat · metaal wit mat · metal estera blanca · metallo bianco opaco ·
metal alb mat · metalli valkoinen matto · metal biały mat



↔ 35 x 35 cm, ↑ 11 cm
incl. SMD-LED, 18 W
1.800 lm, 3.000 K



623810431



TURNER

Chrom, Acryl · chrome, acryl ·
chrome, acryl · chroom, acryl · cromo, acrílico ·
cromo, acrílico · crom, acrílic · kromi, akryyli ·
chrom, akryl



388



Ø 45 cm, ↓ 15 cm
incl. 3 x SMD-LED, 4,2 W
3 x 400 lm, 3.000 K



624410306

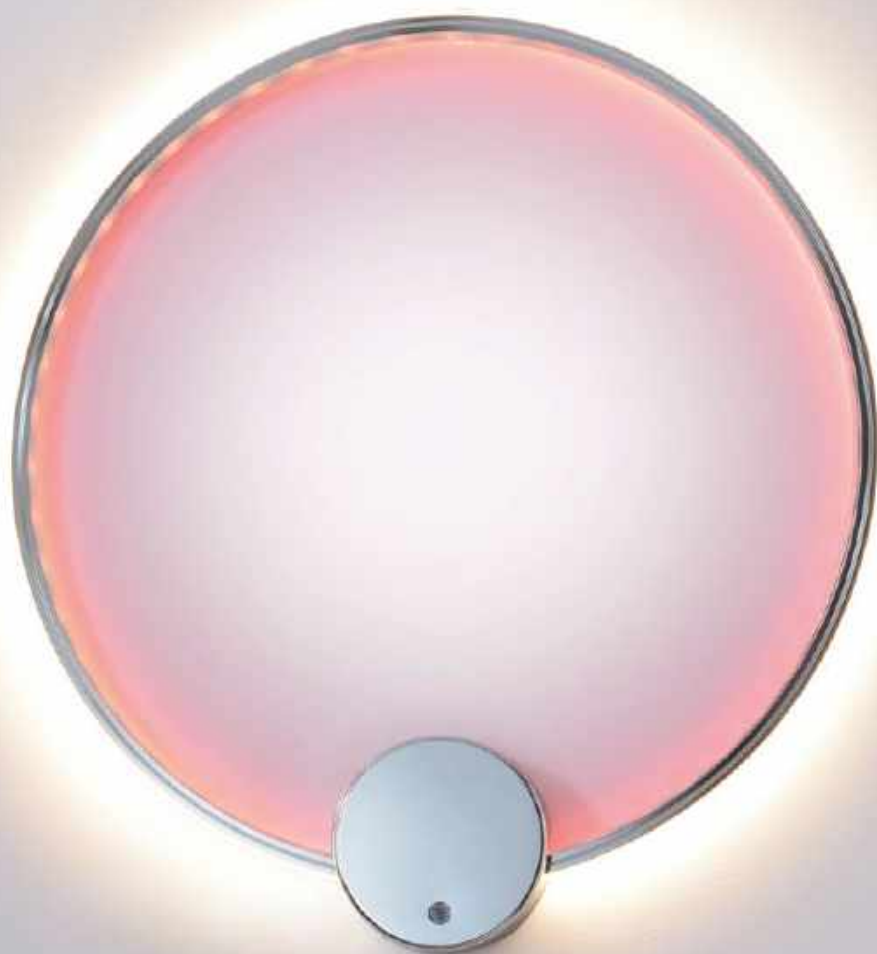

DRAGON

Chrom, Acryl · chrome, acryl ·
chrome, acryl · chroom, acryl · cromo, acrílico · cromo, acrilico ·
crom, acrylic · kromi, akryyli · chrom, akryl



Ø 69,5 cm, ↓ 4,5 cm
incl. SMD-LED, 30 W
2.500 lm, 3.000 K
incl. RGB-SMD, 15 W
1.300 lm



620210206



OGASAKI

Acryl, Starlight-Effekt · acryl, starlight effect ·
 acryl, effet étoile · acryl, sterlicht effect · acrílico, efecto de la luz · acrilico, effetto di stelle ·
 acrilic, efect lumina stelelor · akryyli, starlight vaikutus · akryl, efekt starlight



↔ 42,5 x 42,5 cm, ↑ 6,5 cm
 incl. SMD-LED, 26 W
 2.400 lm, 2.700 - 5.500 K



675710200

↔ 52,5 x 52,5 cm, ↑ 6,5 cm
 incl. SMD-LED, 42 W
 4.000 lm, 2.700 - 5.500 K



675719200

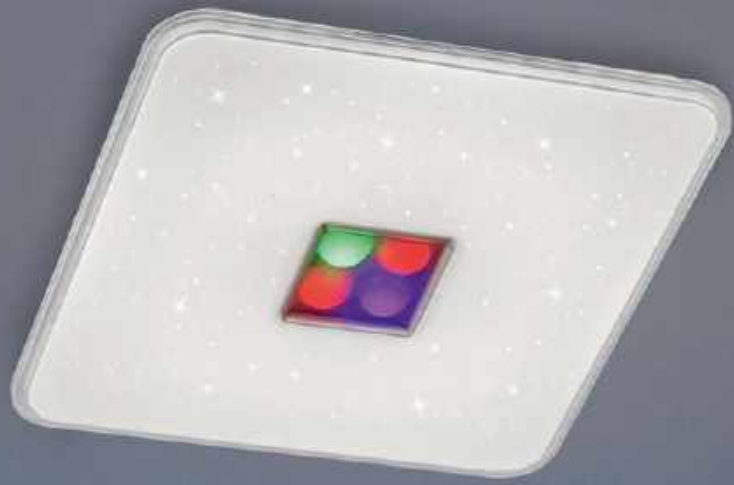



NINJA

Acryl, Chrom, Starlight-Effekt · acryl, chrome, starlight effect ·
acryl, chrome, effet étoile · acryl, chrom, Sterreneffect · acrílico, cromo, efecto de la luz ·
acrilico, cromo, effetto di stelle · acrylic, crom, efect lumina stelelor ·
akryyli, kromi, Tähtitaivas efekti · akryl, chrom, efekt starlight



Getrennt schaltbar · Separately switchable
Interrupteurs séparés · Gescheiden schakelbaar · Interruptores separados · Interruttori separati ·
Intrerupatoare separate · Erikseen kytkettävissä · Oddzileny przełącznik



Ø 60 cm, ↑ 8 cm
incl. SMD-LED, 53 W
5.000 lm, 3.000 - 5.500 K



679710506

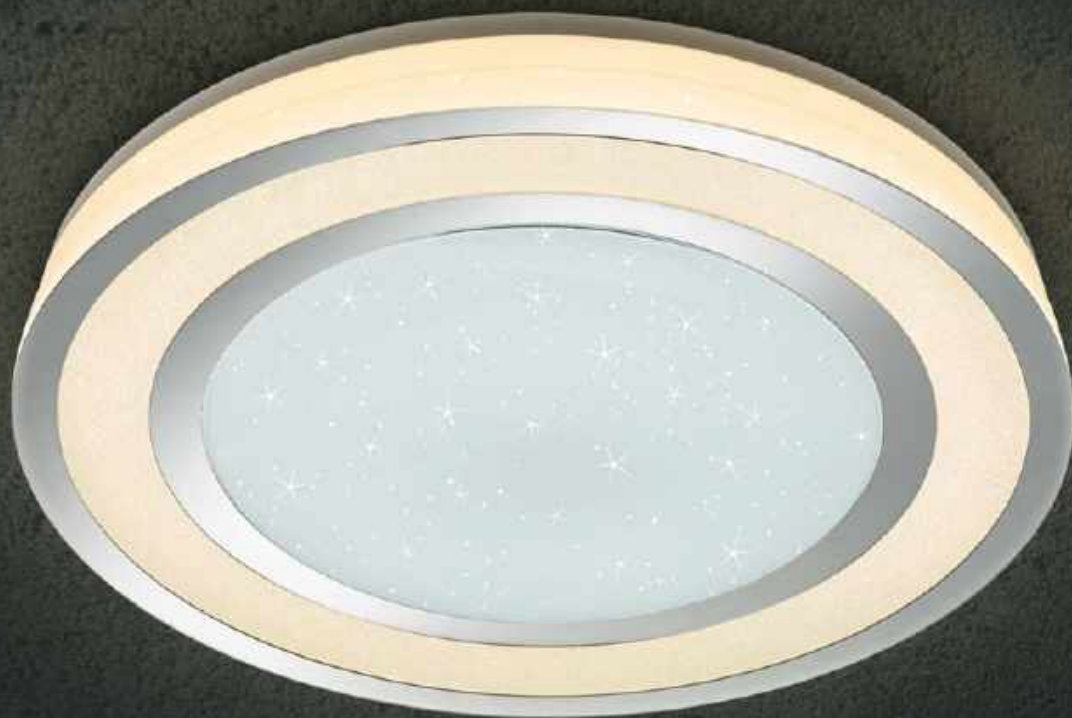

NORIAKI

Chrom, Acryl, Starlight-Effekt · chrome, acryl, starlight effect ·
chrome, acryl, effet étoile · chroom, acryl, sterlicht effect ·
cromo, acrílico, efecto de la luz · cromo, acrilico, effetto di stelle ·
crom, acrilic, efect lumina stelelor · kromi, akryyli, starlight vaikutus ·
chrom, akryl, efekt starlight · krom, akrilik, starlight etkisi



Getrennt schaltbar · Separately switchable
Interrupteurs séparés · Gescheiden schakelbaar · Interruptores separados · Interruttori separati ·
Intreruptoare separate · Erikseen kytkettävissä · Oddzileny przełącznik



Ø 59,5 cm, ↓ 10 cm
incl. SMD-LED, 45 W
4.000 lm, 3.000-5.500 K



679210106

LOTUS

Acryl, Weiß, Chrom · acryl, white, chrome ·
acryl, blanc, chrome · acryl, wit, chrom ·
acrílico, blanco, cromo · acrilico, bianco, cromo ·
acrilic, alb, crom · akryyli, valkoinen, kromi ·
akryl, biały, chrom



SHAOLIN

Acryl · acryl ·
acryl · acryl · acrílico · acrilico ·
acrilic · akryyli · akryl



Ø 60 cm, ↑ 7,5 cm
incl. SMD-LED, max. 45 W
4.000 lm, 3.000 - 5.500 K



629010101

Ø 45 cm, ↑ 5,5 cm
incl. SMD-LED, 30 W
max. 2.500 lm, 3.000 - 5.500 K



628313001

85 cm



MIKO

Chrom, Acryl, Starlight-Effekt · chrome, acryl, starlight effect ·
chrome, acryl, effet étoile · chroom, acryl, sterlicht effect ·
cromo, acrílico, efecto de la luz · cromo, acrilico, effetto di stelle ·
crom, acrilic, efect lumina stelelor · kromi, akryyli, starlight vaikutus ·
chrom, akryl, efekt starlight · krom, akrilik, starlight etkisi



395



Ø 85 cm, ↓ 12,5 cm
incl. SMD-LED, 95 W
9.600 lm, 3.000 - 5.500 K



675610106



SAPPORO

Acryl, Starlight-Effekt · acryl, starlight effect ·
acryl, effet étoile · acryl, sterlicht effect ·
acrílico, efecto de la luz · acrilico, effetto di stelle ·
acrilic, efect lumina stelelor · akryyli, starlight vaikutus ·
akryl, efekt starlight



396



↔ 41,5 x 41,5 cm, ↑ 7,5 cm
incl. SMD-LED, max. 30 W
max. 2.100 lm, 3.000 - 5.500 K



677610106

↔ 51,5 x 51,5 cm, ↑ 8,5 cm
incl. SMD-LED, max. 60 W
max. 4.500 lm, 3.000 - 5.500 K



677690106



LED SWITCHDIMMER

OSAKA

Chrom, Acryl, Starlight-Effekt · chrome, acryl, starlight effect ·
chrome, acryl, effet étoile · chrom, acryl, sterlicht effect ·
cromo, acrílico, efecto de la luz · cromo, acrílico, effetto di stelle ·
crom, acrílic, efect lumina stelelor · kromi, akryyli, starlight vaikutus ·
chrom, akryl, efekt starlight



Ø 67 cm, ↑ 10 cm
incl. SMD-LED, max. 100 W
max. 9.800 lm, 3.000 - 5.500 K



678710006



Ø 42 cm, ↑ 7 cm
incl. SMD-LED, max. 30 W
max. 3.100 lm, 3.000 - 5.500 K



678713006



Ø 21 cm, ↑ 5 cm
incl. SMD-LED, max. 12 W
max. 1.050 lm, 3.000 K



678711206



LED SWITCHDIMMER

OKINAWA

Acryl, Schwarz matt · acryl, black mat ·
acryl, noir mat · acryl, mat zwart · acrílico, estera negra ·
acrílico, nero opaco · acrilic, negru mat · akryyli, mattamusta ·
akryl, czarny mat

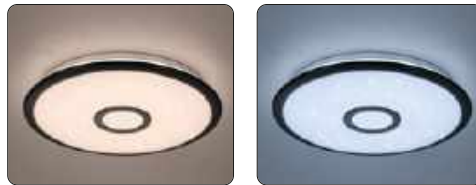

398



Ø 21 cm, ↑ 5 cm
incl. SMD-LED, 12 W
1.050 lm, 3.000 K



679112132

Ø 42 cm, ↑ 7,5 cm
incl. SMD-LED, 18 W
1.800 lm, 3.000 - 5.500 K



679114232

Ø 65 cm, ↑ 10 cm
incl. SMD-LED, 50 W
5.000 lm, 3.000 - 5.500 K



679110032





RAIKO

Acryl, Starlight-Effekt · acryl, starlight effect ·
acryl, effet étoile · acryl, sterlicht effect · acrílico, efecto de la luz ·
acrílico, effetto di stelle · acrilic, efect lumina stelelor ·
akryyli, starlight vaikutus · akryl, efekt starlight ·



SEIKO

Acryl, Starlight-Effekt · acryl, starlight effect ·
acryl, effet étoile · acryl, sterlicht effect · acrílico, efecto de la luz ·
acrílico, effetto di stelle · acrilic, efect lumina stelelor ·
akryyli, starlight vaikutus · akryl, efekt starlight ·



42,5 x 42,5 cm, ↑ 6 cm
incl. SMD-LED, 30 W
2.400 lm, 3.000-5.500 K



678613001

Ø 42,5 cm, ↑ 6 cm
incl. SMD-LED, 30 W
2.400 lm, 3.000-5.500 K



678513001

80 cm



NAGANO

Acryl, Starlight-Effekt · acryl, starlight effect ·
acryl, effet étoile · acryl, sterlicht effect · acrílico, efecto de la luz ·
acrílico, effetto di stelle · acrilic, efect lumina stelelor · akryyli, starlight vaikutus · akryl, efekt starlight



TOKYO

Acryl · acryl ·
acryl · acryl · acrílico · acrilico · acrilic · akryyli · akryl



Ø 80 cm, ↑ 10,8 cm
incl. SMD-LED, max. 80 W
max. 6.400 lm, 3.000 - 5.500 K



677718000

Ø 60 cm, ↑ 6,5 cm
incl. SMD-LED, 45 W
4.000 lm, 3.000 - 5.500 K



628915001

SHOGUN

Acryl, Starlight-Effekt · acryl, starlight effect ·
acryl, effet étoile · acryl, sterlicht effect ·
acrílico, efecto de la luz · acrilico, effetto di stelle ·
acrilic, efect lumina stelelor · akryyli, starlight vaikutus ·
akryl, efekt starlight



SAMURAI

Acryl, Starlight-Effekt · acryl, starlight effect ·
acryl, effet étoile · acryl, sterlicht effect ·
acrílico, efecto de la luz · acrilico, effetto di stelle ·
acrilic, efect lumina stelelor · akryyli, starlight vaikutus ·
akryl, efekt starlight



Ø 42,5 cm, ↑ 6 cm
incl. SMD-LED, 30 W
2.400 lm, 3.000-5.500 K



628513001

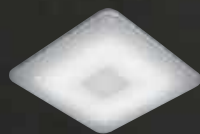

↔ 42,5 x 42,5 cm, ↑ 6 cm
incl. SMD-LED, 30 W
2.400 lm, 3.000-5.500 K



628613001



CHIBA

Acryl, Starlight-Effekt · acryl, starlight effect ·
acryl, effet étoile · acryl, sterlicht effect · acrílico, efecto de la luz ·
acrilico, effetto di stelle · acrilic, efect lumina stelelor ·
akryyli, starlight vaikutus · akryl, efekt starlight



↔ 110 x 30 cm, ↑ 7,7 cm
incl. SMD-LED, max. 60 W
max. 5.800 lm, 3.000 - 5.500 K



628898000



CONTRAST

Acryl, Starlight-Effekt · acryl, starlight effect ·
acryl, effet étoile · acryl, sterlicht effect ·
acrílico, efecto de la luz · acrilico, effetto di stelle ·
acrilic, efect lumina stelelor · akryyli, starlight vaikutus ·
akryl, efekt starlight

LED SWITCHDIMMER



CONDOR

Acryl, Starlight-Effekt · acryl, starlight effect ·
acryl, effet étoile · acryl, sterlicht effect ·
acrílico, efecto de la luz · acrilico, effetto di stelle ·
acrilic, efect lumina stelelor · akryyli, starlight vaikutus ·
akryl, efekt starlight

LED SWITCHDIMMER

404



↔ 42,5 x 42,5 cm, ↑ 9 cm
incl. SMD-LED, 21 W
2.200 lm, 4.000 K



657910100

Ø 42 cm, ↑ 9,5 cm
incl. SMD-LED, 21 W
2.200 lm, 4.000 K



657810100



LUNAR

Kunststoff · plastic ·
plastique · kunststof · plástico · plastica ·
plastic · muovi · plastik · plastik

Memory Funktion · Memory function · fonction mémoire ·
Geheugen functie · Función de memoria · Funzione memorizzazione ·
functia memorie · Muistitoiminto · Funkcja pamięci



Mondphasen individuell einstellbar · Phases of the moon individually adjustable · Phases de lune réglables · Maanstanden apart instelbaar · Fases lunares ajustables individualmente · Fasi lunari regolabili individualmente · Fazele lunii reglabile individual · Kuun vaiheet erikseen säädettävissä · Cykl księżycy indywidualnie regulowany



Ø 40 cm, ↓ 10 cm
incl. SMD-LED, 22 W
2.000 lm, 3.000 K



627514000



Ø 60 cm, ↓ 12 cm
incl. SMD-LED, 40 W
3.500 lm, 3.000 K



627516000



87



01

GONZALO

Kunststoff, Weiß oder titanfarbig · plastic, white or titan ·
plastique, blanc ou titane · kunststof, wit of titaan · plástico, blanco o titán ·
plastica, bianco o titano · plastic, alb sau titaniu · muovi, valkoinen tai titaani ·
plastik, biały lub tytanowy

406



Ø 29 cm, ↑ 8 cm
incl. SMD-LED, 9 W
750 lm, 3.000 K



626510901
626510987



Ø 34 cm, ↑ 9 cm
incl. SMD-LED, 12 W
1.050 lm, 3.000 K



626511201
626511287



Ø 42 cm, ↑ 10 cm
incl. SMD-LED, 25 W
2.000 lm, 3.000 K



626512501
626512587



01 Weiß · white
87 titanfarbig · titanium-coloured

CONVERTER

Acryl · acryl ·
acryl · acryl · acrílico · acrilico ·
acrilic · akryyli · akryl

LED AUTODIMMER



CONTENDER

Nickel matt, Acryl · nickel mat, acryl ·
nickel mat, acryl · nikkell mat, acryl ·
níquel mate, acrílico · nichel opaco, acrílico ·
nichel mat, acrilic · harjattu teräs, akryyli ·
nikiel mat, akryl

LED AUTODIMMER



100%



100-10%



FIX



OFF

Durch mehrmaliges Schalten lässt sich die Helligkeit stufenlos einstellen ·
The level of brightness can be adjusted infinitely by switching several times ·
Varier infiniment le niveau d'éclairage en utilisant l'interrupteur de manière répétée ·
Door meermaals te schakelen kan de helderheid traploos ingesteld worden ·
El brillo se puede variar infinitamente encendiendo repetidas veces ·
Il livello di luminosità, può essere regolato infinite volte ad ogni accensione ·
Nivelul de lumina poate fi ajustat infinit de mult utilizand intrerupatorul de cateva ori ·
Kirkkauden tason voi säätää useammalla painalluksella ·
Przez wielokrotne przełączanie, jasność można regulować bezstopniowo



Ø 30 cm, ↑ 9,5 cm
incl. SMD-LED, 11 W
max. 1.000 lm, 3.000 K



658311401



Ø 43 cm, ↑ 10 cm
incl. SMD-LED, 21 W
max. 2.000 lm, 3.000 K



658312601



Ø 31 cm, ↑ 9 cm
incl. SMD-LED, 11 W
max. 1.000 lm, 3.000 K



658611407



Ø 26 cm, ↑ 3 cm
incl. SMD-LED, 15 W
1.350 lm, 3.000 K



656411506

Ø 40 cm, ↑ 3 cm
incl. SMD-LED, 24 W
2.000 lm, 3.000 K



656412406

Ø 60 cm, ↑ 3 cm
incl. SMD-LED, 30 W
2.800 lm, 3.000 K



656413006



CESAR

Chrom, Acryl mit Kristalleffekt · chrome, broken glass optic ·
 chrome, optique verre pilé · chroom, Gebroken glas optiek ·
 cromo, Efecto cristal roto · cromo, effetto ottico vetro rotto ·
 crom, aspect de sticla sparta · kromi, lasi efekti optikka ·
 chrom, Optyczne rozbite szkło

LED SWITCHDIMMER

IP44



↔ 30 x 30 cm, ↓ 3 cm
 incl. SMD-LED, 18 W
 1.650 lm, 3.000 K



656511806



↔ 40 x 40 cm, ↓ 3 cm
 incl. SMD-LED, 24 W
 2.000 lm, 3.000 K



656512006



↔ 60 x 60 cm, ↓ 3 cm
 incl. SMD-LED, 30 W
 2.800 lm, 3.000 K



656513006



07

01

ZEUS

Metall, Nickel matt oder Weiß matt · metal, nickel mat or white mat ·
metale, nickel mat ou blanc mat · metaal, nikkell mat of wit mat ·
metal, níquel mate o estera blanca · metallo, nichel opaco o bianco opaco ·
metal, nichel mat sau alb mat · metalli, harjattu teräs tai mattavalkoinen ·
metal, nikiel mat lub biały mat



↔ 12 x 12 cm, ↓ 3,5 cm
incl. SMD-LED, 5,5 W
450 lm, 3.000 K

657110601
657110607



↔ 17 x 17 cm, ↓ 3,5 cm
incl. SMD-LED, 12,5 W
1.100 lm, 3.000 K

657111201
657111207



↔ 22,5 x 22,5 cm, ↓ 3,5 cm
incl. SMD-LED, 17 W
1.600 lm, 3.000 K

657111801
657111807



01 Weiß · white
07 Nickel matt · nickel mat



01

07

CENTO

Metall, Nickel matt oder Weiß matt · metal, nickel mat or white mat ·
 metale, nickel mat ou blanc mat · metaal, nikkel mat of wit mat ·
 metal, níquel mate o estera blanca · metallo, nichel opaco o bianco opaco ·
 metal, nichel mat sau alb mat · metalli, harjattu teräs tai mattavalkoinen ·
 metal, nikiel mat lub biały mat

411



Ø 12 cm, ↑ 3,5 cm
 incl. SMD-LED, 5,5 W
 450 lm, 3.000 K

657010601
 657010607



Ø 17 cm, ↑ 3,5 cm
 incl. SMD-LED, 11,5 W
 1.100 lm, 3.000 K

657011201
 657011207



Ø 22,5 cm, ↑ 3,5 cm
 incl. SMD-LED, 17 W
 1.600 lm, 3.000 K

657011801
 657011807



01 Weiß · white
07 Nickel matt · nickel mat



RHEA

Kunststoff, Weiß matt oder titanfarbig · plastic, white mat or titan ·
 plastique, blanc mat ou titane · kunststof, wit mat of titaan · plástico, estera blanca o titán ·
 plastica, bianco opaco o titano · plastic, alb mat sau titaniu · muovi, mattavalkoinen tai titaani ·
 plastik, biały mat lub tytanowy

geeignet für Auf- und Einbau · suitable for both mounting and installation ·
 adapté au montage et à l'installation · geschikt voor in en opbouw · apropiadas tanto para montaje como para instalación ·
 ideale sia per montaggio e installazione · adecvate pentru aplicare și încorporare · sopii pinta- ja uppoasennukseen ·
 odpowiednie zarówno do montażu jak i instalacji



↔ 12 x 12 cm, ↓ 3 cm
 incl. SMD-LED, 6 W
 400 lm, 3.000 K

625601231
625601287



↔ 18 x 18 cm, ↓ 3 cm
 incl. SMD-LED, 12 W
 800 lm, 3.000 K

625601831
625601887



↔ 22 x 22 cm, ↓ 3 cm
 incl. SMD-LED, 18 W
 1.200 lm, 3.000 K

625602231
625602287



31 Weiß matt · white mat
87 titanfarbig · titanium-coloured



JUNO

Kunststoff, Weiß matt oder titanfarbig · plastic, white mat or titan ·
 plastique, blanc mat ou titane · kunststof, wit mat of titaan · plástico, estera blanca o titán ·
 plastica, bianco opaco o titano · plastic, alb mat sau titaniu · muovi, mattavalkoinen tai titaani ·
 plastik, biały mat lub tytanowy

geeignet für Auf- und Einbau · suitable for both mounting and installation ·
 adapté au montage et à l'installation · geschikt voor in en opbouw · apropiadas tanto para montaje como para instalación ·
 ideale sia per montaggio e installazione · adecvate pentru aplicare și încorporare · sopii pinta- ja uppoasennukseen ·
 odpowiednie zarówno do montażu jak i instalacji



Ø 12,4 cm, ↓ 3 cm
 incl. SMD-LED, 6 W
 400 lm, 3.000 K

625501231
 625501287



Ø 18 cm, ↓ 3 cm
 incl. SMD-LED, 12 W
 800 lm, 3.000 K

625501831
 625501887



Ø 22 cm, ↓ 3 cm
 incl. SMD-LED, 18 W
 1.200 lm, 3.000 K

625502231
 625502287



31 Weiß matt · white mat
87 titanfarbig · titanium-coloured

PENTA

Dekorglas · glas decorated ·
verre décoré · decoratief glas · vidrio decorado ·
vetro decorato · sticla decorativa · ornamenttilasi ·
szkło dekoracyjne

LED SWITCHDIMMER



COMTESS

Dekorglas · glas decorated ·
verre décoré · decoratief glas · vidrio decorado ·
vetro decorato · sticla decorativa · ornamenttilasi ·
szkło dekoracyjne

LED SWITCHDIMMER



MOSAIQUE

Glas Mosaik · glass mosaic ·
verre mosaïque · glas mozaiek · vidrio mosaico ·
vetro mosaico · sticla mozaic · lasi mosaiikki ·
szkło mozaika

LED SWITCHDIMMER



Ø 40 cm, ↓ 12 cm
incl. SMD-LED, 20 W
1.800 lm, 4.000 K



656311800



Ø 40 cm, ↓ 12 cm
incl. SMD-LED, 20 W
1.800 lm, 3.000 K



656211800



Ø 40 cm, ↓ 10 cm
incl. SMD-LED, 20 W
1.800 lm, 3.000 K



673012489



1



2

GEMMA

Dekorglas · glas decorated ·
verre décoré · decoratief glas · vidrio decorado · vetro decorato ·
sticla decorativa · ornamentilasi · szkło dekoracyjne

LED SWITCHDIMMER

415



1

Ø 30 cm, ↑ 9,5 cm
incl. SMD-LED, 12 W
900 lm, 3.000 K



673611201



2

Ø 30 cm, ↑ 9,5 cm
incl. SMD-LED, 12 W
900 lm, 3.000 K



673411201



ADRIAN

Glas alabasterfarbig · alabaster-coloured glass ·
verre couleur albâtre · albastkleurig glas ·
vidrio de color alabastro · vetro colore alabastro ·
sticla culoare alabastru · lasi alabasteri väri ·
szkło alabaster kolor

416



Ø 30 cm, ↓ 9 cm
excl. 1 x E27, max. 40 W



6105011-01



Ø 40 cm, ↓ 10 cm
excl. 2 x E27, max. 40 W



6105021-01



BULTO

Nickel matt, Glas matt · nickel mat, mat glass ·
nickel mat, verre mat · nikkell mat, mat glas ·
níquel mate, vidrio mate · nichel opaco, vetro sabbiato ·
nichel mat, sticla mata · harjattu teräs, mattalasi ·
nikiel mat, szkło matowane



Ø 29 cm, ↑ 11,7 cm
excl. 1 x E27, max. 60 W



6107011-07



Ø 40 cm, ↑ 14,3 cm
excl. 2 x E27, max. 60 W



6107021-07



CURVA

Nickel matt, Glas matt · nickel mat, mat glass ·
nickel mat, verre mat · nikkell mat, mat glas · níquel mate, vidrio mate ·
nichel opaco, vetro sabbiato · nichel mat, sticla mata · harjattu teräs, mattalasi ·
nikiel mat, szkło matowane



↔ 50 x 20 cm, ↓ 27 cm
excl. 3 x E14, max. 40 W



605600307



↔ 72 x 28 cm, ↓ 27 cm
excl. 5 x E14, max. 40 W



605600507



VICTORIA

Chrom, Acryl · chrome, acryl ·
chrome, acryl · chroom, acryl · cromo, acrílico ·
cromo, acrílico · crom, acrílic · kromi, akryyli ·
chrom, akryl



DISC

Chrom, Acryl · chrome, acryl ·
chrome, acryl · chroom, acryl · cromo, acrílico ·
cromo, acrílico · crom, acrílic · kromi, akryyli ·
chrom, akryl



Ø 40 cm, ↑ 25 cm
excl. 3 x E14, max. 40 W



609700306



Ø 45 cm, ↑ 25 cm
excl. 3 x E14, max. 40 W



609000306



CORMINT

Dekorglas · glas decorated ·
verre décoré · decoratief glas · vidrio decorado ·
vetro decorato · sticla decorativa · ornamenttilasi ·
szkło dekoracyjne

420



↔ 20 x 22 cm, ↗ 8 cm
excl. 1 x E14, max. 40 W



204000106



Ø 25 cm, ↑ 7,5 cm
excl. 1 x E27, max. 40 W



604000106



Ø 30 cm, ↑ 8,5 cm
excl. 2 x E27, max. 40 W



604000206

FLORIS

Dekorglas · glas decorated ·
verre décoré · decoratief glas · vidrio decorado ·
vetro decorato · sticla decorativa · ornamenttilasi ·
szkło dekoracyjne



CARBONADO

Dekorglas · glas decorated ·
verre décoré · decoratief glas · vidrio decorado ·
vetro decorato · sticla decorativa · ornamenttilasi ·
szkło dekoracyjne



↔ 32,5 x 32,5 cm, ↑ 9 cm
excl. 2 x E27, max. 40 W



604200206



↔ 22 x 20 cm, ↗ 10 cm
excl. 1 x E14, max. 40 W



202400106



Ø 25 cm, ↑ 9,5 cm
excl. 1 x E27, max. 40 W



602400106



Ø 30 cm, ↑ 10,5 cm
excl. 2 x E27, max. 40 W



602400206



CHICO

Glas · glass ·
verre · glas · vidrio · vetro ·
sticla · lasi · szkło



BUSA

Glas satiniert · satinated glass ·
verre satiné · gesatineerd glas · vidrio satinado ·
vetro satinato · sticla satinata · satinoitu lasi ·
szkło satynowe



LANA

Glas · glass ·
verre · glas · vidrio · vetro ·
sticla · lasi · szkło



Ø 30 cm, ↑ 7,5 cm
excl. 1 x E27, max. 60 W



6160011-00



↔ 23 x 23 cm, ↑ 7,5 cm
excl. 1 x E27, max. 40 W



601400106



Ø 25 cm, ↑ 8 cm
excl. 1 x E27, max. 40 W



6196011-01
6196011-07



01 Weiß matt · white mat
07 alabasterfarbig · alabaster-coloured



NORA

Dekorglas · glas decorated ·
verre décoré · decoratief glas ·
vidrio decorado · vetro decorato ·
sticla decorativa · ornamenttilasi ·
szkło dekoracyjne



01



07

PRIMO

Metall, Glas · metal, glass ·
metale, verre · metaal, glas · metal, vidrio · metallo, vetro ·
metal, sticla · metalli, lasi · metal, szkło



Ø 25 cm, ↑ 8 cm
excl. 1 x E27, max. 40 W



602100100



Ø 30 cm, ↑ 8,5 cm
excl. 2 x E27, max. 40 W



602100200



Ø 30 cm, ↑ 7,5 cm
excl. 1 x E27, max. 60 W



6101011-01
6101011-07



01 Weiß · white
07 Nickel matt · nickel mat



QUINTA

rostfarbig, Glas alabasterfarbig · rusty, alabaster-coloured glass ·
rouille, verre couleur albâtre · roestkleur, albastkleurig glas ·
óxido, vidrio de color alabastro · ruggine, vetro colore alabastro ·
ruginiu, sticla culoare alabastru · rustiikki, lasi alabasteri väri ·
miedz, szkło alabaster kolor



RUSTICA

rostfarbig, Glas matt · rusty, mat glass ·
rouille, verre mat · roestkleur, mat glas ·
óxido, vidrio mate · ruggine, vetro sabbaiato ·
ruginiu, sticla mata · rustiikki, mattalasi ·
miedz, szkło matowane



Ø 33 cm, ↑ 20 cm
excl. 2 x E27, max. 40 W



608100224



Ø 42 cm, ↑ 32 cm
excl. 3 x E27, max. 60 W



608100324



Ø 38 cm, ↑ 14 cm
excl. 2 x E27, max. 60 W



6102021-24



REPOSA

rostfarbig antik, Glas matt · antique rust, mat glass ·
rouille antique, verre mat · roestkleur antiek, mat glas · oxido, vidrio mate ·
ruggine anticato, vetro sabbiato · ruginiu antic, sticla mata · rustiikki, mattalasi ·
antyczny rdzawy, szkło matowane

425



Ø 80 cm, ↑ 10,5 cm
incl. 15 x SMD-LED, 1 W
15 x 115 lm, 3.000 K



622811528



MOONY

Stoffschirm · fabric shade ·
abat-jour tissu · Stoffen kap · Pantalla de tela ·
paralume in tessuto · abajur textil · kangas varjostin ·
Klosz z materiału

426



Ø 25 cm, ↓ 20,5 cm
excl. 1 x E27, max. 42 W



602300101
602300145
602300194



Ø 40 cm, ↓ 20,5 cm
excl. 3 x E27, max. 10 W



602300301
602300345
602300394



01 Weiß · white
45 Pastellblau · pastel blue
94 Pastellrosa · pastel pink



EMBASSY

Stoff Grau, Acryl · fabric grey, acryl ·
tissu gris, acryl · textiel grijs, acryl · tela gris, acrílico · tessuto grigio, acrilico ·
textil gri, acrilic · tekstiili harmaa, akryyli · tkanina popielaty, akryl



↔ 30 x 30 cm, ↓ 16 cm
excl. 2 x E14, max. 40 W



603800287



↔ 50 x 50 cm, ↓ 17 cm
excl. 4 x E27, max. 60 W



603800487



CLEO

Metall, goldfarbig · metal, gold ·
metale, or · metaal, goud · metal, oro ·
metallo, oro · metal, aur ·
metalli, kultaa · metal, złota

Empfohlen:
recommended: LED GU10, 5 W
400 lm, 3.000 K



956-55



AURORA

Metall, goldfarbig · metal, gold ·
metale, or · metaal, goud · metal, oro ·
metallo, oro · metal, aur ·
metalli, kultaa · metal, złota

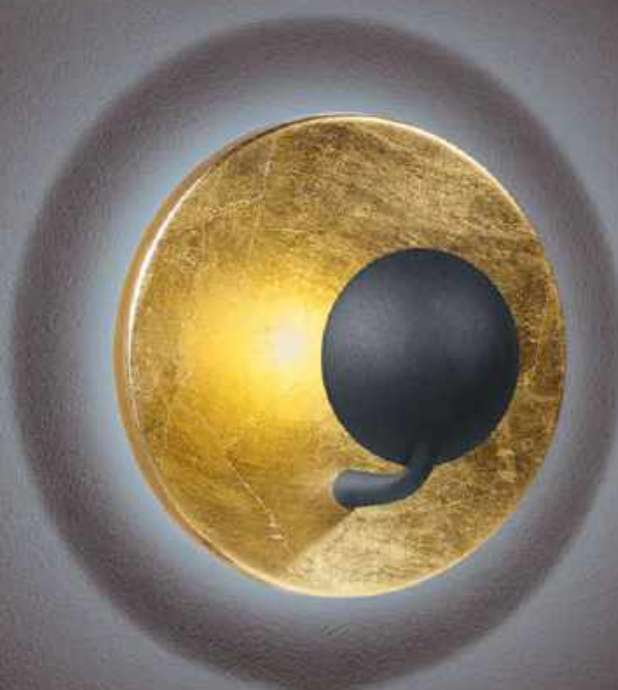

∅ 12 cm, Ø 20 cm
incl. 1 x SMD-LED, 3,1 W, 310 lm
incl. 1 x SMD-LED, 3 W, 200 lm
3.000 K



223810279



↑ 16,5 x 6 cm, ∅ 10 cm
excl. 2 x GU10, max. 35 W



206400279



↑ 15 x 8 cm, ∅ 8 cm
excl. 2 x GU10, max. 35 W



206500279



89



79

CHIROS

Metall, Glas satiniert · metal, satinated glass ·
metale, verre satiné · metaal, gesatineerd glas · metal, vidrio satinado ·
metallo, vetro satinato · metal, sticla satinata · metalli, satinoitu lasi ·
metal, szkło satynowe



79



89

429



Ø 22 cm, 7 6,5 cm
incl. 1 x SMD-LED, 8 W
700 lm, 3.000 K

224110179
224110189



Ø 32 cm, 1 6 cm
incl. 1 x SMD-LED, 12 W, 1.100 lm
incl. 1 x SMD-LED, 3,5 W, 350 lm
3.000 K

624110279
624110289



79 goldfarbig · gold
89 silberfarbig · silver



CUADRO

Altmessing oder Nickel matt · old brass or nickel mat ·
laiton fumé ou nickel mat · oud brons of nikkel mat · bronce viejo o níquel mate ·
ottone invecchiato o nichel opaco · bronz antic sau nichel mat ·
antiikkimessinki tai harjattu teräs · patyna lub nikiel mat

430



↔ 48 x 10,5 cm, ∇ 10 cm
incl. 1 x SMD-LED, 8 W
600 lm, 3.000 K



225210104
225210107

04 Altmessing · old brass
07 Nickel matt · nickel mat



CURTIS

Altmessing, Nickel matt oder Messing matt · old brass, nickel mat or brass mat ·
 laiton fumé, nickel mat ou laiton mat · oud brons, nikkel mat of messing mat ·
 bronze viejo, níquel mate o bronze mate · ottone invecchiato, nichel opaco o
 ottone satinato · bronz antic, nichel mat sau bronz mat · antiikkimessinki,
 harjattu teräs tai mattamessinki · patyna, nikiel mat lubmosiądz mat



04



07



↔ 18 cm, ↗ max. 35 cm
 incl. SMD-LED, 4 W
 380 lm, 3.000 K



279770104
 279770107
 279770108



04 Altmessing · old brass
 07 Nickel matt · nickel mat
 08 Messing matt · brass mat



07



32

ZITA

Nickel matt, Weiß matt oder Schwarz matt · nickel mat, white mat or black mat ·
 nickel mat, blanc mat ou noir mat · nikkell mat, wit mat of mat zwart ·
 níquel mate, estera blanca o estera negra · nichel opaco, bianco opaco o nero opaco ·
 nichel mat, alb mat sau negru mat · harjattu teräs, valkoinen matto tai musta matto ·
 nikiel mat, biały mat lub czarny mat



↑ 60 x 10 cm, ↗ 6,5 cm
 incl. 1 x SMD-LED, 6 W
 480 lm, 3.000 K



225870107
 225870131
 225870132



07 Nickel matt · nickel mat
31 Weiß matt · white mat
32 Schwarz matt · black mat



31



07



31

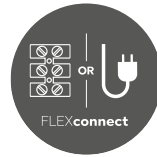

Seite/page 685



32



ALOFT

Metall · metal ·
metale · metaal · metal · metallo · metal · metalli · metal

USB Anschluss mit Ladefunktion · Recharging USB connection ·
Entrée USB de rechargement · Opladende USB aansluiting · Conexión USB de recarga ·
Connessione USB di ricarica · Conexiune USB reîncărcare · Lataaminen USB-liitäntä ·
ładowania USB połączenie



↑ 16 x 16 cm, √ 14 cm
incl. 1 x SMD-LED, 3 W
350 lm, 3.000 K

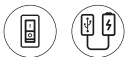

222670107
222670131
222670132

07 Nickel matt · nickel mat
31 Weiß matt · white mat
32 Schwarz matt · black mat

ELEMENT

Metall · metal ·
metale · metaal · metal · metallo ·
metal · metalli · metal · metal

USB Anschluss mit Ladefunktion · Recharging USB connection ·
Entrée USB de rechargement · Opladende USB aansluiting ·
Conexión USB de recarga · Connessione USB di ricarica ·
Conexiune USB reîncărcare · Lataaminen USB-liitäntä ·
Ładowania USB połączenie



Seite/page 685

Getrennt schaltbar · Separately switchable
Interrupteurs séparés · Gescheiden schakelbaar ·
Interruptores separados · Interruttori separati ·
Intreruptoare separate · Erikseen kytkettävissä ·
Oddzielny przełącznik

31



↑ 20 x 16 cm, ↗ 14 cm
incl. 1 x SMD-LED, 3 W
240 lm, 3.000 K
incl. 2 x SMD, 1,5 W
2 x 120 lm, 3.000 K



222570207
222570231
222570232



07 Nickel matt · nickel mat
31 Weiß matt · white mat
32 Schwarz matt · black mat



01



31



32

JORDAN

Nickel matt, Weiß matt oder Schwarz matt, Acryl · nickel mat, white mat or black mat, acryl ·
nickel mat, blanc mat ou noir mat, acryl · nikkell mat, wit mat of mat zwart, acryl ·
níquel mate, estera blanca o estera negra, acrílico · nichel opaco, bianco opaco o nero opaco, acrilico ·
nichel mat, alb mat sau negru mat, acrilic · harjattu teräs, mattavalkoinen tai mattamusta, akryyli ·
nikiel mat, biały mat lub czarny mat, akryl

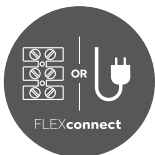

Seite/page 685



1x

2x

3x



Getrennt schaltbar · Separately switchable
Interrupteurs séparés · Gescheiden schakelbaar ·
Interruptores separados · Interruttori separati ·
Intrerupatoare separate · Erikseen kytkettävissä ·
Oddzileny przełącznik



Ø 15 cm, 12 cm
incl. 1 x SMD-LED, 5 W
550 lm, 3.000 K
incl. 1 x SMD-LED, 2 W
200 lm, 3.000 K



229210207
229210231
229210232

07 Nickel matt · nickel mat
31 Weiß matt · white mat
32 Schwarz matt · black mat



LUIGI

Metall, Weiß matt oder Schwarz matt · metal, white mat or black mat ·
 metale, blanc mat ou noir mat · metaal, wit mat of mat zwart ·
 metal, estera blanca o estera negra · metallo, bianco opaco o nero opaco ·
 metal, alb mat sau negru mat · metalli, valkoinen matto tai musta matto ·
 metal, biały mat lub czarny mat

Getrennt schaltbar · Separately switchable
 Interrupteurs séparés · Gescheiden schakelbaar · Interruptores separados ·
 Interruttori separati · Intrerupatoare separate · Erikseen kytkettävissä ·
 Oddzileny przełącznik

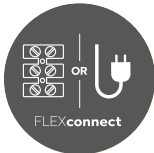

Seite/page 685



31



32

MARIO

Metall, Weiß matt oder Schwarz matt · metal, white mat or black mat ·
 metale, blanc mat ou noir mat · metaal, wit mat of mat zwart ·
 metal, estera blanca o estera negra · metallo, bianco opaco o nero opaco ·
 metal, alb mat sau negru mat · metalli, valkoinen matto tai musta matto ·
 metal, biały mat lub czarny mat

Getrennt schaltbar · Separately switchable
 Interrupteurs séparés · Gescheiden schakelbaar · Interruptores separados ·
 Interruttori separati · Intrerupatoare separate · Erikseen kytkettävissä ·
 Oddzileny przełącznik

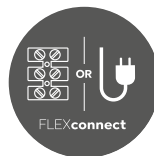

Seite/page 685



↑ 20 x 13,5 cm, ↗ 11 cm
 incl. 1 x SMD-LED, 5 W
 500 lm, 3.000 K
 incl. 1 x SMD-LED, 2,3 W
 200 lm, 3.000 K



222270231
 222270232

Ø 16 cm, ↗ 10,5 cm
 incl. 1 x SMD-LED, 6 W
 600 lm, 3.000 K
 incl. 1 x SMD-LED, 2,3 W
 200 lm, 3.000 K



222370231
 222370232



31 Weiß matt · white mat
 32 Schwarz matt · black mat

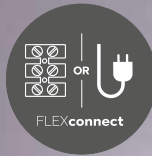

Seite/page 685



MARRIOT

Nickel matt oder goldfarbig, Stoffschirm · nickel mat or gold, fabric shade ·
 nickel mat ou or, abat-jour tissu · nikkell mat of goud, Stoffen kap · níquel mate o oro, Pantalla de tela ·
 nichel opaco o oro, paralume in tessuto · nichel mat sau aur, abajur textil ·
 harjattu teräs tai kultaa, kangas varjostin · nikiel mat lub złota, Klosz z materiału



Getrennt schaltbar · Separately switchable
 Interrupteurs séparés · Gescheiden schakelbaar ·
 Interruptores separados · Interruttori separati ·
 Intreruptoare separate · Erikseen kytkettävissä ·
 Oddzielny przełącznik



↓ 30 x 14 cm, ↗ 18 cm
 incl. 1 x SMD-LED, 3,1 W
 310 lm, 3.000 K
 excl. 1 x E14, max. 40 W



271470207
 271470279



07 Nickel matt · nickel mat
79 goldfarbig · gold



31



07



SwitchDimtoWarm

Einstellung der Helligkeit und der Lichtfarbe mit Schalter · Setting the brightness and light color with a conventional light switch · Réglage de la luminosité et de la couleur de la lumière avec un interrupteur conventionnel · Instelling van de felheid en lichtkleur met een gewone lichtschakelaar · Regulación de la claridad y del color de la luz mediante un interruptor de la luz convencional · Regolazione del colore e della luminosità della luce con un interruttore di tipo convenzionale · Reglarea luminozității și a culorii luminii prin intermediul unui întrerupător de lumină uzual · Kirkkauden ja valon värin säätäminen tavallisilla valokytkimillä · Regulacja jasności i barwy światła za pomocą konwencjonalnego włącznika światła



2.700 K



4.000 K



6.000 K

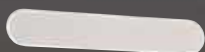

↔ 20 x 8 cm, √ 4,8 cm
incl. SMD-LED, 8,5 W
850 lm, 2.700 + 4.000 + 6.000 K



225271007
225271031

↔ 35 x 8 cm, √ 4,8 cm
incl. SMD-LED, 14 W
1.400 lm, 2.700 + 4.000 + 6.000 K



225271507
225271531

↔ 50 x 8 cm, √ 4,8 cm
incl. SMD-LED, 18 W
1.800 lm, 2.700 + 4.000 + 6.000 K



225272007
225272031



07 Nickel matt · nickel mat
31 Weiß matt · white mat





CARLO

Metall, Nickel matt oder Weiß matt · metal, nickel mat or white mat ·
metale, nickel mat ou blanc mat · metaal, nikkell mat of wit mat ·
metal, níquel mate o estera blanca · metallo, nichel opaco o bianco opaco ·
metal, nichel mat sau alb mat · metalli, harjattu teräs tai mattavalkoinen ·
metal, nikiel mat lub biały mat

LED SWITCHDIMMER





42



24

442

↔ 28 x 8 cm, ↗ 4,5 cm
incl. 2 x SMD-LED, 6 W
2 x 600 lm, 3.000 K



225172924
225172931
225172942

↔ 46,5 x 8 cm, ↗ 4,5 cm
incl. 2 x SMD-LED, 9 W
2 x 900 lm, 3.000 K



225174724
225174731
225174742



24 rostfarbig · rusty
31 Weiß matt · white mat
42 Anthrazit · anthracite

CONCHA

rostfarbig, Weiß matt oder Anthrazit · rusty, white mat or anthracite ·
 rouille, blanc mat ou anthracite · roestkleur, wit mat of antraciet · óxido, estera blanca o antracita ·
 ruggine, bianco opaco o antracite · ruginiu, alb mat sau antracit · rustiikki, mattavalkoinen tai antrasiitti ·
 miedz, biały mat lub antracyt

LED SWITCHDIMMER

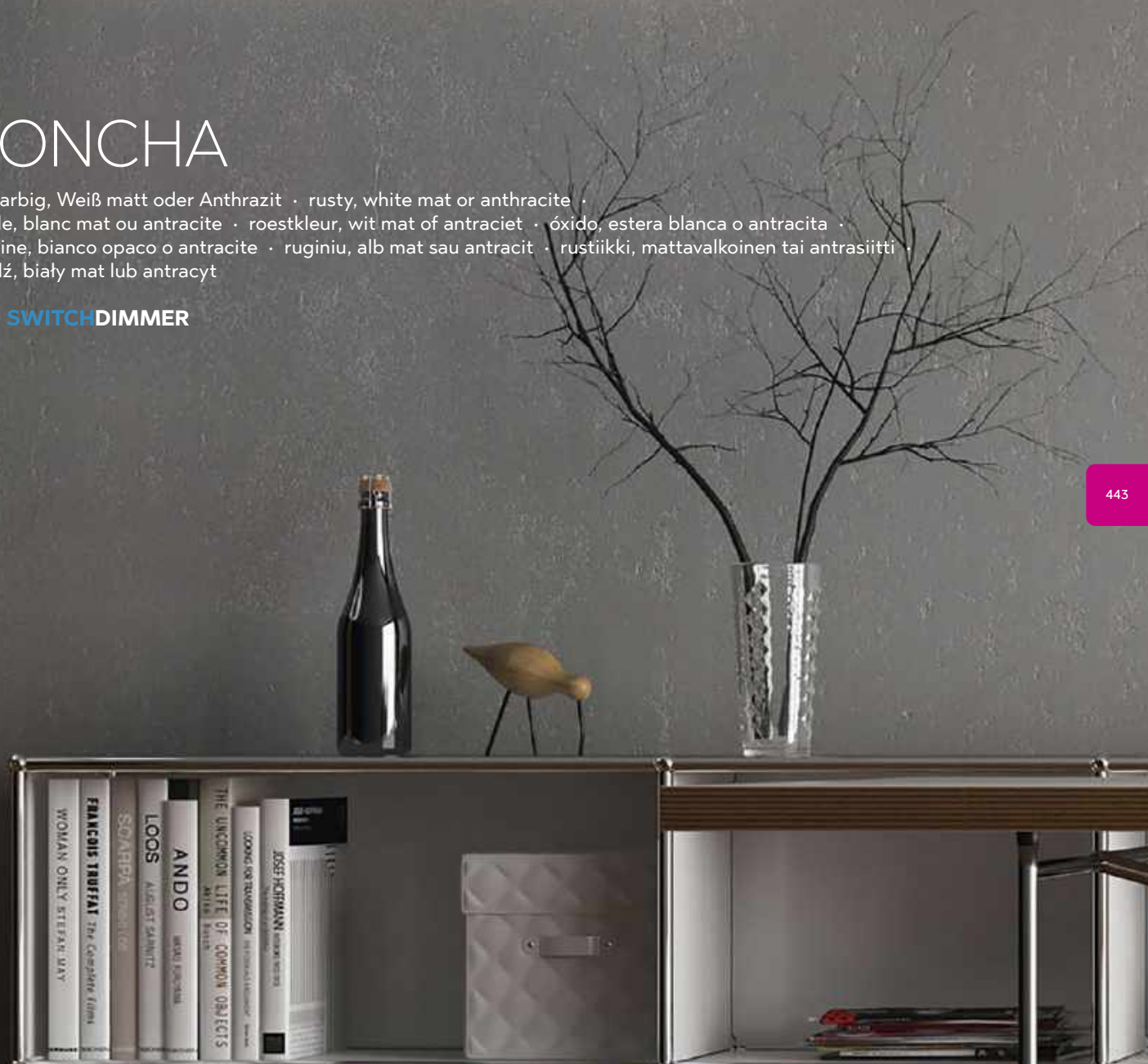



RAVEN

Schiefer, Schwarz · Shale, black ·
Ardoise, noir · Leisteen, zwart · Pizarra, negro · Ardesia, nero ·
Ardezie, negru · Savi, musta · łupek, czarny

LED SWITCHDIMMER



↔ 25 x 12 cm, ↗ 3,6 cm
incl. SMD-LED, 9 W
1.000 lm, 3.000 K



224210102

∅ 20 cm, ↗ 3,6 cm
incl. SMD-LED, 9 W
1.000 lm, 3.000 K



224290102





GASTON

Nickel matt, weiß matt oder schwarz matt · nickel mat, white mat or black mat ·
nickel mat, blanc mat ou noir mat · nikkell mat, wit mat of mat zwart ·
níquel mate, estera blanca o estera negra · nichel opaco, bianco opaco o nero opaco ·
nichel mat, alb mat sau negru mat · harjattu teräs, valkoinen matto tai musta matto ·
nikiel mat, biały mat lub czarny mat

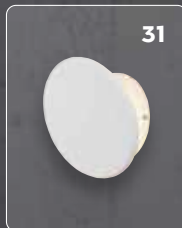

Ø 21,5 cm, 7,5 cm
incl. 1 x SMD-LED, 8 W
700 lm, 3.000 K



222710107
222710131
222710132



01 Nickel matt · nickel mat
31 Weiß matt · white mat
32 Schwarz matt · black mat

07



31



LACAPO

Metall · metal ·
metale · metaal · metallo ·
metal · metalli · metal



↔ 10,5 cm, ↑ 6 cm, ↗ 15 cm
incl. SMD-LED, 4,3 W
430 lm, 3.000 K



223410107
223410131
223410132

07 Nickel matt · nickel mat
31 Weiß matt · white mat
32 Schwarz matt · black mat



32



28



07

BOLERO

Metall · metal ·
metale · metaal · metal · metallo ·
metal · metalli · metal



↑ 38 x 6 cm, √ 8 cm
incl. 2 x SMD-LED, 3,1 W
2 x 310 lm, 3.000 K



221570207
221570228



07 Nickel matt · nickel mat
28 rostfarbig antik · antique rusty

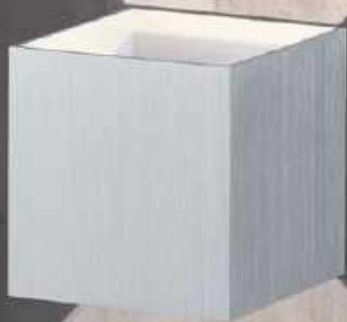

05



32

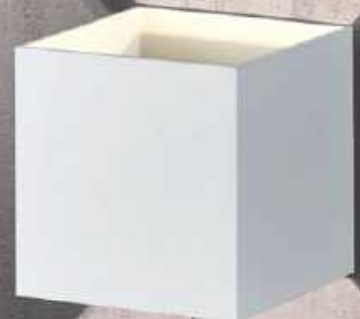

31

LOUIS

Metall · metal ·
metale · metaal · metallo ·
metal · metalli · metal · metal



↑ 10 x 10 cm, ↗ 10 cm
incl. 1 x OSRAM-LED, 4,3 W
430 lm, 3.000 K



223310105
223310131
223310132



05 Aluminium gebürstet · brushed aluminium
31 Weiß matt · white mat
32 Schwarz matt · black mat

MELVIN

Metall, Schwarz matt oder Nickel antik · metal, black mat or nickel antique ·
metale, noir mat ou nickel antique · metaal, mat zwart of antiek nikkel ·
metal, estera negra o níquel antiguo · metallo, nero opaco o nickel anticato ·
metal, negru mat sau nichel antic · metalli, mattamusta tai antiikkiteräs ·
metal, czarny mat lub aikiel antyczny

LED SWITCHDIMMER



↑ 8,5 x 11 cm, ↗ 10 cm
incl. OSRAM-LED, 4,3 W
430 lm, 3.000 K



223910132
223910167



32 Schwarz matt · black mat
67 Nickel antik · nickel antique





MIGUEL

Metall, Weiß matt oder Schwarz matt · metal, white mat or black mat ·
metale, blanc mat ou noir mat · metaal, wit mat of mat zwart · metal, estera blanca o estera negra ·
metallo, bianco opaco o nero opaco · metal, alb mat sau negru mat · metalli, valkoinen matto tai musta matto ·
metal, biały mat lub czarny mat

LED SWITCHDIMMER



↔ 20,5 x 16,5 cm, ↗ 8,3 cm
incl. SMD-LED, 2 x 6 W
2 x 500 lm, 3.000 K



224910231
224910232



31 Weiß matt · white mat
32 Schwarz matt · black mat

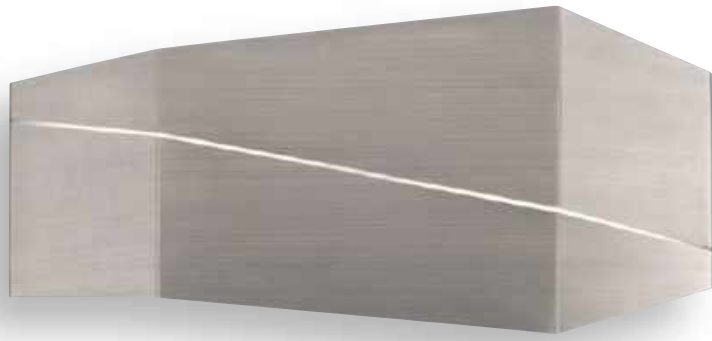

07

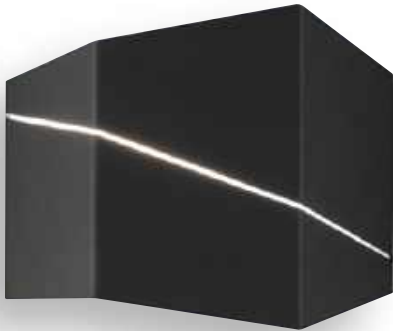

32

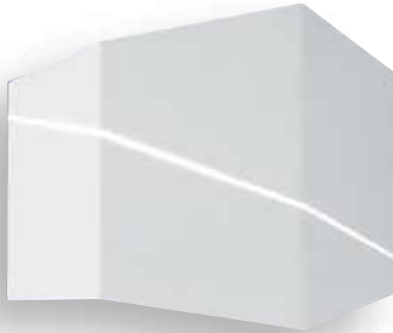

31



ZORRO

Nickel matt, Weiß matt oder Schwarz matt · nickel mat, white mat or black mat ·
 nickel mat, blanc mat ou noir mat · nikkell mat, wit mat of mat zwart ·
 níquel mate, estera blanca o estera negra · nichel opaco, bianco opaco o nero opaco ·
 nichel mat, alb mat sau negru mat · harjattu teräs, valkoinen matto tai musta matto ·
 nikiel mat, biały mat lub czarny mat

452



↔ 18 x 14,5 cm, √ 6,5 cm
 incl. 1 x SMD-LED, 6,5 W
 500 lm, 3.000 K



↔ 40 x 18 cm, √ 6,5 cm
 incl. 1 x SMD-LED, 13 W
 1.000 lm, 3.000 K



223210107
 223210131
 223210132

223210207
 223210231
 223210232

07 Nickel matt · nickel mat
31 Weiß matt · white mat
32 Schwarz matt · black mat

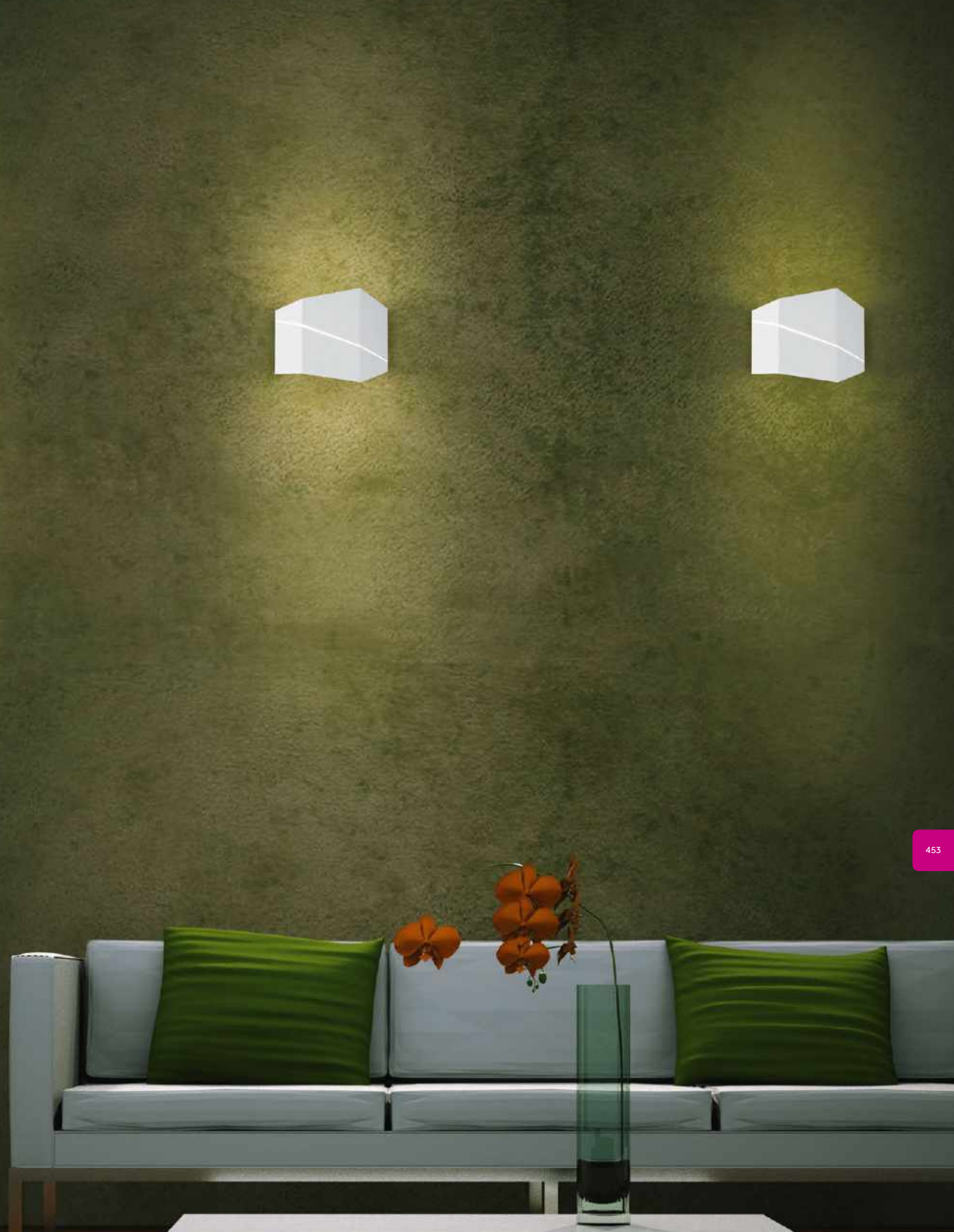

ESCALATE

Aluminium gebürstet · brushed aluminium ·
aluminium balayé · geborsteld aluminium · aluminio pulido ·
alluminio spazzolato · aluminiu lucios · harjattu alumiini · aluminium szczotkowane

454



↔ 33,7 x 6,7 cm, ↗ 5,3 cm
incl. 2 x SMD-LED, 3,8 W
2 x 380 lm, 3.000 K



222410205

LENTIL

Chrom · chrome ·
chrome · chrom ·
cromo · cromo · crom ·
kromi · chrom



Farblinsen separat erhältlich ·
Color lenses separately available ·
Lentilles de couleur disponibles séparément ·
Verschillende kleurlenze speeraat leverbaar ·
Lentes de colores disponibles por separado ·
Filtri colorati venduti separatamente ·
Lentile colorate disponibile ·
Väri­linssit saatavilla erikseen ·
Soczewki kolorowe dostępne osobno

Product No. **92805**



↑ 12,5 x 7,5 cm, ↗ 13,5 cm
incl. 2 x SMD-LED, 2,3 W
2 x 240 lm, 3.000 K



272570206



PLATON

Aluminium gebürstet, Acryl · brushed aluminium, acryl ·
aluminium balayé, acryl · geborsteld aluminium, acryl ·
aluminio pulido, acrílico · alluminio spazzolato, acrilico ·
aluminium lucios, acrilic · harjattu alumiini, akryyli ·
aluminium szczotkowane, akryl

456



↔ 13 x 18 cm, √ 9 cm
incl. 1 x SMD-LED, 4,5 W
430 lm, 3.000 K



274670105



↔ 30 x 18 cm, √ 11 cm
incl. 2 x SMD-LED, 4,5 W
2 x 430 lm, 3.000 K



274670205



WALES

Nickel matt · nickel mat ·
nickel mat · nikkell mat ·
níquel mate · nichel opaco ·
nichel mat · harjattu teräs ·
nikiel mat



ABERDEEN

Nickel matt · nickel mat ·
nickel mat · nikkell mat · níquel mate · nichel opaco ·
nichel mat · harjattu teräs · nikiel mat



↔ 9 cm, ↑ 9 cm, ↗ 6 cm
incl. 2 x SMD-LED, 3,2 W
2 x 300 lm, 3.000 K



225510207



↔ 20 cm, ↑ 8 cm, ↗ 7 cm
incl. 6 x SMD-LED, 1 W
6 x 100 lm, 3.000 K



225610607

ADRIANO

Aluminium gebürstet oder Weiß · brushed aluminium or white · aluminium balayé ou blanc · geborsteld aluminium of wit · aluminio pulido o blanco · alluminio spazzolato o bianco · aluminiu lucios sau alb · harjattu alumiini tai valkoinen · aluminium szczotkowane lub biały

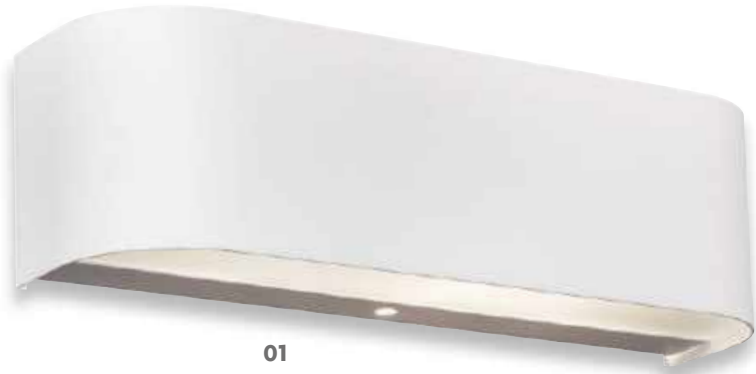

01



05



ENRICO

Nickel matt · nickel mat · nickel mat · nikkellat · níquel mate · nichel opaco · nichel mat · harjattu teräs · nikiel mat

Empfohlen:
recommended: LED GU10, 5 W
400 lm, 3.000 K



956-55

458



↔ 30 x 6 cm, ↗ 8 cm
incl. 2 x SMD-LED, 3,1 W
2 x 310 lm, 3.000 K



220810201
220810205



↑ 15 x 8 cm, ↗ 8 cm
excl. 2 x GU10, max. 35 W



261100207



01 Weiß · white
05 Aluminium gebürstet · brushed aluminium
07 Nickel matt · nickel mat



CUBE

Beton · concrete ·
béton · beton · hormigón ·
cemento · beton · betoni · beton

Empfohlen:
recommended: LED GU10, 5 W
400 lm, 3.000 K



956-55



↑ 15 cm, ↔ 10 x 10 cm
excl. 1 x GU10, max. 35 W



606600178



↑ 15 x 10 cm, ↗ 9 cm
excl. 2 x GU10, max. 35 W



206600278



ROMA

Gips · Gypsum ·
Plâtre · Gips · Yeso ·
Gesso · Gips · Kipsi · Gips



ZAZOU

Gips · Gypsum ·
Plâtre · Gips · Yeso ·
Gesso · Gips · Kipsi · Gips



OVIEDO

Gips · Gypsum ·
Plâtre · Gips · Yeso ·
Gesso · Gips · Kipsi · Gips



460



↔ 24,5 x 9,5 cm, ↗ 12 cm
excl. 1 x E14, max. 28 W

↓ 16,5 cm, ↔ 7,5 cm, ↗ 7 cm
excl. 2 x GU10, max. 35 W

↔ 15 x 12,5 cm, ↗ 13 cm
excl. 1 x G9, max. 28 W



201000101

201100201

201400101

Freiräume für eigene Ideen

Open spaces for your own ideas · Espace libre pour vos propres idées ·
Vrijheid voor uw eigen ideeën · Espacios abiertos para sus propias ideas ·
Spazi aperti alle vostre idee · Spații libere pentru propriile idei ·
Vapaata tilaa omille ideoillesi · Otwarta przestrzeń do realizacji własnych
pomysłów



Überstreichbare Gipsleuchten ·

Gypsum lights that can be painted · Lampes en gypse à peindre ·
overschilderbare gipslampen · Lámparas de yeso que pueden pintarse ·
Le lampade in gesso possono essere verniciate · Lămpi de ipsos, ce pot
fi vopsite · Maalattava kipsivalaisin · Oświetlenie gipsowe, które można pomalować



IRIS

Gips · Gypsum ·
Plâtre · Gips · Yeso ·
Gesso · Gips · Kipsi · Gips

Empfohlen:
recommended: Filament LED E27, 7 W
680 lm, 2.700 K



988-710

Empfohlen:
recommended: Filament LED E27, 7 W
680 lm, 2.700 K



986-710

55 cm

LILLY

Gips · Gypsum ·
Plâtre · Gips · Yeso · Gesso ·
Gips · Kipsi · Gips



462



Ø 30 cm, ↑ 5 cm
excl. 1 x E27, max. 40 W



603400101



Ø 55 cm, ↑ 8 cm
excl. 1 x E27, max. 40 W



603490101



Ø 30 cm, ↑ 6 cm
excl. 1 x E27, max. 40 W



603300101



Ø 55 cm, ↑ 8 cm
excl. 1 x E27, max. 40 W



603390101

TATRA

Gips · Gypsum ·
Plâtre · Gips · Yeso ·
Gesso · Gips · Kipsi · Gips

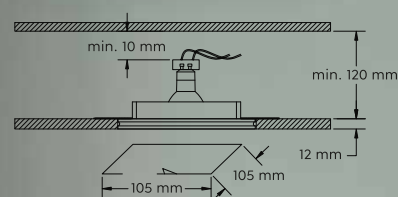
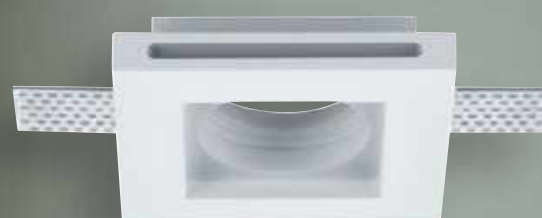
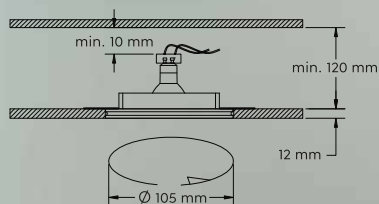

Überstreichbare Gipsleuchten ·

Gypsum lights that can be painted ·
Lampes en gypse à peindre ·
overschilderbare gipslampen ·
Lámparas de yeso que pueden pintarse ·
Le lampade in gesso possono essere verniciate ·
Lāmpi de ipsos, ce pot fi vopsite ·
Maalattava kipsivalaisin ·
Oświetlenie gipsowe, które można pomalować



Ø 10 cm, ↑ 2,7 cm
excl. 1 x GU10, max. 28 W

↔ 10 x 10 cm, ↑ 2,7 cm
excl. 1 x GU10, max. 28 W



651300101

651400101

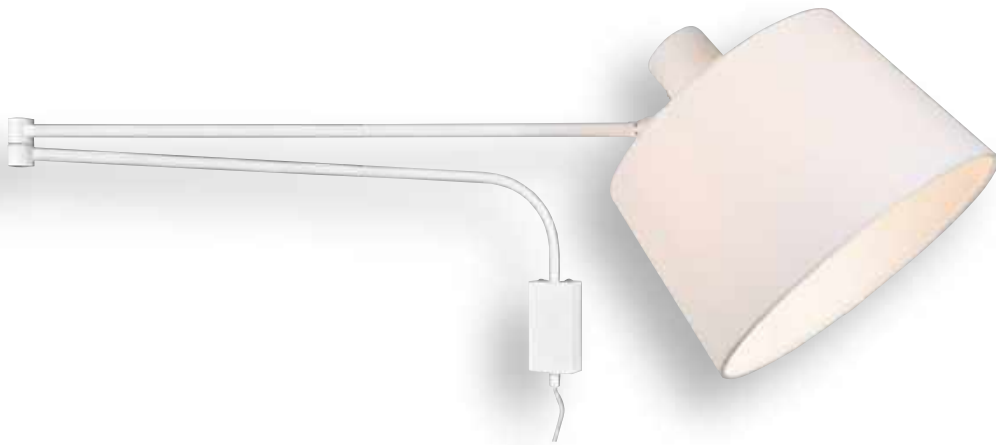

BALDO

Metall, Weiß matt oder Schwarz matt, Stoffschirm ·
 metal, white mat or black mat, fabric shade ·
 metale, blanc mat ou noir mat, abat-jour tissu ·
 metaal, wit mat of mat zwart, Stoffen kap ·
 metal, estera blanca o estera negra, Pantalla de tela ·
 metallo, bianco opaco o nero opaco, paralume in tessuto ·
 metal, alb mat sau negru mat, abajur textil ·
 metalli, valkoinen matto tai musta matto, kangas varjostin ·
 metal, biały mat lub czarny mat, Klosz z materiału

464



Ø 28 cm, ↗ max. 150 cm,
 excl. 1 x E27, max. 40 W



200600131
 200600132



31 Weiß matt · white mat
 32 Schwarz matt · black mat







LINE

Metall, Weiß matt oder Schwarz matt · metal, white mat or black mat ·
 metale, blanc mat ou noir mat · metaal, wit mat of mat zwart ·
 metal, estera blanca o estera negra · metallo, bianco opaco o nero opaco ·
 metal, alb mat sau negru mat · metalli, valkoinen matto tai musta matto ·
 metal, biały mat lub czarny mat

Empfohlen:

recommended: Filament LED E27, 6 W
 190 lm, 3.000 K



988-654

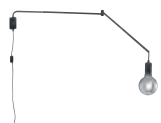

∅ max. 150 cm
 excl. 1 x E27, max. 40 W



200200131
200200132



∅ 35,5 cm, ∅ max. 150 cm
 excl. 1 x E27, max. 40 W



200300131
200300132



31 Weiß matt · white mat
32 Schwarz matt · black mat



BOLDER

Metall, Weiß matt oder Schwarz matt · metal, white mat or black mat ·
metale, blanc mat ou noir mat · metaal, wit mat of mat zwart ·
metal, estera blanca o estera negra · metallo, bianco opaco o nero opaco ·
metal, alb mat sau negru mat · metalli, valkoinen matto tai musta matto ·
metal, biały mat lub czarny mat

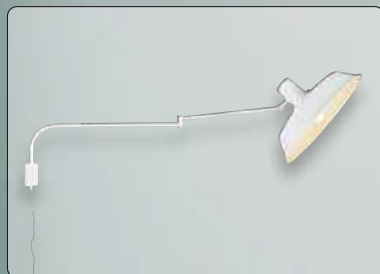



VITA

Glas alabasterfarbig · alabaster-coloured glass ·
verre couleur albâtre · albastkleurig glas · vidrio de color alabastro ·
vetro colore alabastro · sticla culoare alabastru · lasi alabasteri väri ·
szkło alabaster kolor



MIRO

Glas matt · mat glass ·
verre mat · mat glas · vidrio mate · vetro sabbato ·
sticla mata · mattalasi · szkło matowane



DIVO

Chrom, Glas · chrome, glass ·
chrome, verre · chroom, glas · cromo, vidrio ·
cromo, vetro · crom, sticla · kromi, lasi · chrom, szkło



MARTA

Chrom, Glas · chrome, glass ·
chrome, verre · chroom, glas · cromo, vidrio ·
cromo, vetro · crom, sticla · kromi, lasi · chrom, szkło



↓ 40 cm, ↔ 18,5 cm, ↗ 9,5 cm
excl. 2 x E14, max. 40 W



2501021-01



↓ 29 cm, ↔ 20 cm, ↗ 11 cm
excl. 1 x E27, max. 60 W



2524011-07



↔ 20 x 20 cm, ↗ 8 cm
excl. 1 x E14, max. 40 W



2522011-06



↔ 20 x 20 cm, ↗ 8 cm
excl. 1 x E14, max. 40 W



2523011-01



FACELLA

rostfarbig, Glas alabasterfarbig · rusty, alabaster-coloured glass ·
rouille, verre couleur albâtre · roestkleur, albastkleurig glas ·
óxido, vidrio de color alabastro · ruggine, vetro colore alabastro ·
ruginiu, sticla culoare alabastru · rustiikki, lasi alabasteri väri ·
miedź, szkło alabaster kolor



CAMPO

rostfarbig, Scavo glas · rusty, scavo glass ·
rouille, verre scavo · roestkleur, scavo glas ·
óxido, vidrio scavo · ruggine, vetro scavo ·
ruginiu, sticla scavo · rustiikki, scavo-lasi ·
miedź, szkło scavo



CONO

Nickel matt oder rostfarbig, Glas · nickel mat or rusty, glass ·
nickel mat ou rouille, verre · nikkell mat of roestkleur, glas ·
níquel mate o óxido, vidrio · nichel opaco o ruggine, vetro ·
nichel mat sau ruginiu, sticla · harjattu teräs tai rustiikki, lasi ·
nikiel mat lub miedź, szkło



↓ 44 cm, ↔ 12 cm, ↗ 16 cm
excl. 1 x E14, max. 40 W



200970124

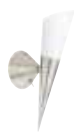

↓ 35 cm, ↔ 10 cm, ↗ 15 cm
excl. 1 x E14, max. 60 W



2502211-07



↓ 27 cm, ↔ 5,5 cm, ↗ 10 cm
excl. 1 x G9, max. 28 W



216070124



07 Nickel matt · nickel mat
24 rostfarbig · rusty



LAON

Nickel matt · nickel mat ·
nickel mat · nikkel mat ·
níquel mate · nichel opaco ·
nichel mat · harjattu teräs ·
nikiel mat

LED SWITCHDIMMER



FRED

Glas matt · mat glass ·
verre mat · mat glas ·
vidrio mate · vetro sabbiato ·
sticla mata · mattalasi ·
szkło matowane

LED SWITCHDIMMER



LIGARA

Kunststoff · plastic ·
plastique · kunststof ·
plástico · plastica · plastic ·
muovi · plastik



↓ 40 cm, ↗ max. 20 cm
incl. 1 x LED G9, 3,5 W
320 lm, 3.000 K



891770107



↓ 40 cm, ↗ max. 16 cm
incl. 1 x LED GU10, 5 W
400 lm, 3.000 K



899670107



↓ 28 cm, ↗ max. 20 cm
excl. 1 x E14, max. 40 W



8911211-07

LEVISTO

Glas alabasterfarbig · alabaster-coloured glass ·
verre couleur albâtre · albastkleurig glas · vidrio de color alabastro ·
vetro colore alabastro · sticla culoare alabastru · lasi alabasteri väri ·
szkło alabaster kolor

LED SWITCHDIMMER



471



↑ 40 cm, √ max. 22 cm
incl. 1 x LED E14, 6 W
470 lm, 3.000 K



891010107

SIMEO

Kunststoff, Weiß · plastic, white ·
plastique, blanc · kunststof, wit · plástico, blanco ·
plastica, bianco · plastic, alb · muovi, valkoinen ·
plastik, biały





Gestensteuerung · Gesture control ·
Contrôle gestuel · Gebaarbediening ·
Control gestual · Controllo gestuale ·
Control prin gesturi/miscarea mainii ·
Kädellä ohjattava liiketunnistin ·
Sterowana gestami

473



↔ 52,8 x 6,8 cm, ↑ 1,8 cm
incl. SMD-LED, 10 W
850 lm, 3.000 K



273271201



↔ 77 x 6,8 cm, ↑ 1,8 cm
incl. SMD-LED, 15,5 W
1.300 lm, 3.000 K



273271801





ARAGON

Kunststoff, Weiß oder titanfarbig · plastic, white or titan ·
 plastique, blanc ou titane · kunststof, wit of titaan · plástico, blanco o titán ·
 plastica, bianco o titano · plastic, alb sau titaniu · muovi, valkoinen tai titaani ·
 plastik, biały lub tytanowy



ALINO

Kunststoff, Weiß oder titanfarbig · plastic, white or titan ·
 plastique, blanc ou titane · kunststof, wit of titaan · plástico, blanco o titán ·
 plastica, bianco o titano · plastic, alb sau titaniu · muovi, valkoinen tai titaani ·
 plastik, biały lub tytanowy



↔ 40 x 4 cm, ↓ 2 cm
 incl. 3 x SMD-LED, 1 W
 3 x 80 lm, 3.000 K



273170301
273170387

↔ 55 x 4 cm, ↓ 2 cm
 incl. 4 x SMD-LED, 1 W
 4 x 80 lm, 3.000 K



273170401
273170487

↔ 34 x 7 cm, ↓ 2 cm
 incl. SMD-LED, 4 W
 350 lm, 3.000 K



272970401
272970487

↔ 55 x 7 cm, ↓ 2 cm
 incl. SMD-LED, 7 W
 600 lm, 3.000 K



272970701
272970787



01 Weiß · white
87 titanfarbig · titanium-coloured



RAMON

Kunststoff · plastic ·
 plastique · kunststof · plástico · plastica ·
 plastic · muovi · plastik

476

↔ 28 x 2,5 cm, ↑ 4 cm
 incl. 1 x SMD-LED, 4 W
 350 lm, 3.000 K



273070401

↔ 51 x 2,5 cm, ↑ 4 cm
 incl. 1 x SMD-LED, 7 W
 600 lm, 3.000 K



273070701

↔ 84 x 2,5 cm, ↑ 4 cm
 incl. 1 x SMD-LED, 13 W
 1.100 lm, 3.000 K



273071301

↔ 114 x 2,5 cm, ↑ 4 cm
 incl. 1 x SMD-LED, 18 W
 1.500 lm, 3.000 K



273071801



ECCO

Nickel matt · nickel mat ·
nickel mat · nikkell mat · níquel mate · nichel opaco ·
nichel mat · harjattu teräs · nikiel mat

477



↔ 13 x 13 cm, ↓ 4 cm
incl. 3 x SMD-LED, 3 W
3 x 200 lm, 3.000 K



273370307 Set: 3 St./3 pc.



Tisch- & Stehleuchten

Table- & floor lamps

Lampes de table & lampadaires

Tafel- & vloerlampen

Sobremesas y lámparas de pie

Lampade da tavolo e piantane

Veioze si lampadare

Pöytä- & lattia

Stołowe i podłogowe





4.000 Kelvin

BANGKOK

Metall, Marmor · metal, marble ·
metale, marbre · metaal, marmer · metal, mármol ·
metallo, marmo · metal, marmura · metalli, marmori ·
metal, marmur



31



07



↔ 32 x 22 cm, ↑ 180 cm, ↗ 128 cm
incl. SMD-LED, 18 W
1.400 lm, 3.000 K



426511807
426511832



↔ 32 x 22 cm, ↑ 180 cm, ↗ 128 cm
incl. SMD-LED, 18 W
1.800 lm, 4.000 K



426511831



07 Nickel matt · nickel mat
31 Weiß matt · white mat
32 Schwarz matt · black mat



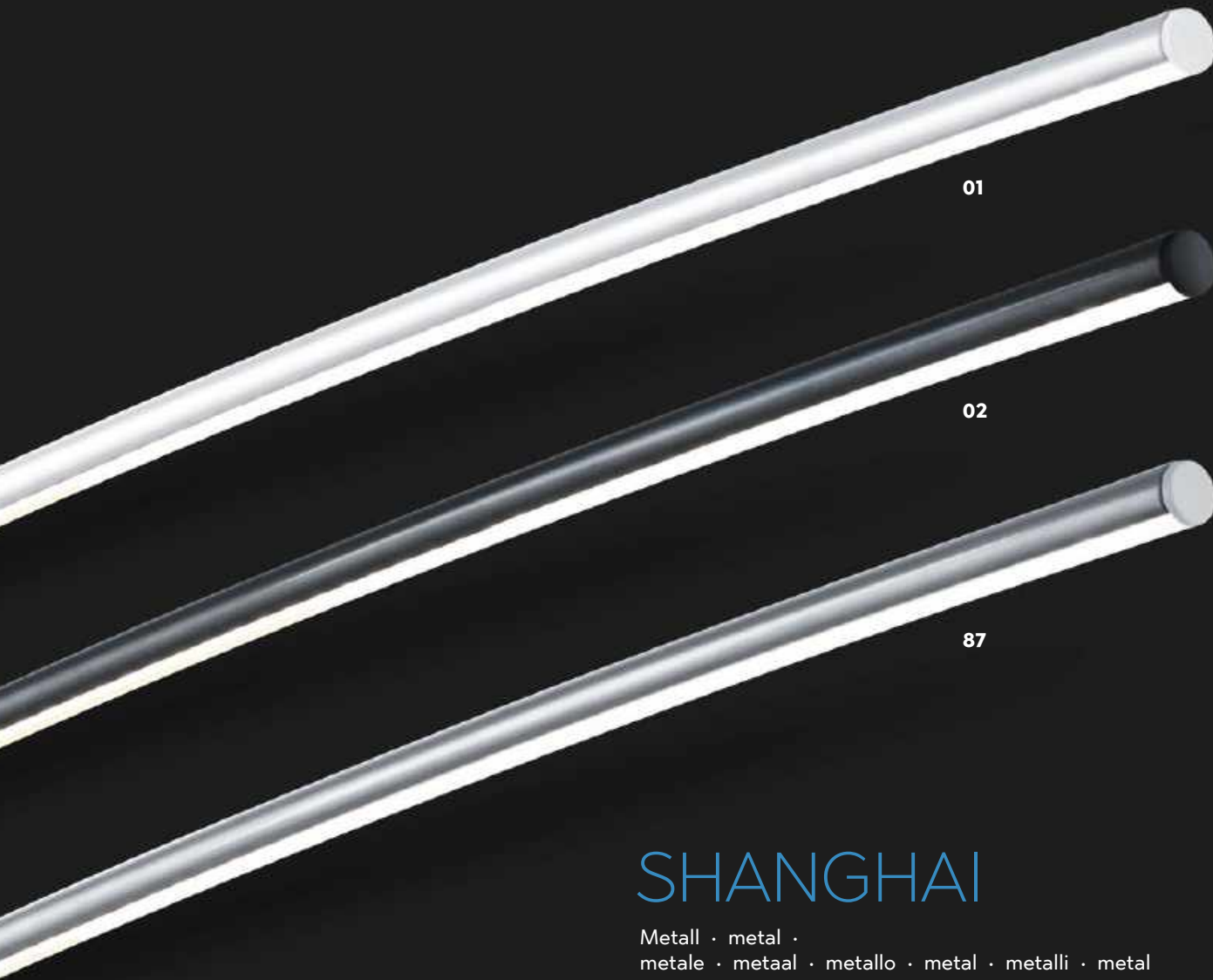

01

02

87

SHANGHAI

Metall · metal ·
metale · metaal · metallo · metal · metalli · metal

482

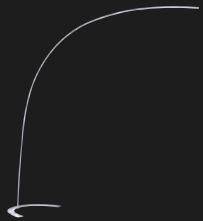

↑ 210 cm, ↔ 65 cm, ↗ 200 cm
incl. SMD-LED, 18 W
1.800 lm, 3.000 K



427511801
427511802
427511887



01 Weiß · white
02 Schwarz · black
87 titanfarbig · titanium-coloured





FLORESTAN

Nickel matt · nickel mat ·
nickel mat · nikkell mat · níquel mate ·
nichel opaco · nichel mat · harjattu teräs · nikiel mat



484



↑ 180 cm, Ø 32,5 cm, √ 100 cm
incl. 4 x SMD-LED, 4,3 W
4 x 430 lm, 3.000 K



429910107

SOLA

Chrom, Marmor, Acryl · chrome, marble, acryl ·
chrome, marbre, acryl · chroom, marmer, acryl ·
cromo, mármol, acrílico · cromo, marmo, acrílico ·
crom, marmura, acrilic · kromi, marmori, akryyli ·
chrom, marmur, akryl

485

↑ 176 - 200 cm, ↗ 180 cm, Ø 40 cm
excl. 1 x E27, max. 75 W



4200011-06



32



08

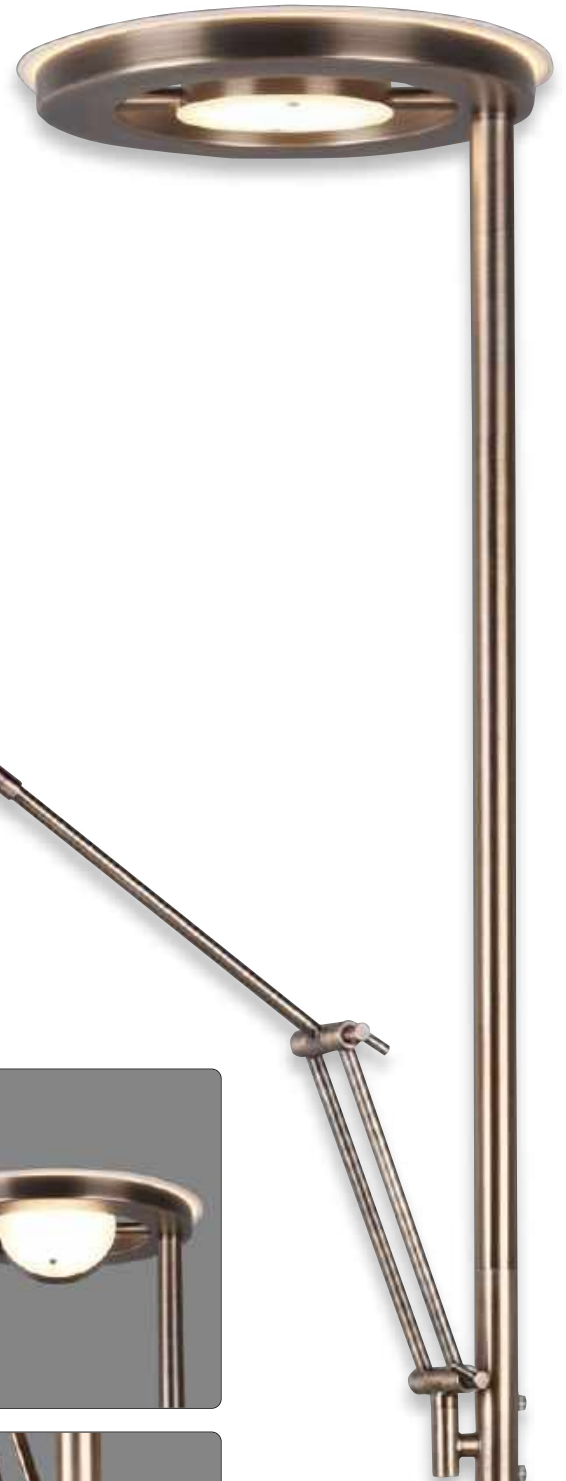

04

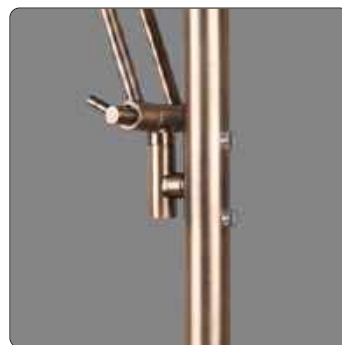

↑ 181 cm, Ø 30 cm, √ 70 cm
incl. SMD-LED, 32 W, 4.000 lm
incl. SMD-LED, 6 W, 600 lm
2.700 + 4.000 K



- 424210304
- 424210307
- 424210308
- 424210332

- 04 Altmessing · old brass
- 07 Nickel matt · nickel mat
- 08 Messing matt · brass mat
- 32 Schwarz matt · black mat

BARRIE

Metall · metal ·
metale · metaal · metal · metallo ·
metal · metalli · metal





07



04



08



↑ 180 cm, Ø 30 cm, ∠ 50 cm
incl. SMD-LED, 33 W, 2.950 lm
incl. SMD-LED, 7,5 W, 650 lm
2.700 + 3.350 + 4.000 K



- 423010204
- 423010207
- 423010208
- 423010232

- 04 Altmessing · old brass
- 07 Nickel matt · nickel mat
- 08 Messing matt · brass mat
- 32 Schwarz matt · black mat



EDMONTON

Metall · metal ·
metale · metaal · metal · metallo ·
metal · metalli · metal



32



07



schwenkbar · tiltable ·
pivotant · draaibaar ·
pivotante · girevole ·
pivotant · suunnattava ·
skrętny



490

Dimmen und Lichtfarbe einstellen ·
Dimming and adjusting light color ·
Varier et choisir la couleur de la lumière ·
Dimmen en lichtkleur instellen ·
Atenuación y ajuste del color de la luz ·
Variare e scegliere il colore della luce ·
Variati lumina si ajustati culoarea luminii ·
Himmennys ja värilämpötilan säätö vakiokytkimellä ·
ściemniać i jasność ustawiać





08

QUEBEC

Nickel matt oder Messing matt · nickel mat or brass mat ·
nickel mat ou laiton mat · nikkil mat of messing mat ·
níquel mate o bronce mate · nichel opaco o ottone satinato ·
nichel mat sau bronz mat · harjattu teräs tai mattamessinki ·
nikiel mat lub mosiądz mat



491



↑ 180 cm, ↗ 50 cm
incl. SMD-LED, 34 W
3.000 lm, 3.000 - 6.000 K
incl. SMD-LED, 5,5 W
400 lm, 3.000 - 6.000 K



422710307
422710308



07 Nickel matt · nickel mat
08 Messing matt · brass mat

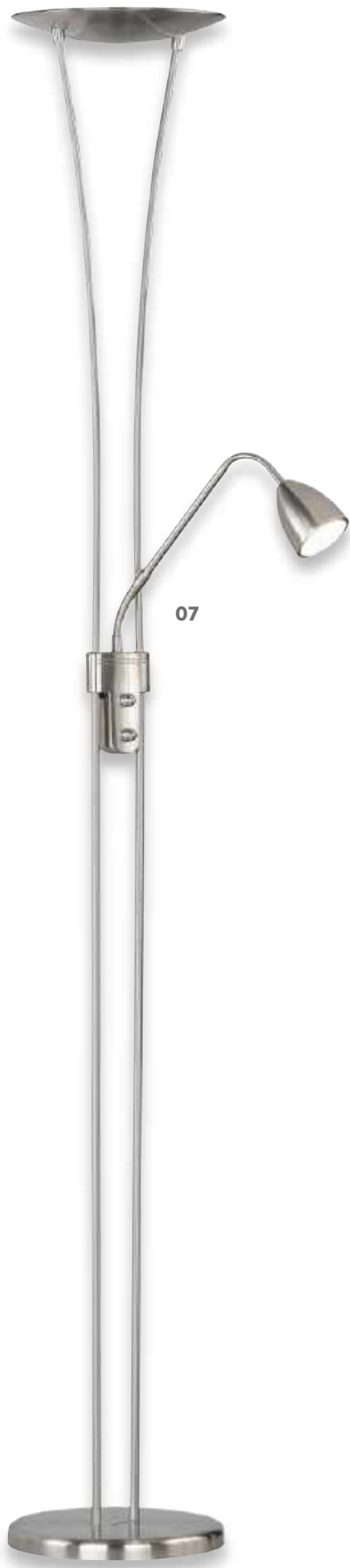

ARIZONA

Nickel matt oder Messing matt ·
 nickel mat or brass mat ·
 nickel mat ou laiton mat ·
 nikkell mat of messing mat ·
 níquel mate o ottone satinato ·
 nichel opaco o ottone satinato ·
 nichel mat sau bronz mat ·
 harjattu teräs tai mattamessinki ·
 nikiel mat lub mosiądz mat



↑ 180 cm, Ø 25,5 cm, √ 40 cm
 incl. SMD-LED, 20 W, 2.000 lm, 3.000 K
 incl. 1 x SMD-LED, 5 W, 500 lm, 3.000 K



426410207
 426410208

07 Nickel matt · nickel mat
 08 Messing matt · brass mat



ARANGO

Nickel matt oder Altmessing · nickel mat or old brass ·
nickel mat ou laiton fumé · nikkell mat of oud brons ·
níquel mate o bronce viejo · nichel opaco o ottone invecchiato ·
nichel mat sau bronz antic · harjattu teräs tai antiikkimessinki ·
nikiel mat lub patyna



↑ 180 cm, Ø 31 cm
incl. 1 x SMD-LED, 20 W
1.750 lm, 3.000 K



429110104
429110107



04 Altmessing · old brass
07 Nickel matt · nickel mat



28

SANTO II

Metall, Glas alabasterfarbig ·
metal, alabaster-coloured glass ·
metale, verre couleur albâtre ·
metaal, albastkleurig glas ·
metal, vidrio de color alabastro ·
metallo, vetro colore alabastro ·
metal, sticla culoare alabastru ·
metalli, lasi alabasteri väri ·
metal, szkło alabaster kolor



07

494



↑ 180 cm, Ø 25,5 cm, √ 40 cm
incl. 4 x SMD-LED, 4,5 W, 4 x 440 lm, 3.000 K
incl. 1 x SMD-LED, 4,5 W, 440 lm, 3.000 K



421910207
421910228



07 Nickel matt · nickel mat
28 rostfarbig antik · antique rust

RUSTICA

rostfarbig, Glas matt · rusty, mat glass ·
rouille, verre mat · roestkleur, mat glas ·
óxido, vidrio mate · ruggine, vetro sabbato ·
ruginiu, sticla mata · rustiikki, mattalasi ·
miedz, szklo matowane



495



↑ 180 cm, Ø 32,5 cm
excl. 1 x E27, max. 100 W
excl. 1 x E14, max. 40 W



4602021-24

SPLIT

Nickel matt · nickel mat ·
nickel mat · nikkell mat · níquel mate ·
nichel opaco · nichel mat · harjattu teräs ·
nikiel mat



496



↑ 180 cm, √ 43 cm
incl. SMD-LED, 20 W
2.000 lm, 3.000 - 6.500 K
incl. 1 x SMD-LED, 3,5 W
340 lm, 3.000 - 6.500 K



424910207

Stufenlos dimmbar, Lichtfarbe stufenlos einstellbar ·
infinitely dimmable, light color infinitely variable ·
infiniment dimmable, couleur de lumière infiniment
variable · traploos dimbaar, lichtkleur traploos
instelbaar · sin etapas regulable, color de luz
infinitamente variable · infinitamente dimmerabile,
colore della luce infinitamente variabile ·
variator de lumina fara trepte, cu intrerupator
standard de lumina · portaaton himmennys,
valon väri portaattomasti · bezstopniowe
ściemnianie, jasny kolor bezstopniowo





PILLAR

Chrom, Acryl · chrome, acryl ·
chrome, acryl · chroom, acryl · cromo, acrílico ·
cromo, acrílico · crom, acrílic · kromi, akryyli ·
chrom, akryl



↑ 150 cm, Ø 24 cm
incl. 1 x SMD-LED, 24 W
max. 2.000 lm, 3.000 K



423510101



07

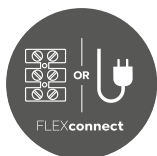

Seite/page 685



KAZAN

Nickel matt oder Schwarz matt · nickel mat or black mat ·
 nickel mat ou noir mat · nikkell mat of mat zwart ·
 níquel mate o estera negra · nichel opaco o nero opaco ·
 nichel mat sau negru mat · harjattu teräs tai musta matto ·
 nikiel mat lub czarny mat



Ø 14 cm, √ max. 55 cm
 incl. 1 x SMD, 8 W
 750 lm, 3.000 K



274770107
 274770132



↑ 46 cm, Ø 17 cm, √ max. 53 cm
 incl. 1 x SMD, 8 W
 750 lm, 3.000 K



574790107
 574790132



↑ 120 cm, Ø 24 cm, √ max. 61 cm
 incl. 1 x SMD, 8 W
 750 lm, 3.000 K



474790107
 474790132



07 Nickel matt · nickel mat
 32 Schwarz matt · black mat



32



CALCIO

Nickel matt oder Messing matt · nickel mat or brass mat ·
nickel mat ou laiton mat · nikkel mat of messing mat ·
níquel mate o bronze mate · nichel opaco o ottone satinato ·
nichel mat sau bronz mat · harjattu teräs tai mattamessinki ·
nikiel mat lub mosiądz mat



08



07

500



Ø 16 cm, √ max. 63 cm
incl. 1 x SMD-LED, 6 W
560 lm, 3.000 K



272470107
272470108



↓ 43 cm, √ 50 cm
incl. 1 x SMD-LED, 6 W
560 lm, 3.000 K



572410107
572410108



↓ 120 - 140 cm, √ max. 71 cm
incl. 1 x SMD-LED, 10 W
1.000 lm, 3.000 K



422410107
422410108



07 Nickel matt · nickel mat
08 Messing matt · brass mat

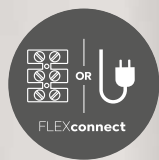

Seite/page 685

BERGAMO

Nickel matt oder Messing matt · nickel mat or brass mat ·
 nickel mat ou laiton mat · nikkell mat of messing mat ·
 níquel mate o bronze mate · nichel opaco o ottone satinato ·
 nichel mat sau bronz mat · harjattu teräs tai mattamessinki ·
 nikiel mat lub mosiądz mat



Sensordimmer · Sensor dimmer
 Variateur tactile · Touchdimmer ·
 Regulador con sensor · Touchdimmer ·
 Variator cu senzor · Kosketushimmennin ·
 Czujnik ściemniania



502



↑ 50 cm, ↗ 40 cm
 incl. 1 x SMD-LED, 12 W
 1.100 lm, 3.000 K



520910107
 520910108



↑ 135 cm, ↗ 50 cm
 incl. 1 x SMD-LED, 12 W
 1.100 lm, 3.000 K



420910107
 420910108



07 Nickel matt · nickel mat
 08 Messing matt · brass mat

VERONA

Nickel matt · nickel mat ·
nickel mat · nikkell mat · níquel mate · nichel opaco ·
nichel mat · harjattu teräs · nikiel mat



Sensordimmer · Sensor dimmer
Variateur tactile · Touchdimmer ·
Regulador con sensor · Touchdimmer ·
Variator cu senzor · Kosketushimmennin ·
Czujnik ściemniania ·

↑ 130 cm, ↗ 70 cm
incl. 1 x SMD-LED, 12 W
1.100 lm, 3.000 K



420810107

FILIGRAN

Nickel matt oder Schwarz matt · nickel mat or black mat ·
nickel mat ou noir mat · nikkel mat of mat zwart ·
níquel mate o estera negra · nichel opaco o nero opaco ·
nichel mat sau negru mat · harjattu teräs tai mattamusta ·
nikiel mat lub czarny mat

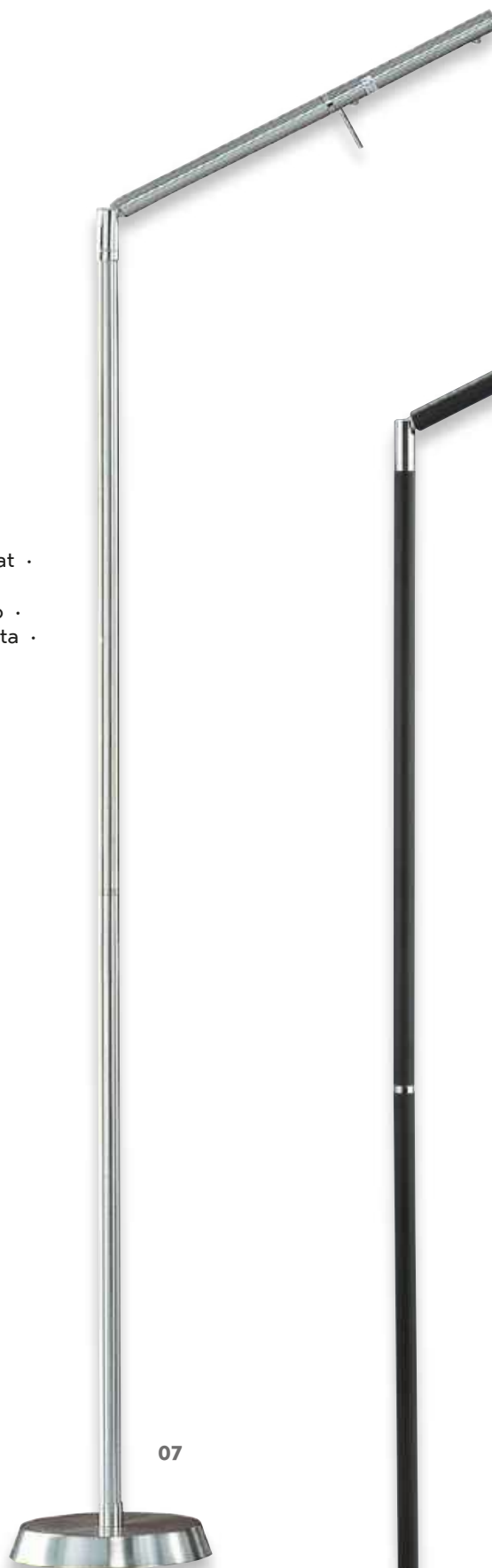

504



↑ 45 cm, ↗ 51 cm
incl. 1 x SMD-LED, 6 W
560 lm, 3.000 K



520490107



↑ 162 cm, ↗ 52 cm
incl. 1 x SMD-LED, 6 W
560 lm, 3.000 K



420490107
420490132



07 Nickel matt · nickel mat
32 Schwarz matt · black mat

NARCOS

Nickel matt, Weiß matt oder Schwarz matt ·
nickel mat, white mat or black mat ·
nickel mat, blanc mat ou noir mat ·
nikkel mat, wit mat of mat zwart ·
níquel mate, estera blanca o estera negra ·
nichel opaco, bianco opaco o nero opaco ·
nichel mat, alb mat sau negru mat ·
harjattu teräs, valkoinen matto tai musta matto ·
nikiel mat, biały mat lub czarny mat

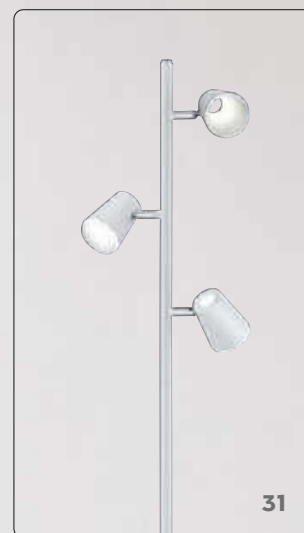

↑ 154 cm, ↔ 28 cm
incl. 3 x SMD-LED, 4,7 W
3 x 470 lm, 3.000 K



473190307
473190331
473190332



07 Nickel matt · nickel mat
31 Weiß matt · white mat
32 Schwarz matt · black mat



ICARO

Metall, Glas matt · metal, mat glass ·
metale, verre mat · metaal, mat glas ·
metal, vidrio mate · metallo, vetro sabbiato ·
metal, sticla mata · metalli, mattalasi ·
metal, szkło matowane

07



04



08

506



↑ 165 cm, ↗ 54 cm
excl. 1 x E27, max. 60 W



4035011-04
4035011-07
4035011-08



04 Altmessing · old brass
07 Nickel matt · nickel mat
08 Messing matt · brass mat

ZIDANE

Nickel matt · nickel mat ·
nickel mat · nikkell mat ·
níquel mate · nichel opaco ·
nichel mat · harjattu teräs ·
nikiel mat



↑ 145 cm, Ø 24 cm
incl. 3 x SMD-LED, 4,5 W
3 x 430 lm, 3.000 K



478610307





CANNES II

Chrom / Aluminium gebürstet, Acryl, Stoffschirm ·
chrome / brushed aluminium, acryl, fabric shade ·
chrome / aluminium balayé, acryl, abat-jour tissu · chrom / geborsteld
aluminium, acryl, Stoffen kap · cromo / aluminio pulido, acrílico, Pantalla
de tela · cromo / alluminio spazzolato, acrilico, paralume in tessuto ·
crom / aluminiu lucios, acrilic, abajur textil · kromi / harjattu alumiini,
akryyli, kangas varjostin · chrom / aluminium szczotkowane, akryl,
Klosz z materiału



Getrennt schaltbar · Separately switchable
Interrupteurs séparés · Gescheiden schakelbaar ·
Interruptores separados · Interruttori separati ·
Intrerruptoare separate · Erikseen kytkettävissä ·
Oddzielny przełącznik

509



↑ 165 cm, Ø 38 cm
incl. SMD-LED, 15,5 W
1.370 lm, 3.000 K
excl. 1 x E27, max. 60 W



422970206



TANDORI

Nickel matt, Stoff · nickel mat, fabric ·
 nickel mat, tissu · nikkell mat, textiel ·
 níquel mate, tela · nichel opaco, tessuto ·
 nichel mat, textil · harjattu teräs, tekstiili ·
 nikiel mat, tkanina

1x ——— 2x ——— 3x



Getrennt schaltbar · Separately switchable
 Interrupteurs séparés · Gescheiden schakelbaar ·
 Interruptores separados · Interruttori separati ·
 Intrerupatoare separate · Erikseen kytkettävissä ·
 Oddzielny przełącznik



↑ 53 cm, Ø 25 cm
 incl. 3 x SMD-LED, 1,8 W
 3 x 150 lm, 3.000 K
 excl. 1 x E27, max. 40 W



575410207



↑ 156 cm, Ø 40 cm
 incl. 3 x SMD-LED, 5 W
 3 x 470 lm, 3.000 K
 excl. 1 x E27, max. 40 W



475410207



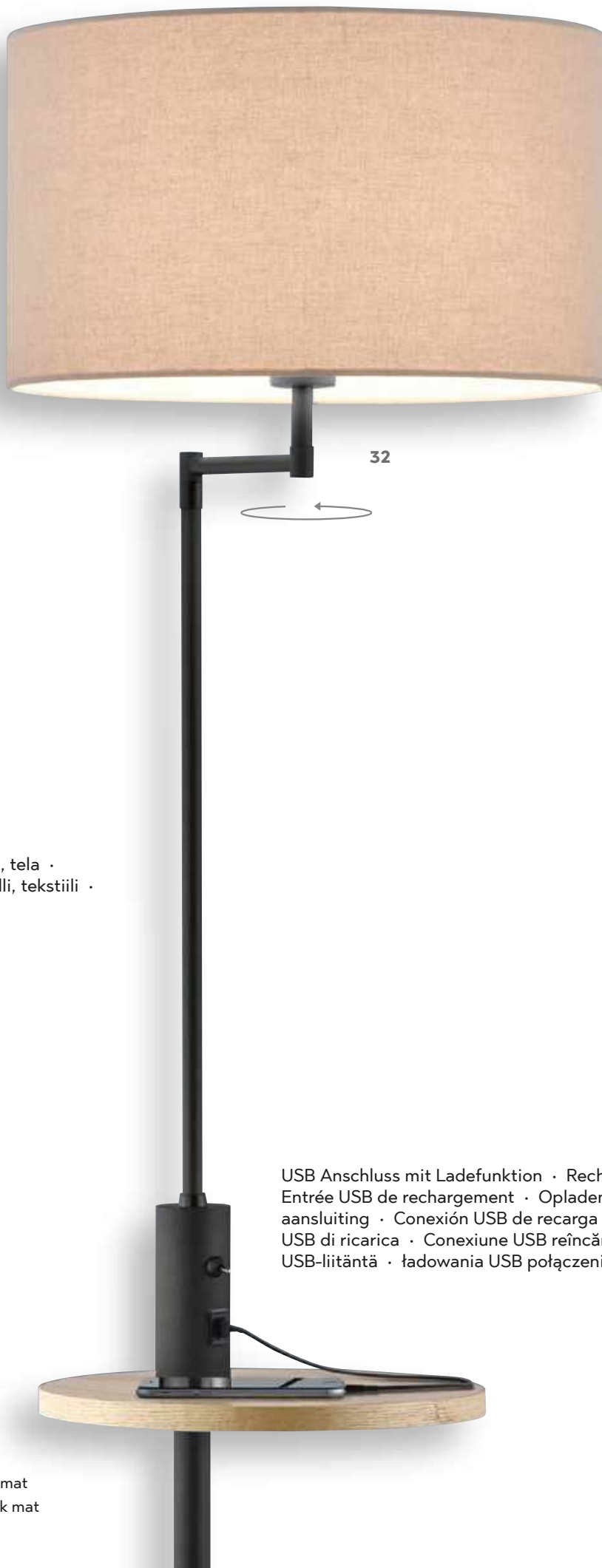

CLAAS

Metall, Stoff · metal, fabric ·
metale, tissu · metaal, textiel · metal, tela ·
metallo, tessuto · metal, textil · metalli, tekstiili ·
metal, tkanina



512



↓ 160 cm, ↔ 40 cm, ↗ 40 cm
excl. 1 x E27, max. 60 W



400400107
400400132



07 Nickel matt · nickel mat
32 schwarz matt · black mat

USB Anschluss mit Ladefunktion · Recharging USB connection ·
Entrée USB de rechargement · Opladende USB
aansluiting · Conexión USB de recarga · Connessione
USB di ricarica · Conexiune USB reîncărcare · Lataaminen
USB-liitäntä · ładowania USB połączenie



07

LIÈGE

Holz, Metall, Schwarz matt/goldfarbig · wood, metal, black mat/gold ·
bois, metale, noir mat/or · hout, metaal, mat zwart/goud ·
madera, metal, estera negra/oro · di legno, metallo, nero opaco/oro ·
lemn, metal, negru mat/aur · puu, metalli, mattamusta/kultaa ·
drewno, metal, czarny mat/złota



514



↓ 29 cm, ↔ 22,5 cm, ↗ 28 cm
excl. 1 x E14, max. 40 W



507800132



↓ 120 - 160 cm, ↔ 80 cm
excl. 1 x E27, max. 60 W



407800132

GENT

Holz, Stoffschirm, Schwarz/goldfarbig · wood, fabric shade, black/gold ·
bois, abat-jour tissu, noir/or · hout, Stoffen kap, zwart/goud ·
madera, Pantalla de tela, negro/oro · di legno, paralume in tessuto, nero/oro ·
lemn, abajur textil, negru/aur · puu, kangas varjostin, musta/kultaa ·
drewno, Klosz z materiału, czarny/złota

515



↑ 110 - 150 cm, ↔ 80 cm
excl. 1 x E27, max. 60 W



407400179



LINZ

Chrom, Stoffschirm, Schwarz/goldfarbig · chrome, fabric shade, black/gold ·
chrome, abat-jour tissu, noir/or · chrom, Stoffen kap, zwart/goud ·
cromo, Pantalla de tela, negro/oro · cromo, paralume in tessuto, nero/oro ·
crom, abajur textil, negru/aur · kromi, kangas varjostin, musta/kultaa ·
chrom, Klosz z materiału, czarny/złota

516



↓ 210 cm, ↗ 165 cm
excl. 1 x E27, max. 60 W



467400102

TEXEL

Metall Schwarz matt/goldfarbig · metal black mat/gold ·
metale noir mat/or · metaal mat zwart/goud · metal estera negra/oro ·
metallo nero opaco/oro · metal negru mat/aur · metalli musta matto/kultaa ·
metal czarny mat/złota

LED SWITCHDIMMER



↑ 47,5 cm, Ø 16 cm
incl. 1 x SMD-LED, 6,5 W
660 lm, 3.000 K



574410179



↑ 142 cm, Ø 25 cm
incl. 1 x SMD-LED, 15 W
1.450 lm, 3.000 K



474410179

31

↑ 175 cm, Ø 40 cm, ∠ max. 105 cm
excl. 1 x E27, max. 60 W



462100131
462100132



31 Weiß matt · white mat
32 Schwarz matt · black mat



32

TRACY

Metall, Stoff · metal, fabric ·
metale, tissu · metaal, textiel · metal, tela ·
metallo, tessuto · metal, textil · metalli, tekstiili ·
metal, tkanina

NANDOR

Metall, Stoff · metal, fabric ·
metale, tissu · metaal, textiel · metal, tela metallo, tessuto ·
metal, textil · metalli, tekstiili · metal, tkanina



Getrennt schaltbar · Separately switchable
Interrupteurs séparés · Gescheiden schakelbaar ·
Interruptores separados · Interruttori separati ·
Intrerupatoare separate · Erikseen kytkettävissä ·
Oddzielny przełącznik



520



↑ 62 cm, Ø 30 cm
incl. 2 x SMD, 3 W
2 x 300 lm, 3.000 K
excl. 1 x E27, max. 40 W



575310307
575310379



↑ 160 cm, Ø 40 cm
incl. 2 x SMD, 7 W
2 x 600 lm, 3.000 K
excl. 1 x E27, max. 40 W



475310307
475310379



07 Nickel matt · nickel mat
79 goldfarbig · gold





↓ 58 cm, Ø 35 cm
excl. 1 x E27, max. 60 W



500200107
500200108



↓ 160 cm, Ø 50 cm
excl. 1 x E27, max. 60 W



400200107
400200108



07 Nickel matt · nickel mat
08 Messing matt · brass mat



PARIS II

Nickel matt oder Messing matt · nickel mat or brass mat ·
nickel mat ou laiton mat · nikkell mat of messing mat ·
níquel mate o bronze mate · nichel opaco o ottone satinato ·
nichel mat sau bronz mat · harjattu teräs tai mattamessinki ·
nikiel mat lub mosiądz mat





PEREZ

Chrom, Marmor, Stoff · chrome, marble, fabric ·
chrome, marbre, tissu · chroom, marmer, textiel ·
cromo, mármol, tela · cromo, marmo, tessuto ·
crom, marmura, textil · kromi, marmori, tekstiili ·
chrom, marmur, tkanina



524



↑ 170 - 200 cm, ↗ 170 cm, Ø 50 cm
excl. 3 x E27, max. 60 W



421100301
421100302



01 Weiß · white
02 Schwarz · black



11



01

HOTEL

Nickel matt, Stoff · nickel mat, fabric ·
nickel mat, tissu · nikkel mat, textiel · níquel mate, tela ·
nichel opaco, tessuto · nichel mat, textil · harjattu teräs, tekstiili ·
nikiel mat, tkanina



↑ 170 cm, Ø 40 cm, √ 35 cm
excl. 1 x E27, max. 60 W
excl. 1 x E14, max. 18 W



403900201
403900211



01 Weiß · white
11 Grau · grey

54

LANCE

Metall, Chrom oder Schwarz, Glas rauchfarbig oder mehrfarbig ·
metal, chrome or black, glass smoke or multicolor ·
metale, chrome ou noir, verre fumé ou multicolore ·
metaal, chrom of zwart, glas rookkleur of multicolor ·
metal, cromo o negro, vidrio humo o multicolor ·
metallo, cromo o nero, vetro fume' o multicolore ·
metal, crom sau negru, sticla fumuriu sau multicolor ·
metalli, kromi tai musta, lasi savu tai monivärinen ·
metal, chrom lub czarny, szkło przydymiony lub multi-kolor



↓ 156 cm, Ø 60 cm
excl. 3 x E14, max. 28 W



403400317
403400354



17 mehrfarbig · multicolor
54 rauchfarbig · smoke





17





AMSTERDAM

Metall, Weiß oder Schwarz · metal, white or black ·
metale, blanc ou noir · metaal, wit of zwart ·
metal, blanco o negro · metallo, bianco o nero ·
metal, alb sau negru · metalli, valkoinen tai musta ·
metal, biały lub czarny

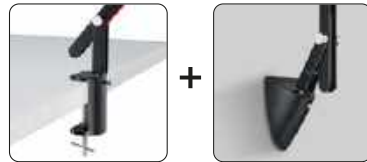

528



↑ max. 90 cm, ↗ max. 90 cm, Ø 18 cm
incl. 1 x COB-LED, 5 W
500 lm, 3.000 K



527920101
527920102



01 Weiß · white
02 Schwarz · black







NADAL

Metall, Kunststoff, Schwarz matt oder titanfarbig · metal, plastic, black mat or titan ·
 metale, plastique, noir mat ou titane · metaal, kunststof, mat zwart of titaan ·
 metal, plástico, estera negra o titán · metallo, plastica, nero opaco o titano ·
 metal, plastic, negru mat sau titaniu · metalli, muovi, mattamusta tai titaani ·
 metal, plastik, czarny mat lub tytanowy

87



+



Die Lichtfarbe (Farbtemperatur in Kelvin) ist stufenlos einstellbar · The illuminant chromaticity (colour temperature in Kelvin) is infinitely variable · la couleur de lumière (température de couleur en Kelvin) est réglable en continu · De lichtkleur (lichttemperatuur in graden Kelvin) is traploos instelbaar · El color de la luz (temperatura del color en grados Kelvin) se puede ajustar progresivamente · Il colore della luce (ovvero la sua temperatura in Kelvin) può essere regolato in modo graduale · Culoarea luminii (temperatura de culoare în Kelvin) este reglabilă în mod continuu · Valon väriä (värilämpötilaa kelvinasteina) voi säätää portaattomasti · Barwa światła (temperatura barwowa w kelwinach) może być bezstopniowo ustawiana



↑ max. 57 cm, ↔ 19 cm, ∠ max. 46 cm
 incl. SMD-LED, 6,8 W
 640 lm, 3.000 - 5.000 K



525410132
 525410187



32 Schwarz matt · black mat
87 titanfarbig · titanium-coloured





ROTTERDAM

Metall, Kunststoff, Weiß oder Anthrazit · metal, plastic, white or anthracite ·
metale, plastique, blanc ou anthracite · metaal, kunststof, wit of antraciet ·
metal, plástico, blanco o antracita · metallo, plastica, bianco o antracite ·
metal, plastic, alb sau antracit · metalli, muovi, valkoinen tai antrasiitti ·
metal, plastik, biały lub antracyt

532



+



↑ 38 cm, ↗ max. 53 cm, Ø 19 cm
incl. SMD-LED, 5 W
500 lm, 3.000 K



528020101
528020142



01 Weiß · white
42 Anthrazit · anthracite





VARIO

Metall, Kunststoff · metal, plastic ·
metale, plastique · metaal, kunststof ·
metal, plástico · metallo, plastica · metal, plastic ·
metalli, muovi · metal, plastik



87

02

534



↑ max. 64,5 cm, ↗ max. 50 cm
incl. SMD-LED, 3,6 W
200 lm, 3.000 K



522520101
522520102
522520187

01 Weiß · white
02 Schwarz · black
87 titanfarbig · titanium-coloured



GRANDE

Kunststoff, Weiß · plastic, white ·
 plastique, blanc · kunststof, wit ·
 plástico, blanco · plastica, bianco ·
 plastic, alb · muovi, valkoinen · plastik, biały



USB Anschluss mit Ladefunktion · Recharging USB connection ·
 Entrée USB de rechargement · Opladende USB
 aansluiting · Conexión USB de recarga · Connessione
 USB di ricarica · Conexiune USB reîncărcare · Lataaminen
 USB-liitäntä · ładowania USB połączenie



↑ 62 cm, ↗ 50 cm
 incl. 1 x SMD-LED, 9 W
 1.300 lm, 3.000 + 4.000 + 5.000 K



525690101

RADO

Metall, Kunststoff · metal, plastic ·
metale, plastique · metaal, kunststof ·
metal, plástico · metallo, plastica · metal, plastic ·
metalli, muovi · metal, plastik

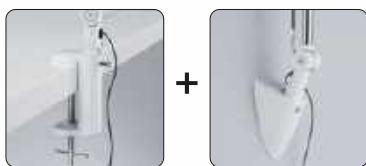

536



↑ 70 cm, ↗ 38 cm
incl. 1 x SMD-LED, 5 W
550 lm, 3.000 + 4.000 + 5.000 K



527690131
527690132



31 Weiß matt · white matt
32 Schwarz matt · black matt



RODERIC

Metall, Kunststoff · metal, plastic ·
metale, plastique · metaal, kunststof ·
metal, plástico · metallo, plastica · metal, plastic ·
metalli, muovi · metal, plastik



↓ 60 cm, ↗ 50 cm
incl. 1 x SMD-LED, 6 W
670 lm, 3.000 K



527410101
527410142



01 Weiß · white
42 Anthrazit · anthracite



LUPO

Kunststoff · plastic ·
 plastique · kunststof · plástico ·
 plastica · plastic · muovi · plastik



↑ 35 cm, Ø 13,5 cm, √ 30 cm
 incl. 1 x SMD-LED, 5 W
 550 lm, 3.500 K



527290101
 527290102



↑ 35 cm, Ø 13,5 cm, √ 30 cm
 incl. 1 x SMD-LED, 5 W
 550 lm, 3.500 K



227280101
 227280102



01 Weiß · white
 02 Schwarz · black



Grundlagen der Optik

Formeln der geometrischen Optik
dem Vergleich ähnlicher
er Darstellung der geometrischen
Abbildungswerte ergibt
Transformationsformeln der geometrischen
Abbildungswerte ergibt
D und MGP ähnlich
O und O' recht
bei M gleiche
folgende

Der Abbildungsmaßstab
Verhältnis der
der Bildgröße
sagt, in welchem
stand auf der Filmebene

Verhältnismäßig ist der Abbildungsmaßstab das Verhältnis zwischen der Abbildung und der Größe des Originals. Ein Maßstab von 1:1 würde gleich groß abgebildet. Ein Maßstab von 1:2 hingegen würde nur halb so groß abgebildet, und der Maßstab von 2:1 würde doppelt so groß abgebildet. Genau gleich groß wie das Original ist der Maßstab 1:1. Genau doppelt so groß wie das Original ist der Maßstab 2:1. Genau halb so groß wie das Original ist der Maßstab 1:2.

... bilden
... das kleinere Glied
... 1. Zwar weniger
... rechnerische Zweck
... erlaubt, ist die
... Maßstabes als

... wissen
... größer
... je kleiner die Aufnahme-
... je länger
... ist. Wenn wir
... bei gleichbleibender
... Objektivbrennweite
... mit einem Vario-Objektiv

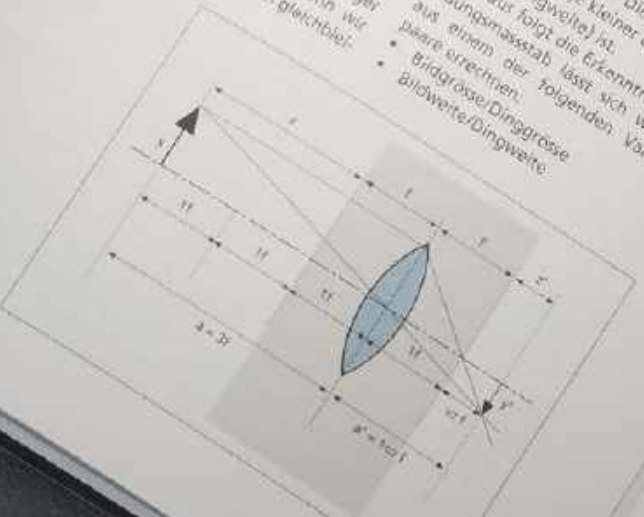

165

Aufnahmestandpunkt ein Objektiv zu erhalten, machen wir nichts anderes als die Brennweite verlängern. Weil der Bildausschnitt des Bildes dabei gleich bleibt, nehmen wir lediglich einen Ausschnitt eines mehr größeren Bildes. Die Bildgröße hängt sowohl von der Brennweite als auch von der Objektgröße ab. Aus Erfahrung und aus den bisherigen Betrachtungen wissen wir, dass der Kameraauszug (die Bildweite) gleich groß ist wie die Brennweite, wenn sich der Aufnahmegegenstand unendlich weit weg befindet. Die Bildweite wird der Aufnahmegegenstand unendlich groß (Dingweite) ist. Daraus folgt die Erkenntnis: Der Abbildungsmaßstab lässt sich wahlweise aus einem der folgenden Variablenpaare errechnen:

- Bildgröße/Dinggröße
- Bildweite/Dingweite

PRETO

Metall, Kunststoff · metal, plastic ·
 metale, plastique · metaal, kunststof ·
 metal, plástico · metallo, plastica ·
 metal, plastic · metalli, muovi ·
 metal, plastik



KOLIBRI

Metall, Kunststoff · metal, plastic ·
 metale, plastique · metaal, kunststof · metal, plástico ·
 metallo, plastica · metal, plastic · metalli, muovi ·
 metal, plastik

01

07



↑ max. 40 cm, ↗ 25 cm
 incl. SMD, 3,8 W
 350 lm, 3.100 K



528310107



↑ max. 40 cm, ↗ 40 cm
 incl. SMD, 3,8 W
 350 lm, 3.100 K



528380107



↑ 35 cm, ↗ 32 cm
 incl. 1 x SMD, 4,4 W
 450 lm, 3.000 K



527810101
 527810107



01 Weiß · white
 07 Nickel matt · nickel mat

POLO

Kunststoff · plastic ·
 plastique · kunststof ·
 plástico · plastica · plastic ·
 muovi · plastik



POLLY

Kunststoff · plastic ·
 plastique · kunststof ·
 plástico · plastica ·
 plastic · muovi ·
 plastik



↓ 41 cm, ↗ 40 cm
 incl. 1 x SMD-LED, 5 W
 550 lm, 3.000 + 4.000 + 5.000 K



527090111
 527090131



↓ 40 cm, ↔ 16 x 16 cm, ↗ 39 cm
 incl. 1 x SMD, 4,8 W
 450 lm, 3.000 K



573910101
 573910106



01 Weiß · white
06 Chrom · chrome
11 Grau · grey
31 Weiß matt · white mat



32

KIMI

Metall, Holz · metal, wood ·
metale, bois · metaal, hout · metal, madera ·
metallo, di legno · metal, lemn · metalli, puu · metal, drewno



↓ max. 50 cm, Ø 16 cm, ↗ max. 37,5 cm
excl. 1 x E27, max. 40 W



508300131
508300132



31 Weiß matt · white mat
32 Schwarz matt · black mat





31



47

TAJO

Metall · metal ·
metale · metaal · metal ·
metallo · metal · metalli · metal



01

17



↑ 73,5 cm, ↗ 51 cm
excl. 1 x E27, max. 40 W



5029010-01
5029010-17
5029010-47



01 Weiß · white
17 mehrfarbig · multicolor
47 Anthrazit · anthracite



PRONTO

Metall, Kunststoff · metal, plastic ·
 metale, plastique · metaal, kunststof ·
 metal, plástico · metallo, plastica · metal, plastic ·
 metalli, muovi · metal, plastik



FLEXO

Metall, Kunststoff · metal, plastic ·
 metale, plastique · metaal, kunststof ·
 metal, plástico · metallo, plastica ·
 metal, plastic · metalli, muovi · metal, plastik



↓ 30 cm, ↗ 22 cm
 excl. 1x E27, max. 18 W



5027011-01
 5027011-17
 5027011-47



↓ 30 cm, ↗ 30 cm
 excl. 1x E14, max. 18 W



5028010-01
 5028010-02
 5028010-17
 5028010-47



01 Weiß · white
02 Schwarz · black
17 mehrfarbig · multicolor
47 silberfarbig · silver-coloured



07

DONNA

Metall, Glas alabasterfarbig ·
 metal, alabaster-coloured glass ·
 metale, verre couleur albâtre ·
 metaal, albastkleurig glas ·
 metal, vidrio de color alabastro ·
 metallo, vetro colore alabastro ·
 metal, sticla culoare alabastru ·
 metalli, lasi alabasteri väri ·
 metal, szkło alabaster kolor



08



32



07

BERLIN

Metall, Glas matt · metal, mat glass ·
 metale, verre mat · metaal, mat glas ·
 metal, vidrio mate · metallo, vetro sabbaiato ·
 metal, sticla mata · metalli, mattalasi ·
 metal, szkło matowane · metal, mat cam



79



↑ 30 cm, Ø 22,5 cm
 incl. 1 x SMD-LED, 4 W
 350 lm, 3.000 K



525790107
 525790108
 525790132



↑ 39 cm, Ø 19,5 cm
 incl. 1 x SMD-LED, 4 W
 350 lm, 3.000 K



527590107
 527590132
 527590179



07 Nickel matt · nickel mat
 08 Messing matt · brass mat
 32 Schwarz matt · black mat
 79 goldfarbig · gold



32

547



07



04

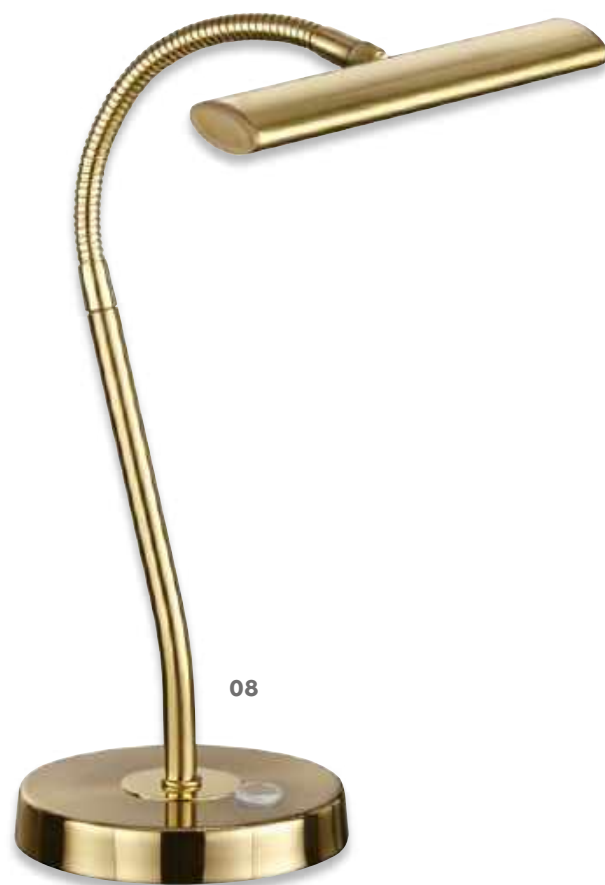

08

CURTIS

Altmessing, Nickel matt oder Messing matt ·
 old brass, nickel mat or brass mat ·
 laitton fumé, nickel mat ou laitton mat · oud brons,
 nikkell mat of messing mat · bronz viejo, níquel mate
 o bronz mate · ottone invecchiato, nichel opaco o
 ottone satinato · bronz antic, nichel mat sau bronz mat ·
 antiikkimessinki, harjattu teräs tai mattamessinki ·
 patyna, nikiel mat lubmosiãdz mat

548



↑ 35 cm, ↗ max. 18,5 cm
 incl. SMD-LED, 4 W
 380 lm, 3.000 K



579790104
 579790107
 579790108

04 Altmessing · old brass
 07 Nickel matt · nickel mat
 08 Messing matt · brass mat

EMERALD

Metall, Glas matt · metal, mat glass ·
metale, verre mat · metaal, mat glas ·
metal, vidrio mate · metallo, vetro sabbiato ·
metal, sticla mata · metalli, matalasi ·
metal, szkło matowane



07



06

549



↑ 29 cm, Ø 15 cm
incl. 1 x SMD-LED, 4 W
350 lm, 3.000 K



525490106
525490107



06 Chrom · chrome
07 Nickel matt · nickel mat



00



07

CRISTO

Chrom oder Nickel matt, Glas · chrome or nickel mat, glass ·
 chrome ou nickel mat, verre · chrom of nikkel mat, glas ·
 cromo o níquel mate, vidrio · cromo o nichel opaco, vetro ·
 crom sau nichel mat, sticla · kromi tai harjattu teräs, lasi ·
 chrom lub nikiel mat, szkło



MONTI

Metall, Glas · metal, glass ·
 metale, verre · metaal, glas ·
 metal, vidrio · metallo, vetro ·
 metal, sticla · metalli, lasi ·
 metal, szkło · metal, cam



07



MORTEN

Metall, Glas alabasterfarbig · metal, alabaster-coloured glass ·
 metale, verre couleur albâtre · metaal, albastkleurig glas ·
 metal, vidrio de color alabastro · metallo, vetro colore alabastro ·
 metal, sticla culoare alabastru · metalli, lasi alabasteri väri ·
 metal, szkło alabaster kolor



↑ 15 cm, Ø 11 cm
 incl. 1 x SMD-LED, 4,3 W
 430 lm, 3.000 K



529690100
 529690107



↑ 25,5 cm, Ø 15 cm
 incl. 1 x LED E14, 4 W
 320 lm, 3.000 K



529310107



↔ 15 x 8 cm, ↑ 18,5 cm
 excl. 1 x G9, max. 28 W



592000107



00 Transparent · transparent
 07 Nickel matt · nickel mat

JOOST

Nickel matt, Glas matt · nickel mat, mat glass ·
 nickel mat, verre mat · nikkell mat, mat glas ·
 níquel mate, vidrio mate · nichel opaco, vetro sabbiato ·
 nichel mat, sticla mata · harjattu teräs, mattalasi ·
 nikiel mat, szkło matowane



VENTURA

Metall, Glas matt · metal, mat glass ·
 metale, verre mat · metaal, mat glas ·
 metal, vidrio mate · metallo, vetro sabbiato ·
 metal, sticla mata · metalli, mattalasi ·
 metal, szkło matowane



↑ 39 cm, Ø 19 cm
 excl. 1 x E27, max. 60 W



5922011-07



↑ 28 cm, Ø 15,5 cm
 incl. 1 x SMD-LED, 4 W
 350 lm, 3.000 K



529990103
 529990107



03 Messing poliert · polished brass
 07 Nickel matt · nickel mat



HENK

Metall, Glas alabasterfarbig ·
 metal, alabaster-coloured glass ·
 metale, verre couleur albâtre ·
 metaal, albastkleurig glas ·
 metal, vidrio de color alabastro ·
 metallo, vetro colore alabastro ·
 metal, sticla culoare alabastru ·
 metalli, lasi alabasteri väri ·
 metal, szkło alabaster kolor



GERRIT

Metall, Glas alabasterfarbig ·
 metal, alabaster-coloured glass ·
 metale, verre couleur albâtre ·
 metaal, albastkleurig glas ·
 metal, vidrio de color alabastro ·
 metallo, vetro colore alabastro ·
 metal, sticla culoare alabastru ·
 metalli, lasi alabasteri väri ·
 metal, szkło alabaster kolor



↓ 38 cm, Ø 26 cm
 excl. 1 x E14, max. 40 W



5925011-07
 5925011-08



↓ 25 cm, Ø 15 cm
 excl. 1 x E14, max. 40 W



5930011-01
 5930011-24

01 Weiß · white
 07 Nickel matt · nickel mat
 08 Messing matt · brass mat
 24 rostfarbig · rusty



07



08



18



24



06

FYNN

Metall, Glas alabasterfarbig · metal, alabaster-coloured glass ·
metale, verre couleur albâtre · metaal, albastkleurig glas ·
metal, vidrio de color alabastro · metallo, vetro colore alabastro ·
metal, sticla culoare alabastru · metalli, lasi alabasteri väri ·
metal, szkło alabaster kolor



↑ 21 cm, Ø 15 cm
excl. 1 x E14, max. 40 W



599000106
599000107
599000108
599000118
599000124



06 Chrom · chrome
07 Nickel matt · nickel mat
08 Messing matt · brass mat
18 Orange · orange
24 rostfarbig · rusty



DAVI

Nickel matt, Glas matt · nickel mat, mat glass ·
 nickel mat, verre mat · nikkell mat, mat glas ·
 níquel mate, vidrio mate · nichel opaco, vetro sabbaiato ·
 nichel mat, sticla mata · harjattu teräs, mattalasi ·
 nikiel mat, szkło matowane



SETA

Nickel matt, Glas · nickel mat, glass ·
 nickel mat, verre · nikkell mat, glas ·
 níquel mate, vidrio · nichel opaco, vetro ·
 nichel mat, sticla · harjattu teräs, lasi ·
 nikiel mat, szkło



TILL

Nickel matt, Glas matt · nickel mat, mat glass ·
 nickel mat, verre mat · nikkell mat, mat glas ·
 níquel mate, vidrio mate · nichel opaco, vetro sabbaiato ·
 nichel mat, sticla mata · harjattu teräs, mattalasi ·
 nikiel mat, szkło matowane



ARY

Nickel matt, Glas matt · nickel mat, mat glass ·
 nickel mat, verre mat · nikkell mat, mat glas ·
 níquel mate, vidrio mate · nichel opaco, vetro sabbaiato ·
 nichel mat, sticla mata · harjattu teräs, mattalasi ·
 nikiel mat, szkło matowane



↓ 21 cm, Ø 8,5 cm
 incl. 1 x LED E14, 4 W
 320 lm, 3.000 K



574090107



↓ 15 cm, ↔ 10 x 15 cm
 excl. 1 x E14, max. 40 W



5901011-07



↓ 16 cm, ↔ 10 x 15 cm
 excl. 1 x E14, max. 40 W



5900011-07



↓ 15 cm, Ø 9 cm
 excl. 1 x E14, max. 40 W



5908011-07

LACAN

Chrom, Acryl · chrome, acryl ·
 chrome, acryl · chroom, acryl · cromo, acrílico ·
 cromo, acrilico · crom, acrylic · kromi, akryyli ·
 chrom, akryl



LUIS

Metall, Glas alabasterfarbig ·
 metal, alabaster-coloured glass ·
 metale, verre couleur albâtre ·
 metaal, albastkleurig glas ·
 metal, vidrio de color alabastro ·
 metallo, vetro colore alabastro ·
 metal, sticla culoare alabastru ·
 metalli, lasi alabasteri väri ·
 metal, szkło alabaster kolor



↑ 30 cm, Ø 13 cm
 excl. 1 x E14, max. 40 W



593900100



↑ 32 cm, Ø 12
 excl. 1 x E14, max. 40 W



595500106
 595500107
 595500108



00 Transparent · transparent
 06 Chrom · chrome
 07 Nickel matt · nickel mat
 08 Messing matt · brass mat



MATS

Nickel matt, Stoff · nickel mat, fabric ·
 nickel mat, tissu · nikkell mat, textiel ·
 níquel mate, tela · nichel opaco, tessuto · nichel mat, textil ·
 harjattu teräs, tekstiili · nikiel mat, tkanina



↑ 24 cm, Ø 14 cm
 excl. 1 x E14, max. 40 W



599600101
 599600102
 599600115
 599600119
 599600142



01 Weiß · white
02 Schwarz · black
15 Grün · green
19 Türkis · turquoise
42 Anthrazit · anthacite





02

01

PIET

Nickel matt, Stoff · nickel mat, fabric ·
 nickel mat, tissu · nikkell mat, textiel ·
 níquel mate, tela · nichel opaco, tessuto ·
 nichel mat, textil · harjattu teräs, tekstiili ·
 nikiel mat, tkanina



42



WIM

Chrom, Stoff · chrome, fabric ·
 chrome, tissu · chroom, textiel · cromo, tela ·
 cromo, tessuto · crom, textil · kromi, tekstiili ·
 chrom, tkanina



↓ 30 cm, Ø 15,5 cm
 excl. 1 x E14, max. 40 W



5960011-01



↓ 35,5 cm, ↔ 12 x 12 cm
 excl. 1 x E14, max. 40 W



5914011-01
 5914011-02
 5914011-42



01 Weiß · white
 02 Schwarz · black
 42 Anthrazit · anthracite



2-Phasen- Schienensystem

2-phase track system

Système de voie à deux phases

2-fase-spoorsysteem

Sistema de rieles en 2 fases

Sistema a binario bifase

Sistem de piste cu 2 faze

2-vaihekiskojärjestelmä

2-fazowy system prowadnic



Das DUOline 2-Phasen-Schiensystem ist äußerst flexibel und bietet zahlreiche Möglichkeiten zur individuellen Lichtgestaltung. Die verschiedenen Spots und Pendelleuchten lassen sich frei in der Schiene platzieren und können so gezielt in allen Wohnbereichen eingesetzt werden. Das 2-Phasensystem ermöglicht, dass mit nur einem Stromanschluss zwei Beleuchtungsgruppen getrennt voneinander geschaltet oder gedimmt werden können.

Bitte beachten! Um das 2-Phasensystem nutzen zu können, wird eine vieradrige Stromleitung benötigt.

The DUOline 2-phase track system is extremely flexible and offers numerous possibilities for individual lighting arrangements. The various spotlights and pendant lamps can be positioned as desired in the track and can therefore be used in all living areas. The 2-phase system allows two lighting groups to be switched or dimmed independently of each other with just one power connection.

Please note! A four-core power cable is required to be able to use the 2-phase system.

Le système de rails biphasés DUOline est extrêmement flexible et offre de nombreuses possibilités de conception individuelle de l'éclairage. Les différents projecteurs et luminaires suspendus peuvent être positionnés librement dans le rail et peuvent donc être utilisés de manière spécifique dans tous vos espaces d'habitation. Le système biphasé permet de commuter ou de faire varier l'intensité de deux groupes d'éclairage séparément l'un de l'autre avec un seul branchement électrique.

Attention ! Un câble d'alimentation à quatre conducteurs est nécessaire pour utiliser le système biphasé.

Het DUOline-2-fase-spoorsysteem is uiterst flexibel en biedt talrijke mogelijkheden voor een individuele lichtvormgeving. De diverse spots en hanglampen kunnen willekeurig in het spoor geplaatst worden en kunnen zo doelgericht in alle woonruimtes gebruikt worden. Het 2-fase-systeem maakt mogelijk dat met slechts één stroomaansluiting twee verlichtingsgroepen apart van elkaar geschakeld of gedimd kunnen worden.

Opgelet! Om het 2-twee-fasesysteem te kunnen gebruiken is een vierdradige stroomleiding nodig.

El sistema de rieles en 2 fases DUOline es extraordinariamente flexible y ofrece numerosas posibilidades de diseño lumínico individuales. Los distintos puntos y lámparas de péndulo le permiten colocar los rieles libremente y por eso pueden utilizarse en toda la vivienda. El sistema de rieles en 2 fases permite que se activen o atenúen dos

grupos de lámparas separados con un solo cable de corriente.

¡Por favor, recuerde! Para poder utilizar el sistema en 2 fases, será necesario un cable de corriente de cuatro filamentos.

Il sistema a binario bifase DUOline è estremamente flessibile e offre numerose possibilità per la progettazione individuale dell'illuminazione. I vari faretti e lampade a sospensione possono essere posizionati liberamente nel binario e possono quindi essere utilizzati in modo specifico in tutti gli ambienti abitativi. Il sistema bifase consente di commutare o dimmerare due gruppi di illuminazione separatamente l'uno dall'altro con una sola connessione di alimentazione.

Attenzione! Per utilizzare il sistema bifase è necessario un cavo di alimentazione a quattro conduttori.

Sistemul de piste cu 2 faze DUOline este deosebit de flexibil și oferă numeroase posibilități pentru structurarea individuală a luminii. Diferitele spot-uri și lustre pot fi amplasate liber pe pistă și pot fi astel utilizate ținut în toate zonele spațiilor de locuit. Sistemul cu 2 faze permite comutarea și reglarea intensității pentru două grupuri de corpuri de iluminat separate, folosind un singur racord electric.

Vă rugăm să aveți în vedere! Pentru a putea utiliza sistemul cu 2 faze, este necesară utilizarea unui cablu electric cu patru fire.

DUOline 2-vaihekiskojärjestelmä on erittäin joustava ja tarjoaa lukuisia vaihtoehtoja yksilölliseen valaistuksen suunnitteluun. Eri spotti- ja ripustettavat valaisimet voidaan sijoittaa mihin tahansa kiskoon, joten niitä voidaan käyttää kaikissa asuintiloissa. 2-vaihejärjestelmä mahdollistaa kahden valaistusryhmän kytkemisen tai himmentämisen erikseen yhdellä sähköliitännällä.

Huomaa! Kaksivaihejärjestelmän käyttämiseksi tarvitaan nelijohtiminen sähkönsyöttö.

Dwufazowy system przewodnic DUOline jest niezwykle elastyczny i oferuje wiele opcji indywidualnego projektowania oświetlenia. Różne skupienia i lampy wiszące można umieścić w dowolnym miejscu na szynie, dzięki czemu można je stosować we wszystkich pomieszczeniach mieszkalnych. System 2-fazowy umożliwia osobne przełączanie lub przyciemnianie dwóch grup oświetlenia za pomocą tylko jednego podłączenia zasilania.

Proszę pamiętać! Dla korzystania z systemu 2-fazowego, wymagana jest czteroprzewodowa linia zasilania.

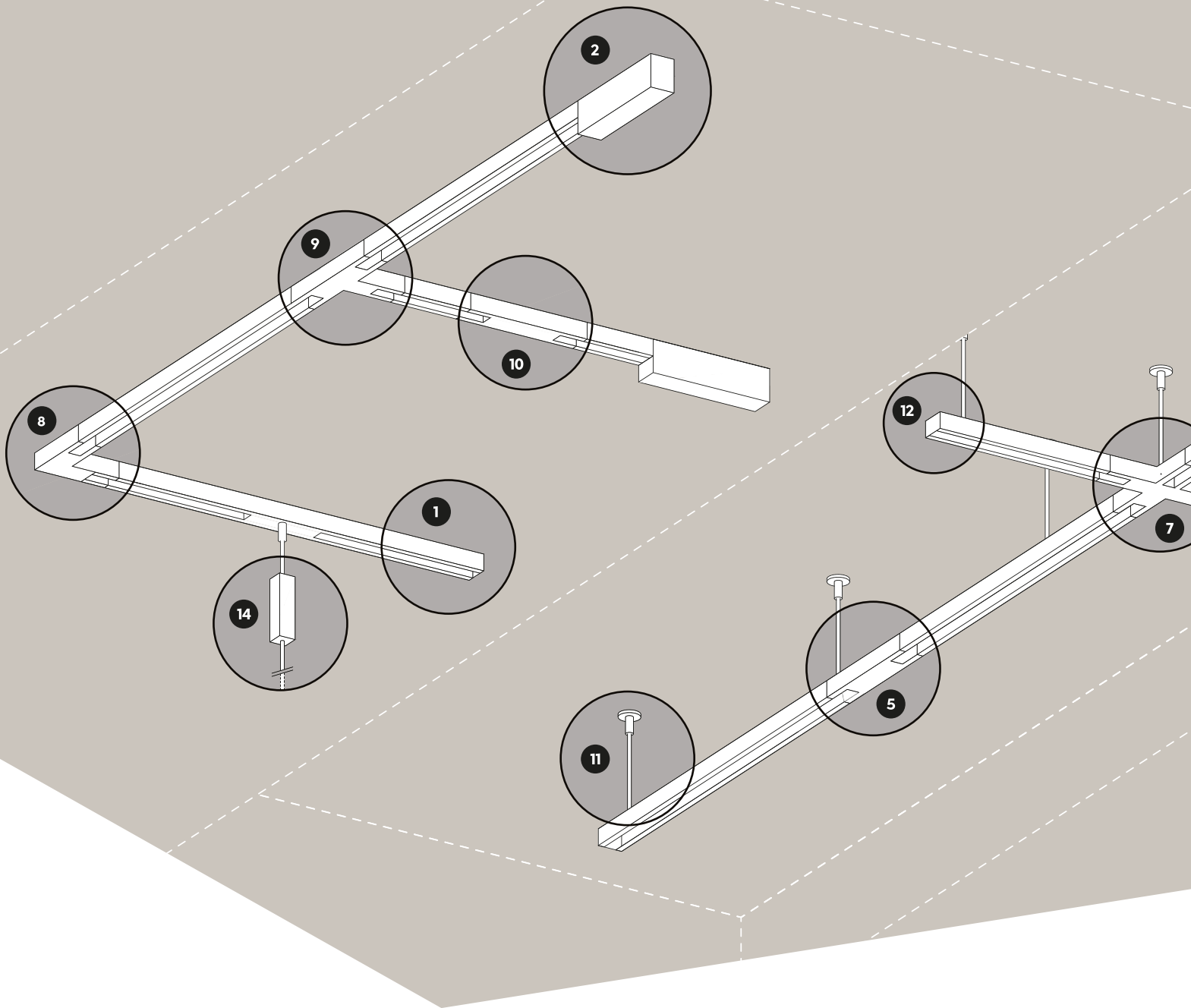

Die Vorteile von DUOLINE im Überblick:

- Individuelle Lichtgestaltung
- Nur ein Stromanschluss erforderlich
- Kein Trafo notwendig
- Leuchten frei kombinierbar und leicht versetzbar
- Zwei verschiedene Lichtszenarien
- Getrenntes Schalten und Dimmen
- Für Decken- und Wandmontage geeignet

Bei der Planung bitte unbedingt die Position des Schutzleiters beachten, der innerhalb des Systems durchgängig verbunden sein muss.

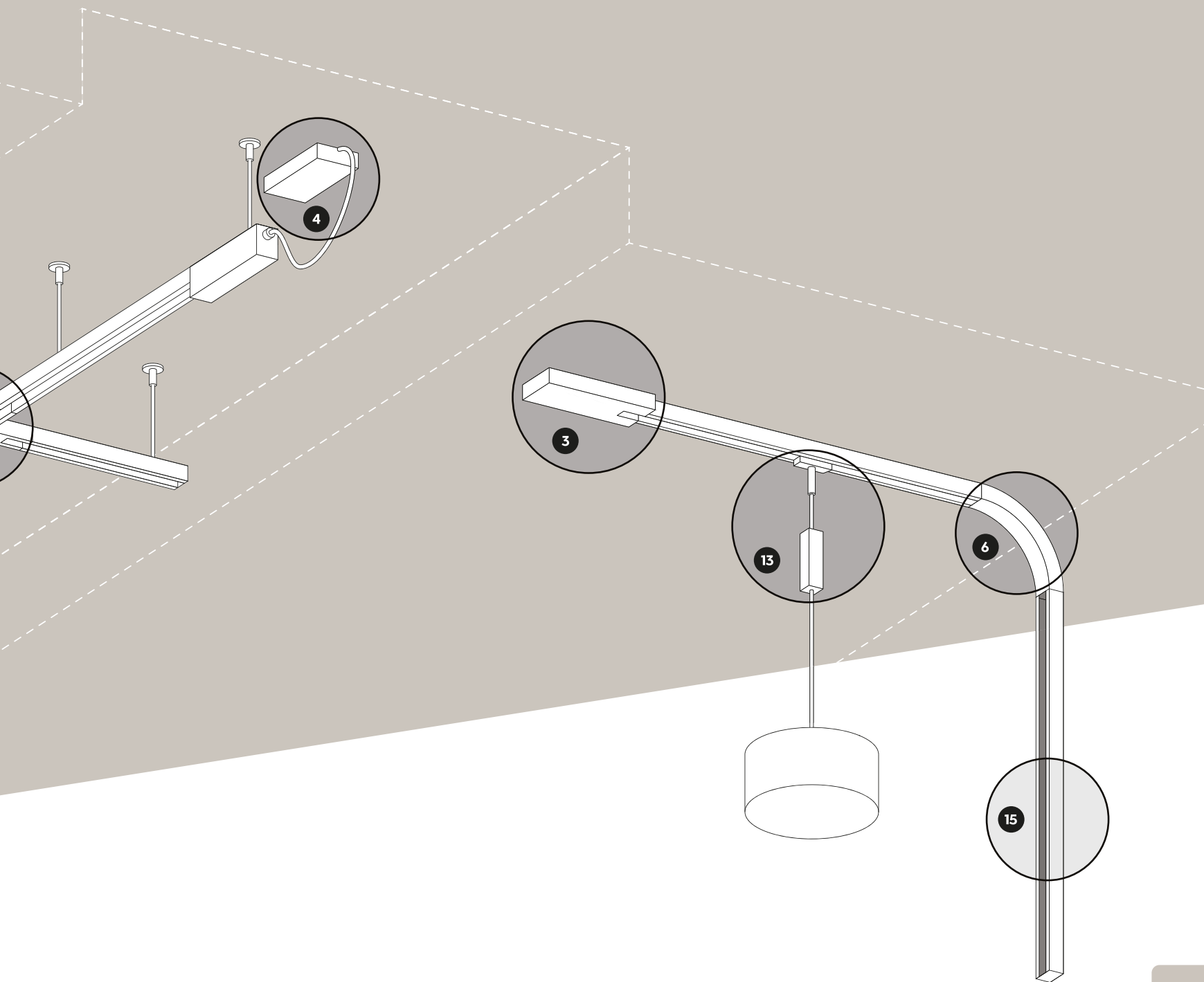

Advantages of DUOLine at a glance:

- individual lighting arrangements
- only one power connection required
- no need for a transformer
- lamps can be freely combined and are easily positioned
- two different lighting scenarios
- separate switching and dimming
- suitable for ceilings and walls

When planning, please pay attention to the position of the protective conductor, which must be connected continuously within the system.



SCHIENE · TRACK

1 SCHIENE TRACKING

Die maximale
Montagelänge beträgt
30 Meter pro Einspeisung,
bei einer Gesamtleistung von
max. 600 Watt pro Phase.

*The maximum
installation length is
30 metres per power feed,
with a total capacity of
max. 600 watts per phase.*



700131
Metall · metal
Weiß matt · white mat
max. 2 x 600 W
↔ 50 x 3 cm, ↓ 2 cm



700132
Metall · metal
Schwarz matt · black mat
max. 2 x 600 W
↔ 50 x 3 cm, ↓ 2 cm



700187
Metall · metal
titanfarbig · titan
max. 2 x 600 W
↔ 50 x 3 cm, ↓ 2 cm



700231
Metall · metal
Weiß matt · white mat
max. 2 x 600 W
↔ 100 x 3 cm, ↓ 2 cm



700232
Metall · metal
Schwarz matt · black mat
max. 2 x 600 W
↔ 100 x 3 cm, ↓ 2 cm



700287
Metall · metal
titanfarbig · titan
max. 2 x 600 W
↔ 100 x 3 cm, ↓ 2 cm

EINSPEISUNG · POWER SUPPLY

2 MITTEL-/END-EINSPEISUNG

MIDDLE-/ENDPOINT POWER SUPPLY



701031

Kunststoff · plastic
Weiß matt · white mat
max. 2 x 600 W
↔ 13,5 x 3 cm, ↓ 5 cm



701032

Kunststoff · plastic
Schwarz matt · black mat
max. 2 x 600 W
↔ 13,5 x 3 cm, ↓ 5 cm



701087

Kunststoff · plastic
titanfarbig · titan
max. 2 x 600 W
↔ 13,5 x 3 cm, ↓ 5 cm

Die Mittel-/Endeinspeisung wird direkt über dem Stromauslass angebracht und ermöglicht, Schienen auf einer Seite oder auf beiden Seiten anzuschließen.

The middle/end feed is mounted directly over the power outlet and enables tracks to be connected on one or both sides.

3 MITTEL-/END-EINSPEISUNG MIT ELEKTRONISCHEM PHASENWECHSLER

MIDDLE-/ENDPOINT POWER SUPPLY WITH ELECTRONIC PHASE CHANGER



701131

Kunststoff · plastic
Weiß matt · white mat
max. 2 x 200 W
↔ 13,5 x 9,5 cm, ↓ 5 cm



701132

Kunststoff · plastic
Schwarz matt · black mat
max. 2 x 200 W
↔ 13,5 x 9,5 cm, ↓ 5 cm



701187

Kunststoff · plastic
titanfarbig · titan
max. 2 x 200 W
↔ 13,5 x 9,5 cm, ↓ 5 cm

Mittels elektronischem Phasenwechsler lassen sich die zwei Phasen auch bei dreiadrigen Stromleitungen getrennt Schalten und Dimmen.

Using an electronic phase changer, the two phases can be switched and dimmed separately, even with three-core power cables.

4 FLEXIBLE STROMVERSORGUNG

FLEX POWER SUPPLY



701231

Kunststoff · plastic
Weiß matt · white mat
max. 2 x 600 W
↔ 13,5 x 9,5 cm, ↓ 3 cm



701232

Kunststoff · plastic
Schwarz matt · black mat
max. 2 x 600 W
↔ 13,5 x 9,5 cm, ↓ 3 cm



701287

Kunststoff · plastic
titanfarbig · titan
max. 2 x 600 W
↔ 13,5 x 9,5 cm, ↓ 3 cm

Die flexible Stromversorgung wird benötigt, wenn die Schienen nicht direkt über den Stromauslass verlegt werden können.

The flexible power supply is required if the rails cannot be mounted directly over the power outlet.

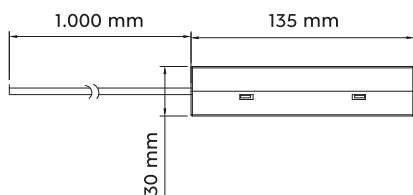

VERBINDER · CONNECTOR

5 LÄNGSVERBINDER

LINE CONNECTOR

Verbindet zwei Schienen für gerade Strecken miteinander.

Connects two rails together for straight sections.



702131

Kunststoff · plastic
Weiß matt · white mat
max. 2 x 600 W
↔ 9,5 x 3 cm, ↑ 2 cm



702132

Kunststoff · plastic
Schwarz matt · black mat
max. 2 x 600 W
↔ 9,5 x 3 cm, ↑ 2 cm



702187

Kunststoff · plastic
titanfarbig · titan
max. 2 x 600 W
↔ 9,5 x 3 cm, ↑ 2 cm

6 FLEX-VERBINDER

FLEX CONNECTOR

Verbindet zwei Schienen in einem beliebigen Winkel miteinander und ermöglicht die Verbindung zwischen Decken- und Wandmontage.

Connects two rails together at any angle and makes possible a connection between ceiling and wall mounting.



702031

Kunststoff · plastic
Weiß matt · white mat
max. 2 x 600 W
↔ 33 x 3 cm, ↑ 2 cm



702032

Kunststoff · plastic
Schwarz matt · black mat
max. 2 x 600 W
↔ 33 x 3 cm, ↑ 2 cm



702087

Kunststoff · plastic
titanfarbig · titan
max. 2 x 600 W
↔ 33 x 3 cm, ↑ 2 cm

7 X-VERBINDER

X-CONNECTOR

Verbindet vier Schienen im rechten Winkel miteinander.

Connects four tracks together at right angles to each other.



702431

Kunststoff · plastic
Weiß matt · white mat
max. 2 x 600 W
↔ 16 x 17 cm, ↑ 2 cm



702432

Kunststoff · plastic
Schwarz matt · black mat
max. 2 x 600 W
↔ 16 x 17 cm, ↑ 2 cm



702487

Kunststoff · plastic
titanfarbig · titan
max. 2 x 600 W
↔ 16 x 17 cm, ↑ 2 cm

8 L-VERBINDER - SCHUTZLEITER INNEN

L-CONNECTOR - INNER PROTECTIVE CONDUCTOR



702231

Kunststoff · plastic
Weiß matt · white mat
max. 2 x 600 W
↔ 10 x 9 cm, ↓ 2 cm



702232

Kunststoff · plastic
Schwarz matt · black mat
max. 2 x 600 W
↔ 10 x 9 cm, ↓ 2 cm



702287

Kunststoff · plastic
titanfarbig · titan
max. 2 x 600 W
↔ 10 x 9 cm, ↓ 2 cm

L-VERBINDER (TYP A) - SCHUTZLEITER AUSSEN

L-CONNECTOR (TYPE A) - OUTER PROTECTIVE CONDUCTOR



702231A

Kunststoff · plastic
Weiß matt · white mat
max. 2 x 600 W
↔ 10 x 9 cm, ↓ 2 cm



702232A

Kunststoff · plastic
Schwarz matt · black mat
max. 2 x 600 W
↔ 10 x 9 cm, ↓ 2 cm



702287A

Kunststoff · plastic
titanfarbig · titan
max. 2 x 600 W
↔ 10 x 9 cm, ↓ 2 cm

9 T-VERBINDER - SCHUTZLEITER RECHTS

T-CONNECTOR - RIGHT PROTECTIVE CONDUCTOR



702331

Kunststoff · plastic
Weiß matt · white mat
max. 2 x 600 W
↔ 10 x 16 cm, ↓ 2 cm



702332

Kunststoff · plastic
Schwarz matt · black mat
max. 2 x 600 W
↔ 10 x 16 cm, ↓ 2 cm



702387

Kunststoff · plastic
titanfarbig · titan
max. 2 x 600 W
↔ 10 x 16 cm, ↓ 2 cm

T-VERBINDER (TYP A) - SCHUTZLEITER LINKS

T-CONNECTOR (TYPE A) - LEFT PROTECTIVE CONDUCTOR



702331A

Kunststoff · plastic
Weiß matt · white mat
max. 2 x 600 W
↔ 10 x 16 cm, ↓ 2 cm



702332A

Kunststoff · plastic
Schwarz matt · black mat
max. 2 x 600 W
↔ 10 x 16 cm, ↓ 2 cm



702387A

Kunststoff · plastic
titanfarbig · titan
max. 2 x 600 W
↔ 10 x 16 cm, ↓ 2 cm

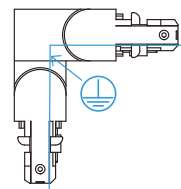

Verbindet zwei Schienen im rechten Winkel miteinander.
Connects two rails together at right angles.

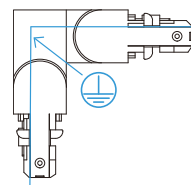

Bei der Planung bitte unbedingt die Position des Schutzleiters beachten, der innerhalb des Systems durchgängig verbunden sein muss.
When planning, please pay attention to the position of the protective conductor, which must be connected continuously within the system.

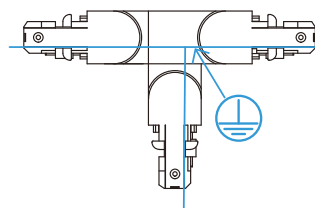

Verbindet drei Schienen im rechten Winkel miteinander.
Connects three tracks at right angles to each other.

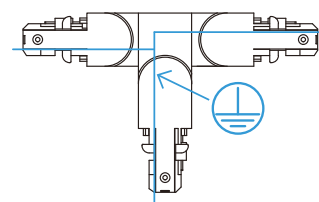

Mittels Isolator können zwei separate Schaltkreise optisch zu einem System verbunden werden.

Using an isolator, two separate circuits can be optically connected to form one system.

10 ISOLATOR

ISOLATOR



702531
Kunststoff · plastic
Weiß matt · white mat
max. 2 x 600 W
↔ 9,6 x 3 cm, ↑ 2 cm



702532
Kunststoff · plastic
Schwarz matt · black mat
max. 2 x 600 W
↔ 9,6 x 3 cm, ↑ 2 cm



702587
Kunststoff · plastic
titanfarbig · titan
max. 2 x 600 W
↔ 9,6 x 3 cm, ↑ 2 cm

11 DISTANZHALTER SET

SUSPENSION SET



703131
Metal · metal
Weiß matt · white mat
↓ 12,5 cm, Ø 2,3 cm



703132
Metal · metal
Schwarz matt · black mat
↓ 12,5 cm, Ø 2,3 cm



703187
Metal · metal
titanfarbig · titan
↓ 12,5 cm, Ø 2,3 cm



703231
Metal · metal
Weiß matt · white mat
↓ 25 cm, Ø 2,3 cm



703232
Metal · metal
Schwarz matt · black mat
↓ 25 cm, Ø 2,3 cm



703287
Metal · metal
titanfarbig · titan
↓ 25 cm, Ø 2,3 cm

12 ENDKAPPEN

END CAPS



703031
Kunststoff · plastic
Weiß matt · white mat
↔ 3 cm, ↑ 2 cm, ↗ 1,8 cm



703032
Kunststoff · plastic
Schwarz matt · black mat
↔ 3 cm, ↑ 2 cm, ↗ 1,8 cm



703087
Kunststoff · plastic
titanfarbig · titan
↔ 3 cm, ↑ 2 cm, ↗ 1,8 cm

13 PENDEL-ADAPTER

PENDULAR ADAPTER



703531

Kunststoff · plastic
Weiß matt · white mat
max. 60 W
↓ 30 cm, ↔ 3 cm



703532

Kunststoff · plastic
Schwarz matt · black mat
max. 60 W
↓ 30 cm, ↔ 3 cm



703587

Kunststoff · plastic
titanfarbig · titan
max. 60 W
↓ 30 cm, ↔ 3 cm

14 KABELKÜRZER

CABLE SHORTENER



703331

Kunststoff · plastic
Weiß matt · white mat
↔ 3 cm, ↓ 13,5 cm, ↗ 3 cm



703332

Kunststoff · plastic
Schwarz matt · black mat
↔ 3 cm, ↓ 13,5 cm, ↗ 3 cm



703387

Kunststoff · plastic
titanfarbig · titan
↔ 3 cm, ↓ 13,5 cm, ↗ 3 cm

15 ABDECKSCHIENE

SAFETY COVER STRIP



703952

Kunststoff · plastic
Transparent · transparent
↔ 100 cm, ↗ 1,4 cm

ABDECKPLATTE

COVER PLATE



703431

Metall · metal
Weiß matt · white mat
↓ 0,1 cm, Ø 10mm

Dieser Pendel-Adapter ermöglicht es, herkömmliche Pendelleuchten in das DUOline Schienensystem zu integrieren.

This pendular adapter makes it possible for conventional pendular lamps to be integrated into the DUOline track system.



Ermöglicht das Kürzen der Kabel von Pendelleuchten.

Makes a shortening of the pendular lamp cable possible.

569

HOTEL



76390201

Stoff, Weiß · fabric, white
excl. 2 x E27, max. 25 W
↑ 16,3 cm, Ø 30 cm



76390211

Stoff, Grau · fabric, grey
excl. 2 x E27, max. 25 W
↑ 16,3 cm, Ø 30 cm



73330101

Stoff, Weiß · fabric, white
excl. 1 x E27, max. 25 W
↑ 180 cm, Ø 40 cm



73330111

Stoff, Grau · fabric, grey
excl. 1 x E27, max. 25 W
↑ 180 cm, Ø 40 cm



TOMMY



78330101

Stoff, Weiß · fabric, white
excl. 1 x E14, max. 25 W
↔ 16 x 12 cm, ↓ 22 cm



78330179

Stoff, goldfarbig · fabric, gold
excl. 1 x E14, max. 25 W
↔ 16 x 12 cm, ↓ 22 cm



78330111

Stoff, Grau · fabric, grey
excl. 1 x E14, max. 25 W
↔ 16 x 12 cm, ↓ 22 cm

LEON



78070131

Metall, Weiß matt ·
metal, white mat
excl. 1 x GU10, max. 25 W
↔ 13 x 11 cm, ↓ 20 cm



78070132

Metall, Schwarz matt ·
metal, black mat
excl. 1 x GU10, max. 25 W
↔ 13 x 11 cm, ↓ 20 cm



78070107

Metall, Nickel matt ·
metal, nickel mat
excl. 1 x GU10, max. 25 W
↔ 13 x 11 cm, ↓ 20 cm

DIALLO



78010131

Metall, Weiß matt ·
metal, white mat
excl. 1 x E27, max. 40 W
↔ 10 x 4,2 cm, ↓ 12 cm



78010132

Metall, Schwarz matt ·
metal, black mat
excl. 1 x E27, max. 40 W
↔ 10 x 4,2 cm, ↓ 12 cm



78010107

Metall, Nickel matt ·
metal, nickel mat
excl. 1 x E27, max. 40 W
↔ 10 x 4,2 cm, ↓ 12 cm

MARLEY



78240131

Metall, Weiß matt ·
metal, white mat
excl. 1 x GU10, max. 25 W
↔ 10,2 cm, ↓ 16 cm, ↗ 6 cm



78240132

Metall, Schwarz matt ·
metal, black mat
excl. 1 x GU10, max. 25 W
↔ 10,2 cm, ↓ 16 cm, ↗ 6 cm



78240107

Metall, Nickel matt ·
metal, nickel mat
excl. 1 x GU10, max. 25 W
↔ 10,2 cm, ↓ 16 cm, ↗ 6 cm

MARLEY



73240131

Metall, Weiß matt ·
metal, white mat
excl. 1 x GU10, max. 25 W
↓ 180 cm, Ø 6 cm



73240132

Metall, Schwarz matt ·
metal, black mat
excl. 1 x GU10, max. 25 W
↓ 180 cm, Ø 6 cm



73240107

Metall, Nickel matt ·
metal, nickel mat
excl. 1 x GU10, max. 25 W
↓ 180 cm, Ø 6 cm

ANTIBES



78170107

Metall, Nickel matt, Glas Weiß ·
metal, nickel mat, white glass
excl. 1 x E14, max. 25 W
↔ 14 x 9 cm, ↓ 16 cm

JIMMY



73120102

Metall, Schwarz · metal, black
excl. 1 x E27, max. 25 W
↓ 180 cm, Ø 31 cm

ONTARIO



73520101

Glas, Weiß · glass, white
excl. 1 x E14, max. 25 W
↓ 180 cm, Ø 20 cm

LED-PANEL



77020131

Kunststoff, Weiß matt ·
plastic, white mat
incl. SMD-LED, 6 W
850 lm, 3.000 K
↔ 50,5 x 3 cm, ↑ 2,9 cm



77020132

Kunststoff, Schwarz matt ·
plastic, black mat
incl. SMD-LED, 6 W
850 lm, 3.000 K
↔ 50,5 x 3 cm, ↑ 2,9 cm



77020187

Kunststoff, titanfarbig ·
plastic, titan
incl. SMD-LED, 6 W
850 lm, 3.000 K
↔ 50,5 x 3 cm, ↑ 2,9 cm







Spotserien

Spots
Spotterie
Spots
Focos
Faretti
Spoturi
Spotit
Reflektorki

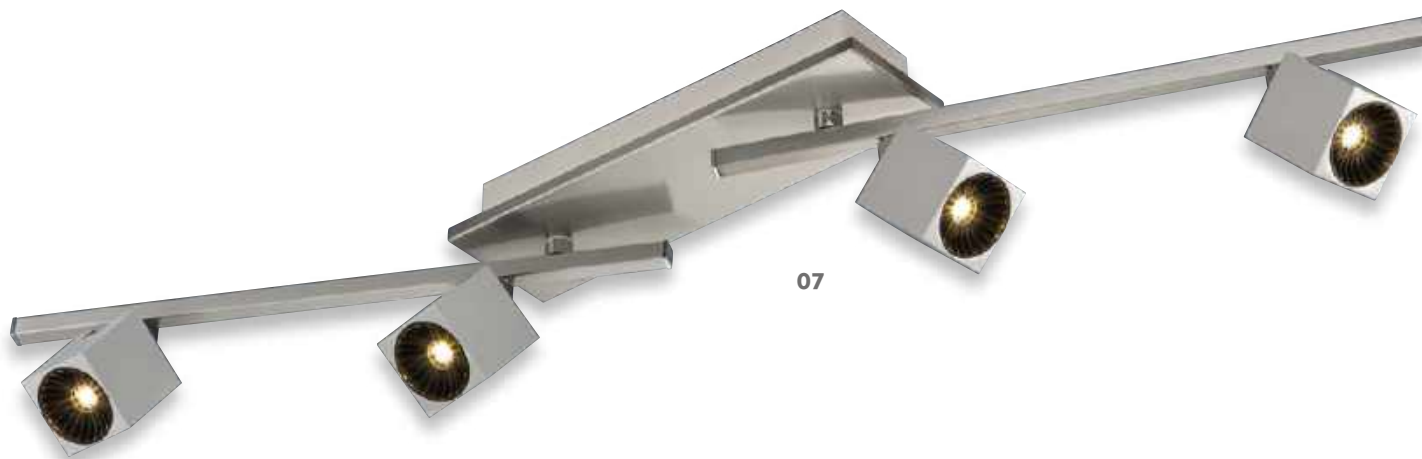

07

CUBA

Nickel matt oder Weiß matt · nickel mat or white mat ·
 nickel mat ou blanc mat · nikkell mat of wit mat ·
 níquel mate o estera blanca · nichel opaco o bianco opaco ·
 nichel mat sau alb mat · harjattu teräs tai valkoinen matto ·
 nikiel mat lub biały mat

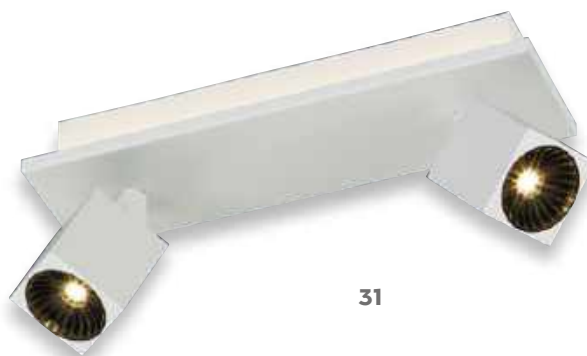

31



1x

2x

3x



Getrennt schaltbar · Separately switchable
 Interrupteurs séparés · Gescheiden schakelbaar ·
 Interruptores separados · Interruttori separati ·
 Intreruptoare separate · Erikseen kytkettävissä ·
 Oddzielny przełącznik



↔ 10 x 15 cm, ↗ 15 cm
 incl. 1 x SMD-LED, 4,3 W
 430 lm, 3.000 K
 incl. 1 x SMD, 3 W
 280 lm, 3.000 K

↔ 30 x 8,5 cm, ↑ 14 cm
 incl. 2 x SMD-LED, 4,3 W
 2 x 430 lm, 3.000 K
 incl. 1 x SMD, 4 W
 330 lm, 3.000 K

↔ 55 x 8,5 cm, ↑ 15,5 cm
 incl. 3 x SMD-LED, 4,3 W
 3 x 430 lm, 3.000 K
 incl. 1 x SMD, 8 W
 640 lm, 3.000 K

↔ 86 x 8,5 cm, ↑ 18 cm
 incl. 4 x SMD-LED, 4,3 W
 4 x 430 lm, 3.000 K
 incl. 1 x SMD, 8 W
 640 lm, 3.000 K

↔ 28 x 28 cm, ↑ 14 cm
 incl. 4 x SMD-LED, 4,3 W
 4 x 430 lm, 3.000 K
 incl. 1 x SMD, 8 W
 640 lm, 3.000 K



828570207
 828570231

828510307
 828510331

828510407
 828510431



828510507
 828510531

828530507
 828530531



577



07 Nickel matt · nickel mat
31 Weiß matt · white mat



CLAPTON

Aluminium gebürstet, Chrom, Glas Weiß gewischt ·
 brushed aluminium, chrome, glass white brushed glass ·
 aluminium balayé, chrome, verre blanc balayé ·
 geborsteld aluminium, chrom, wit geborsteld glas ·
 aluminio pulido, cromo, blanco pulido · alluminio
 spazzolato, cromo, vetro bianco spazzolato · aluminiu
 lucios, crom, alb lucios · harjattu alumiini, kromi,
 lasi harjattu valkoinen · aluminium szczotkowane, chrom,
 szkło białe otarła



578



↑ 20 x 7 cm, ↗ 16 cm
 incl. 1 x SMD-LED, 4,3 W
 430 lm, 3.000 K



821470105



↔ 36 x 7 cm, ↑ 18,5 cm
 incl. 2 x SMD-LED, 4,3 W
 2 x 430 lm, 3.000 K



821470205



↔ 50 x 7 cm, ↑ 18,5 cm
 incl. 3 x SMD-LED, 4,3 W
 3 x 430 lm, 3.000 K

821410305



↔ 96,5 x 8 cm, ↑ 18,5 cm
 incl. 4 x SMD-LED, 4,3 W
 4 x 430 lm, 3.000 K



821410405



↔ max.150 x 8 cm, ↑ 24 cm
 incl. 6 x SMD-LED, 4,3 W
 6 x 430 lm, 3.000 K

821410605



↔ 31 x 22 cm, ↑ 18,5 cm
incl. 4 x SMD-LED, 4,3 W
4 x 430 lm, 3.000 K

821430405

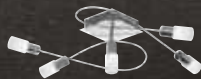

↔ 70 x 50 cm, ↑ 23 cm
incl. 5 x SMD-LED, 4,3 W
5 x 430 lm, 3.000 K

621410505



NARCOS

Nickel matt · nickel mat ·
 nickel mat · nikkel mat · níquel mate · nichel opaco ·
 nichel mat · harjattu teräs · nikiel mat



580



↓ 12 x 7,5 cm, ↗ 16 cm
 incl. SMD-LED, 6 W
 550 lm, 3.000 K



873170107



↔ 28,5 x 9,5 cm, ↗ 16 cm
 incl. 2 x SMD-LED, 6 W
 2 x 550 lm, 3.000 K



873170207



↔ 45 x 9,5 cm, ↓ 16 cm
 incl. 3 x SMD-LED, 6 W
 3 x 550 lm, 3.000 K

873110307



↔ 81,5 x 8 cm, ↓ 20 cm
 incl. 4 x SMD-LED, 6 W
 4 x 550 lm, 3.000 K



873110407



↔ 177 x 10 cm, ↓ 23 cm
 incl. 6 x SMD-LED, 6 W
 6 x 550 lm, 3.000 K

873110607



↑ 38 cm, ↗ 23 cm
incl. SMD-LED, 4,7 W
470 lm, 3.000 K



573190107



↑ 154 cm, ↔ 28 cm
incl. 3 x SMD-LED, 4,7 W
3 x 470 lm, 3.000 K



473190307



NARCOS

Wei matt · white mat ·
blanc mat · wit mat · blanco mate · bianco opaco ·
alb mat · valkoinen teräs · biały mat



↑ 12 x 7,5 cm, ↗ 16 cm
incl. SMD-LED, 6 W
550 lm, 3.000 K



873170131



↔ 28,5 x 9,5 cm, ↗ 16 cm
incl. 2 x SMD-LED, 6 W
2 x 550 lm, 3.000 K



873170231



↔ 45 x 9,5 cm, ↑ 16 cm
incl. 3 x SMD-LED, 6 W
3 x 550 lm, 3.000 K

873110331



↔ 81,5 x 8 cm, ↓ 20 cm
incl. 4 x SMD-LED, 6 W
4 x 550 lm, 3.000 K



873110431



↔ 177 x 10 cm, ↓ 23 cm
incl. 6 x SMD-LED, 6 W
6 x 550 lm, 3.000 K

873110631



↑ 154 cm, ↔ 28 cm
incl. 3 x SMD-LED, 4,7 W
3 x 470 lm, 3.000 K



473190331



↑ 38 cm, ↗ 23 cm
incl. SMD-LED, 4,7 W
470 lm, 3.000 K



573190131



↑ 13 x 13 cm, ↗ 16 cm
incl. 1 x SMD, 8 W
730 lm, 3.000 K

↔ 30 x 9 cm, ↗ 16 cm
incl. 2 x SMD, 6 W
2 x 550 lm, 3.000 K

↔ 45 x 9 cm, ↗ 16 cm
incl. 3 x SMD, 6 W
3 x 550 lm, 3.000 K

↔ 26 x 25 cm, ↓ 16 cm
incl. 4 x SMD, 6 W
4 x 550 lm, 3.000 K

↓ 154 cm, ↔ 28 cm
incl. 3 x SMD, 4,7 W
3 x 470 lm, 3.000 K



827890131
827890132

827890231
827890232

827890331
827890332

827830431
827830432

427890331
427890332

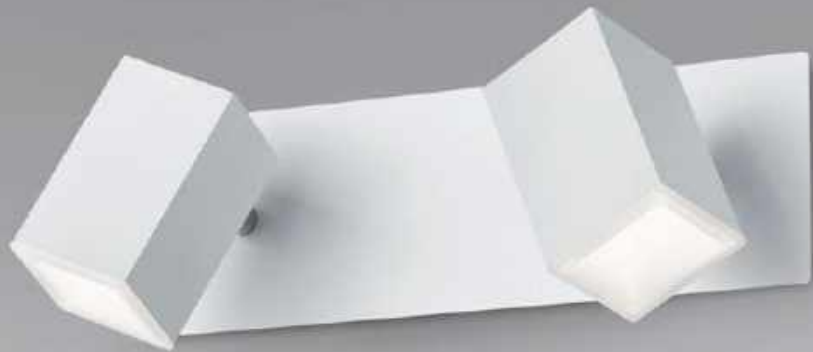

LAGOS

Metall, Acryl · metal, acryl ·
metale, acryl · metaal, acryl · metal, acrílico ·
metallo, acrilico · metal, acrilic · metalli, akryyli ·
metal, akryl

LED SWITCHDIMMER



- 31** Weiß matt · white mat
- 32** Schwarz matt · black mat



PILATUS

Chrom, Acryl · chrome, acryl ·
 chrome, acryl · chrom, acryl · cromo, acrílico · cromo, acrilico · crom, acrilic ·
 kromi, akryyli · chrom, akryl · krom, akrilik



SHARK

Nickel matt, Acryl · nickel mat, acryl ·
 nickel mat, acryl · nikkel mat, acryl · níquel mate, acrílico · nichel opaco, acrilico ·
 nichel mat, acrilic · harjattu teräs, akryyli · nikiel mat, akryl · mat nikel, akrilik



↔ max. 500 x 13,5 cm
 incl. 5 x SMD-LED, 3,8 W
 5 x 350 lm, 3.000 K

↔ max. 700 x 13,5 cm
 incl. 7 x SMD-LED, 2,5 W
 7 x 245 lm, 3.000 K

775910506

779310707





588

AVIGNON

Chrom, Acryl · chrome, acryl ·
chrome, acryl · chroom, acryl · cromo, acrílico ·
cromo, acrílico · crom, acrilic · kromi, akryyli ·
chrom, akryl

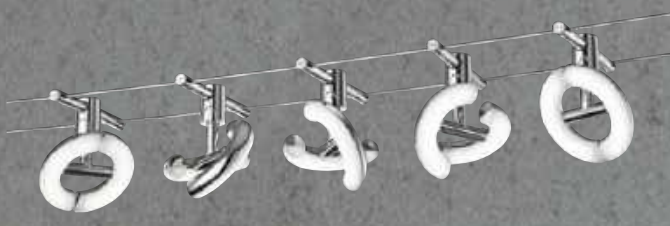

↔ max. 500 x 13 cm
incl. 5 x SMD-LED, 4,1 W
5 x 330 lm, 3.000 K

777710506



BASIC

titanfarbig · titan ·
 titane · titaan · titán · titano ·
 titaniu · titaani · tytanowy



BALOUBET

Chrom, Acryl · chrome, acryl ·
 chrome, acryl · chroom, acryl · cromo, acrílico ·
 cromo, acrilico · crom, acrilic · kromi, akryyli ·
 chrom, akryl



↔ max. 500 x 8 cm
 incl. 5 x LED GU5,3/MR16, 3 W
 5 x 260 lm, 3.000 K

770010587



↔ max. 500 x 11 cm
 incl. 5 x SMD-LED, 3,8 W
 5 x 350 lm, 3.100 K

778210506



LEON

Nickel matt, Weiß matt oder Schwarz matt · nickel mat, white mat or black mat ·
 nickel mat, blanc mat ou noir mat · nikkell mat, wit mat of mat zwart ·
 níquel mate, estera blanca o estera negra · nichel opaco, bianco opaco o nero opaco ·
 nichel mat, alb mat sau negru mat · harjattu teräs, valkoinen matto tai musta matto ·
 nikiel mat, biały mat lub czarny mat

Empfohlen:
 recommended: LED GU10, 5 W
 400 lm, 3.000 K



956-55



↔ 11 x 16 cm, √ 19 cm
 excl. 1 x GU10, max. 35 W



800700107
 800700131
 800700132



↔ 28 x 16 cm, √ 19 cm
 excl. 2 x GU10, max. 35 W



800700207
 800700231
 800700232



↔ 44 x 16 cm, √ 19 cm
 excl. 3 x GU10, max. 35 W



800700307
 800700331
 800700332



↔ 60 x 16 cm, √ 19 cm
 excl. 4 x GU10, max. 35 W



800700407
 800700431
 800700432



07 Nickel matt · nickel mat
 31 Weiß matt · white mat
 32 Schwarz matt · black mat





GOA

Metall, Weiß matt oder Schwarz matt · metal, white mat or black mat ·
 metale, blanc mat ou noir mat · metaal, wit mat of mat zwart ·
 metal, estera blanca o estera negra · metallo, bianco opaco o nero opaco ·
 metal, alb mat sau negru mat · metalli, valkoinen matto tai musta matto ·
 metal, biały mat lub czarny mat · metal, beyaz mat veya siyah mat

Empfohlen:

recommended: LED GU10, 5 W
 400 lm, 3.000 K



956-55



↓ 11 cm, ↗ 14,5
 excl. 1 x GU10, max. 10 W



800600131
 800600132



↔ 29 x 11 cm, ↓ 14,5 cm
 excl. 2 x GU10, max. 10 W



800600231
 800600232



↔ 62 x 11 cm, ↓ 14,5 cm
 excl. 4 x GU10, max. 10 W



800600431
 800600432



∅ 25 cm, ↓ 14,5 cm
 excl. 3 x GU10, max. 10 W



800690331
 800690332



31 Weiß matt · white mat
 32 Schwarz matt · black mat





MARLEY

Metall, Weiß oder Schwarz matt · metal, white or black mat ·
 metale, blanc ou noir mat · metaal, wit of mat zwart · metal, blanco o estera negra ·
 metallo, bianco o nero opaco · metal, alb sau negru mat · metalli, valkoinen tai musta matto ·
 metal, biały lub czarny mat

Empfohlen:
 recommended: LED GU10, 5 W
 400 lm, 3.000 K



956-55



↓ 12 x 12 cm, ↗ 15 cm
 excl. 1 x GU10, max. 35 W



802400101
 802400132



↔ 30 x 9 cm, ↓ 15 cm
 excl. 2 x GU10, max. 35 W



802400201
 802400232



↔ 48 x 9 cm, ↓ 15 cm
 excl. 3 x GU10, max. 35 W



802400301
 802400332



↔ 24 x 24 cm, ↓ 15 cm
 excl. 4 x GU10, max. 35 W



802430401
 802430432



↓ 150 cm, ↔ 12 x 12 cm, Ø 6 cm
 excl. 1 x GU10, max. 35 W



312400101
 312400132



595



↔ 77,5 x 57,5 cm, ↑ 22,5 cm
excl. 5 x GU10, max. 35 W



612400501
612400532



↔ 75 x 9 cm, ↑ 150 cm
excl. 4 x GU10, max. 35 W



312400401
312400432



↑ 18 x 6 cm, ↗ 8 cm
excl. 2 x GU10, max. 35 W



212400201
212400232



01 Weiß · white
32 Schwarz matt · black mat



↓ 12 x 12 cm, ↗ 15 cm
excl. 1 x GU10, max. 35 W



802400107
802400124



↓ 18 x 6 cm, ↗ 8 cm
excl. 2 x GU10, max. 35 W



212400207
212400224



↓ 150 cm, ↔ 12 x 12 cm, Ø 6 cm
excl. 1 x GU10, max. 35 W



312400107
312400124



↔ 75 x 9 cm, ↓ 150 cm
excl. 4 x GU10, max. 35 W



312400407
312400424



MARLEY

Metall, Nickel matt oder rostfarbig · metal, nickel mat or rusty ·
 metale, nickel mat ou rouille · metaal, nikkell mat of roestkleur · metal, níquel mate o óxido ·
 metallo, nichel opaco o ruggine · metal, nichel mat sau ruginiu · metalli, harjattu teräs tai rustiikki ·
 metal, nikiel mat lub miedz

Empfohlen:
 recommended: LED GU10, 5 W
 400 lm, 3.000 K



956-55



↔ 77,5 x 57,5 cm, ↓ 22,5 cm
 excl. 5 x GU10, max. 35 W



612400507
 612400524



↔ 30 x 9 cm, ↓ 15 cm
 excl. 2 x GU10, max. 35 W



802400207
 802400224



↔ 48 x 9 cm, ↓ 15 cm
 excl. 3 x GU10, max. 35 W



802400307
 802400324



↔ 24 x 24 cm, ↓ 15 cm
 excl. 4 x GU10, max. 35 W



802430407
 802430424



07 Nickel matt · nickel mat
24 rostfarbig · rusty



↔ 9 x 9 cm, ↗ 15 cm
excl. 1 x GU10, max. 35 W

↔ 24 x 7 cm, ↑ 15 cm
excl. 2 x GU10, max. 35 W

↔ 41 x 7 cm, ↑ 15 cm
excl. 3 x GU10, max. 35 W

↔ 24 x 24 cm, ↑ 15 cm
excl. 4 x GU10, max. 35 W



803500131
803500132

803500231
803500232

803500331
803500332

803590431
803590432

31 Weiß matt · white mat
32 Schwarz matt · black mat



PAGO

Metall, Weiß matt oder Schwarz matt · metal, white mat or black mat ·
metale, blanc mat ou noir mat · metaal, wit mat of mat zwart ·
metal, estera blanca o estera negra · metallo, bianco opaco o nero opaco ·
metal, alb mat sau negru mat · metalli, valkoinen matto tai musta matto ·
metal, biały mat lub czarny mat

Empfohlen:

recommended: LED GU10, 5 W
400 lm, 3.000 K



956-55

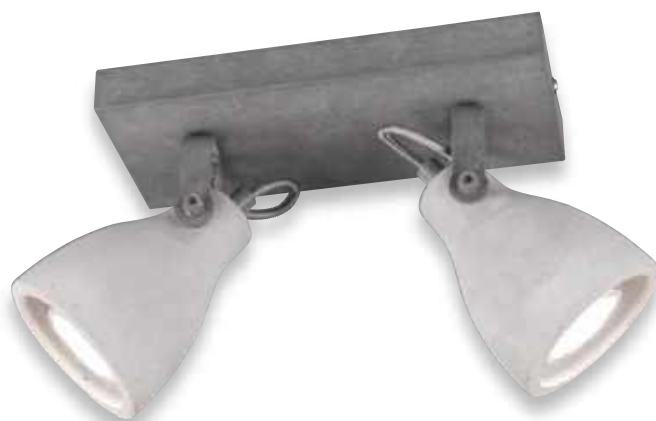

↔ 10 x 15 cm, ↗ 18 cm
excl. 1 x GU10, max. 42 W



802500178



↔ 23 x 10 cm, ↑ 18 cm
excl. 2 x GU10, max. 42 W



802500278



↔ 35 x 10 cm, ↑ 18 cm
excl. 3 x GU10, max. 42 W



802500378



CONCRETE

Beton, Grau · concrete, grey ·
 béton, gris · beton, grijs · hormigón, gris · cemento, grigio · beton, gri · betoni,
 harmaa · beton, popielaty · beton, gri

Empfohlen:
 recommended: LED GU10, 5 W
 400 lm, 3.000 K



956-55



↔ 23 x 23 cm, ↑ 18 cm
 excl. 4 x GU10, max. 42 W



802530478



↑ 160 cm, ↔ 34 cm
 excl. 3 x GU10, max. 42 W



402500378

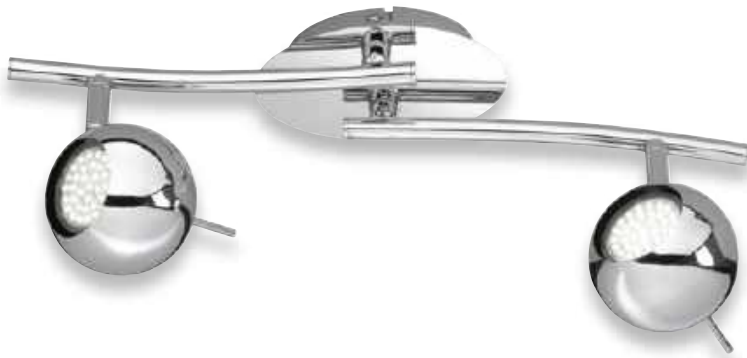

BOWIE

Chrom · chrome ·
chrome · chroom · cromo ·
cromo · crom · kromi · chrom · krom

Empfohlen:
recommended: LED GU10, 3 W
250 lm, 3.000 K



956-30



↓ 14 x 8 cm, ↗ 15 cm
excl. 1 x GU10, max. 25 W



818070106



↔ 40 x 8 cm, ↓ 18 cm
excl. 2 x GU10, max. 25 W



818000206



↔ 55 x 8 cm, ↓ 18 cm
excl. 3 x GU10, max. 25 W



818000306





↓ 10,6 x 6 cm, ↗ 13 cm
excl. 1 x GU10, max. 28 W



803000107



↓ 37 x 7 cm, ↗ 22 cm
excl. 1 x GU10, max. 28 W



803080107



↔ 32 x 5 cm, ↓ 13 cm
excl. 2 x GU10, max. 28 W



803000207



↔ 54 x 5 cm, ↓ 13 cm
excl. 3 x GU10, max. 28 W



803000307



↔ 80 x 10 cm, ↓ 20 cm
excl. 4 x GU10, max. 28 W



803000407



MICHAEL

Nickel matt · nickel mat ·
nickel mat · nikkell mat · níquel mate ·
nichel opaco · nichel mat · harjattu teräs ·
nikiel mat · mat nikel

Empfohlen:
recommended: LED GU10, 5 W
400 lm, 3.000 K



956-55



↔ 180 x 10 cm, ↓ 18 cm
excl. 6 x GU10, max. 28 W



803000607



Ø 25,5 cm, ↓ 15 cm
excl. 3 x GU10, max. 28 W



803090307



CARICO

Nickel matt, Glas Weiß gewischt · nickel mat, glass white brushed glass ·
 nickel mat, verre blanc balayé · nikkell mat, wit geborsteld glas ·
 níquel mate, blanco pulido · nichel opaco, vetro bianco spazzolato ·
 nichel mat, alb lucios · harjattu teräs, lasi harjattu valkoinen ·
 nikiel mat, szkło białe otarła



Ø 9 cm, √ 16 cm
 incl. 1 x LED G9, 3 W
 250 lm, 3.000 K



871570107



↔ 34 cm, ↑ 18 cm
 incl. 2 x LED G9, 3 W
 2 x 250 lm, 3.000 K



871510207



Ø 29,5 cm, ↑ 18 cm
 incl. 3 x LED G9, 3 W
 3 x 250 lm, 3.000 K



871590307



↔ 90 cm, ↑ 19 cm
 incl. 4 x LED G9, 3 W
 4 x 250 lm, 3.000 K



871510407



↔ 150 cm, ↑ 19 cm
 incl. 6 x LED G9, 3 W
 6 x 250 lm, 3.000 K



871510607



↔ 73 x 34,5 cm, ↓ 21,5 cm
incl. 5 x LED G9, 3 W
5 x 250 lm, 3.000 K



671510507



↔ 74,5 cm, ↓ 95 - 160 cm
incl. 4 x LED G9, 3 W
4 x 250 lm, 3.000 K



371510407



Empfohlen:
recommended: Filament-LED E27, 6 W
190 lm, 3.000 K



988-654



07



↔ 12 x 13 cm, ↗ 12,5 cm
excl. 1 x E27, max. 25 W



800570104
800570107



↔ 30 x 11,5 cm, ↓ 12,5 cm
excl. 2 x E27, max. 25 W



800570204
800570207



↔ 75 x 9 cm, ↓ 12,5 cm
excl. 4 x E27, max. 25 W



800500404
800500407



∅ 26 cm, ↓ 12,5 cm
excl. 3 x E27, max. 25 W



800590304
800590307



04 Altmessing · old brass
07 Nickel matt · nickel mat



CARL

Altmessing oder Nickel matt · old brass or nickel mat ·
laiton fumé ou nickel mat · oud brons of nikkel mat ·
bronce viejo o níquel mate · ottone invecchiato o nichel opaco ·
bronz antic sau nichel mat · antiikkimessinki tai harjattu teräs ·
patyna lub nikiel mat

Empfohlen:

recommended: Filament-LED E27, 4 W
320 lm, 2.700 K



904-479



LEVISTO

Nickel matt oder Messing matt, Glas alabasterfarbig ·
 nickel mat or brass mat, alabaster-coloured glass · nickel mat ou laiton
 mat, verre couleur albâtre · nikkell mat of messing mat, albastkleurig glas ·
 níquel mate o bronce mate, vidrio de color alabastro · nichel opaco o
 ottone satinato, vetro colore alabastro · nichel mat sau bronz mat, sticla
 culoare alabastru · harjattu teräs tai mattamessinki, lasi alabasteri väri ·
 nikiel mat lub mosiądz mat, szkło alabaster kolor

incl.
 LED E14, 5 W
 400 lm, 3.000 K



983-60



Ø 10 cm, ↗ 19 cm
 incl. 1 x LED E14, 5 W
 400 lm, 3.000 K

871010107
871010108



↔ 33 cm, ↑ 19 cm
 incl. 2 x LED E14, 5 W
 2 x 400 lm, 3.000 K

871010207
871010208



↔ 55 cm, ↑ 19 cm
 incl. 3 x LED E14, 5 W
 3 x 400 lm, 3.000 K

871010307
871010308



Ø 30 cm, ↓ 21 cm
 incl. 3 x LED E14, 5 W
 3 x 400 lm, 3.000 K

871090307
871090308



↔ 88 cm, ↑ 19 cm
 incl. 4 x LED E14, 5 W
 4 x 400 lm, 3.000 K

871010407
871010408





↔ 180 cm, ↓ 21 cm
incl. 6 x LED E14, 5 W
6 x 400 lm, 3.000 K



↔ 60,5 cm, ↓ 95 - 160 cm
incl. 3 x LED E14, 5 W
3 x 400 lm, 3.000 K



871010607
871010608

371010307
371010308



↔ 80,5 cm, ↓ 95 - 160 cm
incl. 4 x LED E14, 5 W
4 x 400 lm, 3.000 K



371010407
371010408



07 Nickel matt · nickel mat
08 Messing matt · brass mat

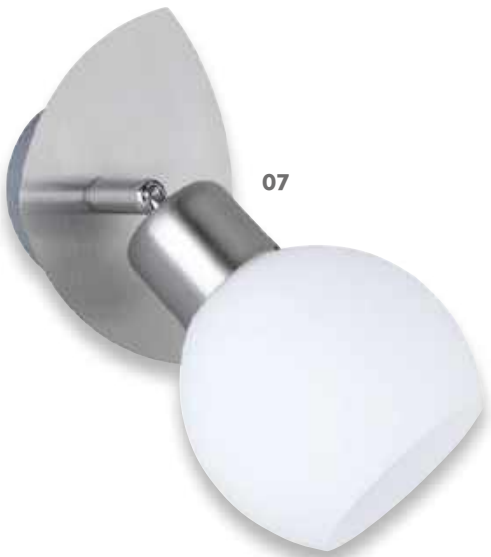

07

FREDDY

Nickel matt oder rostfarbig, Glas matt ·
 nickel mat or rusty, mat glass ·
 nickel mat ou rouille, verre mat · nikkell mat of roestkleur,
 mat glas · níquel mate o óxido, vidrio mate · nichel
 opaco o ruggine, vetro sabbiato · nichel mat sau ruginiu,
 sticla mata · harjattu teräs tai rustiikki, mattalasi ·
 nikiel mat lub miedź, szkło matowane

incl.
 LED E14, 4 W
 320 lm, 3.000 K



983-40



↓ 13 x 10 cm, ↗ 19 cm
 incl. 1 x LED E14, 4 W
 320 lm, 3.000 K

824810107
 824810128



↔ 30 cm, ↓ 20 cm
 incl. 2 x LED E14, 4 W
 2 x 320 lm, 3.000 K

824810207
 824810228



↔ 45 cm, ↓ 20,5 cm
 incl. 3 x LED E14, 4 W
 3 x 320 lm, 3.000 K

824810307
 824810328



↔ 60 cm, ↓ 20,5 cm
 incl. 4 x LED E14, 4 W
 4 x 320 lm, 3.000 K

824810407
 824810428



Ø 52 cm, ↓ 19 cm
 incl. 3 x LED E14, 4 W
 3 x 320 lm, 3.000 K

624830307
 624830328





↓ 40 cm, ↗ 28 cm
incl. 1 x LED E14, 4 W
320 lm, 3.000 K



524810107
524810128



↓ 150 cm, ↗ 55 cm
incl. 1 x LED E14, 4 W
320 lm, 3.000 K



424810107
424810128



↓ 125 cm, ↗ 55 cm
incl. 2 x LED E14, 4 W
2 x 320 lm, 3.000 K



424810207
424810228



↔ 78 cm, ↑ 85 - 180 cm
incl. 4 x LED E14, 4 W
4 x 320 lm, 3.000 K



324810407
324810428



07 Nickel matt · nickel mat
28 rostfarbig antik · antique rust



04

07

TRUMPET

Nickel matt oder Altmessing, Glas matt · nickel mat or old brass, mat glass ·
 nickel mat ou laiton fumé, verre mat · nikkell mat of oud brons, mat glas ·
 níquel mate o bronce viejo, vidrio mate · nichel opaco o ottone invecchiato, vetro sabbiato ·
 nichel mat sau bronz antic, sticla mata · harjattu teräs tai antiikkimessinki, mattalasi ·
 nikiel mat lub patyna, szkło matowane

Empfohlen:
 recommended: LED E14, 5 W
 400 lm, 3.000 K



983-60



∅ 9 cm, ↗ 17 cm
 excl. 1 x E14, max. 40 W



803100104
 803100107



↔ 26 cm, ↑ 19,5 cm
 excl. 2 x E14, max. 40 W



803100204
 803100207



↔ 41 cm, ↑ 19,5 cm
 excl. 3 x E14, max. 40 W



803100304
 803100307



↔ 68 cm, ↑ 19,5 cm
 excl. 4 x E14, max. 40 W



803100404
 803100407



04 Altmessing · old brass
 07 Nickel matt · nickel mat



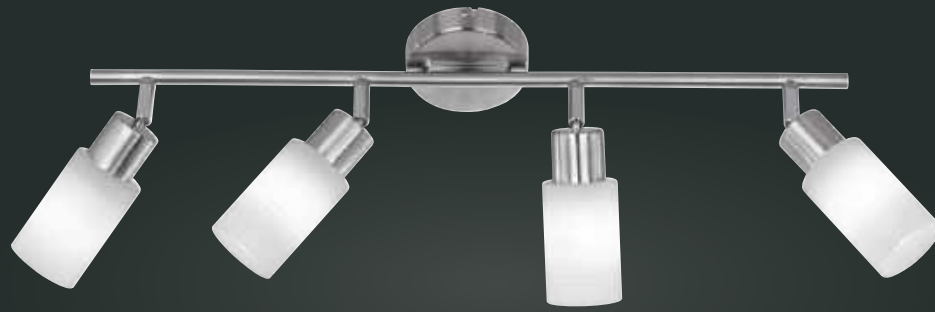

JONES

Nickel matt, Glas Weiß gewischt · nickel mat, glass white brushed glass ·
nickel mat, verre blanc balayé · nikkel mat, wit geborsteld glas ·
níquel mate, blanco pulido · nichel opaco, vetro bianco spazzolato ·
nichel mat, alb lucios · harjattu teräs, lasi harjattu valkoinen ·
nikiel mat, szkło białe otarła

incl.
LED E14, 4 W
320 lm, 3.000 K



989-40



Ø 8 cm, ↗ 18 cm
incl. 1 x LED E14, 4 W
320 lm, 3.000 K

871410107



↔ 30 cm, ↑ 18 cm
incl. 2 x LED E14, 4 W
2 x 320 lm, 3.000 K

871410207



↔ 44 cm, ↑ 18 cm
incl. 3 x LED E14, 4 W
3 x 320 lm, 3.000 K

871410307



↔ 60 cm, ↑ 18 cm
incl. 4 x LED E14, 4 W
4 x 320 lm, 3.000 K

871410407



HOUSTON

Metall, Schwarz/goldfarbig · metal, black/gold ·
 metale, noir/ro · metaal, zwart/goud · metal, negro/oro ·
 metallo, nero/oro · metal, negru/aur · metalli, musta/kultaa ·
 metal, czarny/złota

Empfohlen:
 recommended: Filament LED E14, 4 W
 470 lm, 3.000 K



989-400



↔ 9,5 x 12 cm, ↗ 17 cm
 excl. 1 x E14, max. 40 W



800300132



↔ 36,5 cm, ↓ 19 cm
 excl. 2 x E14, max. 40 W



800300232



↔ 69,5 cm, ↓ 19 cm
 excl. 4 x E14, max. 40 W



800300432



A modern office interior featuring a glass-walled conference room on the left. The ceiling is white and equipped with numerous recessed spotlights. The floor is a light-colored, textured material. In the background, a large window offers a view of a city skyline.

Einbauleuchten

Recessed spots

Spots encastrés

Inbouwspots

Focos empotrables

Faretti incasso

Spoturi incastrate

Upotetut spotit

Oprawy wbudowane



3er Set/3 pc.



↔ 8,5 x 8,5 cm, ↓ 5,4 cm
incl. 3 x SMD, 5,5 W
3 x 345 lm, 3.000 K

∅ 8,5 cm, ↓ 5,4 cm
incl. 3 x SMD, 5,5 W
3 x 345 lm, 3.000 K



650410306
650410307
650410331

650510306
650510307
650510331

06 Chrom · chrome
07 Nickel matt · nickel mat
31 Weiß matt · white mat

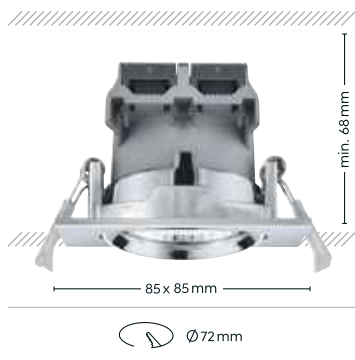

PAMIR

Metall · metal ·
metale · metaal · metal · metallo ·
metal · metalli · metal ·



621



↔ 8,5 x 8,5 cm, ↑ 5,4 cm
incl. 1 x SMD, 5,5 W
345 lm, 3.000 K



650410106
650410107
650410131
650410132



Ø 8,5 cm, ↑ 5,4 cm
incl. 1 x SMD, 5,5 W
345 lm, 3.000 K



650510106
650510107
650510131
650510132



06 Chrom · chrome
07 Nickel matt · nickel mat
31 Weiß matt · white mat
32 Schwarz matt · black mat



07



06

3er Set/3 pc.

622



↔ 8,5 x 8,5 cm, ↓ 5,4 cm
incl. 3 x SMD, 5,5 W
3 x 345 lm, 3.000 K



650610306
650610307
650610331

∅ 8,5 cm, ↓ 5,4 cm
incl. 3 x SMD, 5,5 W
3 x 345 lm, 3.000 K



650710306
650710307
650710331



06 Chrom · chrome
07 Nickel matt · nickel mat
31 Weiß matt · white mat

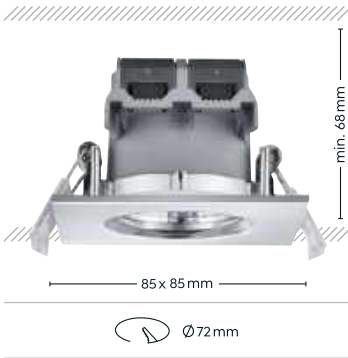

ZAGROS

Metall · metal ·
metale · metaal · metal · metallo ·
metal · metalli · metal



32

623



↔ 8,5 x 8,5 cm, ↑ 5,4 cm
incl. 1 x SMD, 5,5 W
345 lm, 3.000 K



650610106
650610107
650610131
650610132

∅ 8,5 cm, ↑ 5,4 cm
incl. 1 x SMD, 5,5 W
345 lm, 3.000 K



650710106
650710107
650710131
650710132



06 Chrom · chrome
07 Nickel matt · nickel mat
31 Weiß matt · white mat
32 Schwarz matt · black mat



07



31

3er Set/3 pc.



↔ 8 x 8 cm, ↑ 3,4 cm
incl. 3 x SMD, 5 W
3 x 370 lm, 3.000 K



650210306
650210307
650210331

∅ 8,2 cm, ↑ 3,4 cm
incl. 3 x SMD, 5 W
3 x 370 lm, 3.000 K



650310306
650310307
650310331



06 Chrom · chrome
07 Nickel matt · nickel mat
31 Weiß matt · white mat



RILA

Metall · metal ·
metale · metaal · metal · metallo ·
metal · metalli · metal

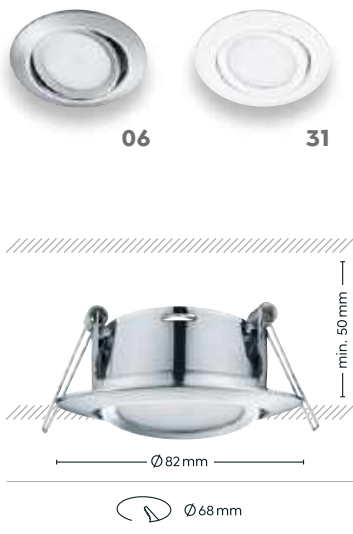

↔ 8 x 8 cm, ↑ 3,4 cm
incl. 1 x SMD, 5 W
370 lm, 3.000 K



650210106
650210107
650210131



Ø 8,2 cm, ↑ 3,4 cm
incl. 1 x SMD, 5 W
370 lm, 3.000 K



650310106
650310107
650310131



06 Chrom · chrome
07 Nickel matt · nickel mat
31 Weiß matt · white mat





PINDOS

Metall · metal ·
metale · metaal · metal · metallo ·
metal · metalli · metal



Ø 22,5 cm, ↑ 2,8 cm
incl. SMD-LED, 18 W
1.500 lm, 3.000 K



650910106
650910107
650910131



06 Chrom · chrome
07 Nickel matt · nickel mat
31 Weiß matt · white mat



1x

2x

3x



Getrennt schaltbar · Separately switchable
Interrupteurs séparés · Gescheiden schakelbaar ·
Interruptores separados · Interruttori separati ·
Intrerruptoare separate · Erikseen kytkettävissä ·
Oddzieleny przełącznik



AURA

Kunststoff, Weiß oder Chrom · plastic, white or chrome ·
 plastique, blanc ou chrome · kunststof, wit of chroom ·
 plástico, blanco o cromo · plastica, bianco o cromo ·
 plastic, alb sau crom · muovi, valkoinen tai kromi ·
 plastik, biały lub chrom



31



06



Ø 8,2 cm, ↓ 4 cm
 incl. 1 x SMD, 5 W
 450 lm, 3.000 K



652310106
 652310131



Ø 14,5 cm, ↓ 3,7 cm
 incl. 1 x SMD, 10 W
 1.040 lm, 3.000 K



652410106
 652410131



06 Chrom · chrome
 31 Weiß matt · white mat

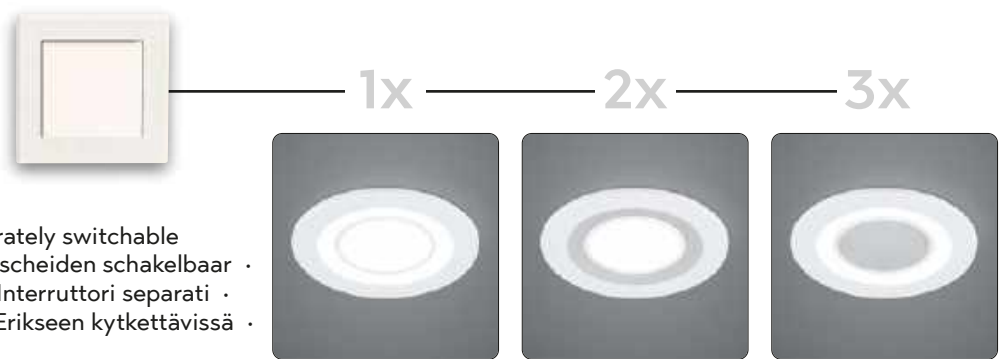

Getrennt schaltbar · Separately switchable
Interrupteurs séparés · Gescheiden schakelbaar ·
Interruptores separados · Interruttori separati ·
Intrerupatoare separate · Erikseen kytkettävissä ·
Oddzielny przełącznik



CORE

Kunststoff, Weiß oder Chrom · plastic, white or chrome ·
 plastique, blanc ou chrome · kunststof, wit of chrom ·
 plástico, blanco o cromo · plastica, bianco o cromo ·
 plastic, alb sau crom · muovi, valkoinen tai kromi ·
 plastik, biały lub chrom



31



06

631



Ø 8,2 cm, ↑ 3,5 cm
 incl. 1 x SMD, 5 W
 450 lm, 3.000 K



652510106
 652510131



Ø 14,5 cm, ↑ 3,2 cm
 incl. 1 x SMD, 10 W
 1.040 lm, 3.000 K



652610106
 652610131



06 Chrom · chrome
 31 Weiß matt · white mat



DOLOMITE

Kristallglas · crystal glass ·
 verre cristal · kristal glas · vidrio cristal ·
 vetro cristallo · sticla cristal · kristallilasi ·
 szkło kryształ



Ø 9 cm, ↓ 9,5 cm
 excl. 1 x GU10, max. 10 W



651700152

↔ 10 x 10 cm, ↓ 9,5 cm
 excl. 1 x GU10, max. 10 W



651800152

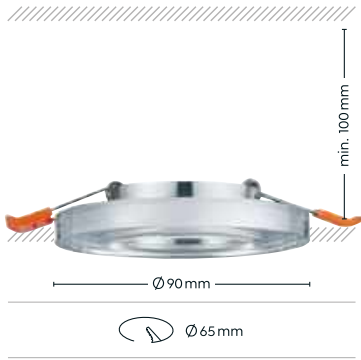

PIRIN

Kristallglas · crystal glass ·
 verre cristal · kristal glas · vidrio cristal ·
 vetro cristallo · sticla cristal · kristallilasi ·
 szkło kryształ

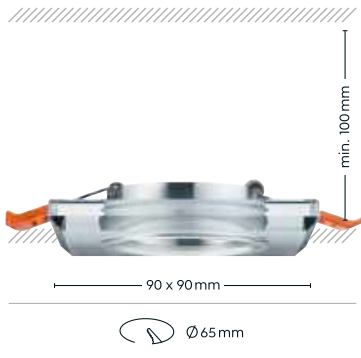

Empfohlen:

recommended: LED GU10, 3 W
 250 lm, 3.000 K, $\approx 110^\circ$



956-30

LED GU10, 5 W
 400 lm, 3.000 K, $\approx 36^\circ$



956-5736

LED GU10, 5 W
 400 lm, 3.000 K, $\approx 36^\circ$



956-5936



$\varnothing 9$ cm, $\updownarrow 7$ cm
 excl. 1 x GU10, max. 10 W



652100152



$\leftrightarrow 9 \times 9$ cm, $\updownarrow 7$ cm
 excl. 1 x GU10, max. 10 W



652200152



31

32

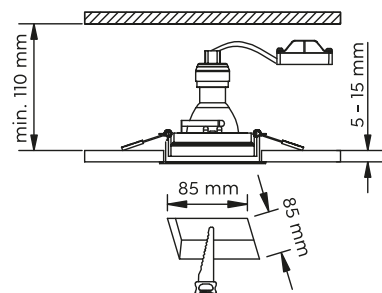
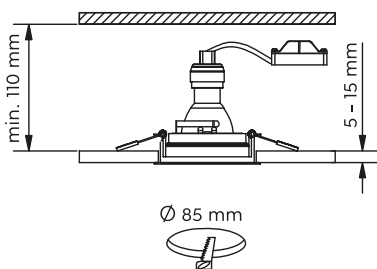

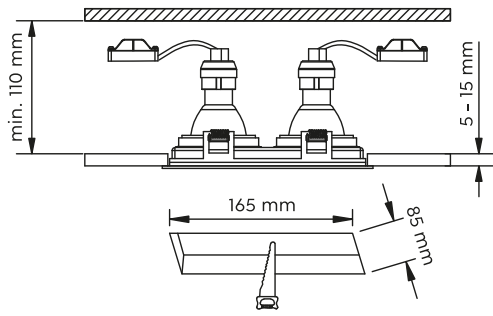

Empfohlen:

recommended: LED GU10, 3 W
250 lm, 3.000 K, $\approx 110^\circ$



956-30

LED GU10, 5 W
400 lm, 3.000 K, $\approx 36^\circ$



956-5736

LED GU10, 5 W
400 lm, 3.000 K, $\approx 36^\circ$



956-5936

KENAI

Metall · metal ·
metale · metaal · metal · metallo ·
metal · metalli · metal

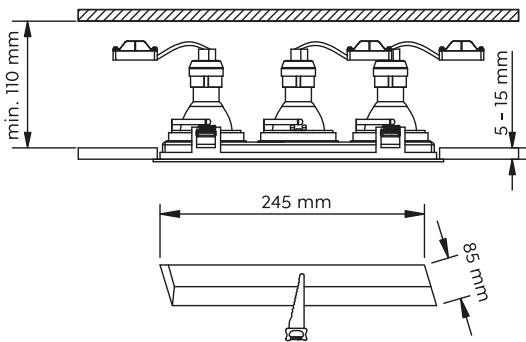

635



Ø 9,2 cm, ↓ 10 cm
excl. 1 x GU10, max. 15 W



651500131
651500132



↔ 9,2 x 9,2 cm, ↓ 10 cm
excl. 1 x GU10, max. 15 W



651600131
651600132



↔ 17,2 x 9,2 cm, ↓ 10 cm
excl. 2 x GU10, max. 15 W



651600231
651600232



↔ 25,2 x 89,2 cm, ↓ 10 cm
excl. 3 x GU10, max. 15 W



651600331
651600332



31 Weiß matt · white mat
32 Schwarz matt · black mat



31



07

3er Set/3 pc.



↔ 8 x 8 cm, ↓ 7 cm
excl. 3 x GU10, max. 15 W

∅ 8,3 cm, ↓ 7 cm
excl. 3 x GU10, max. 15 W



650000306
650000307
650000331

650100306
650100307
650100331

06 Chrom · chrome
07 Nickel matt · nickel mat
31 Weiß matt · white mat

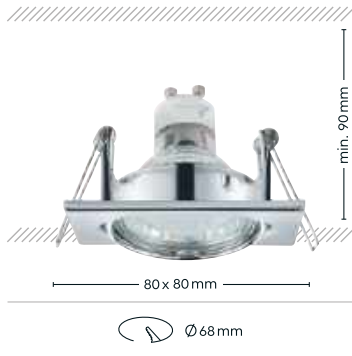

JURA

Metall · metal ·
metale · metaal · metal · metallo ·
metal · metalli · metal

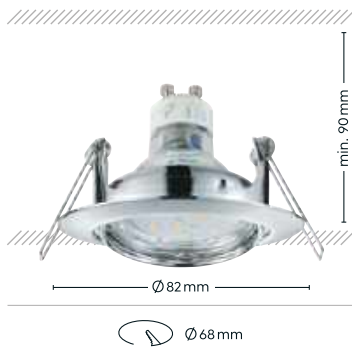

08

Empfohlen:
recommended: LED GU10, 3 W
250 lm, 3.000 K, $\approx 110^\circ$



956-30

LED GU10, 5 W
400 lm, 3.000 K, $\approx 36^\circ$



956-5736

LED GU10, 5 W
400 lm, 3.000 K, $\approx 36^\circ$



956-5936



\leftrightarrow 8 x 8 cm, \updownarrow 7 cm
excl. 1 x GU10, max. 15 W



650000106
650000107
650000108
650000131
650000132



\varnothing 8,3 cm, \updownarrow 7 cm
excl. 1 x GU10, max. 15 W



650100106
650100107
650100108
650100131
650100132



06 Chrom · chrome
07 Nickel matt · nickel mat
08 Messing matt · brass mat
31 Weiß matt · white mat
32 Schwarz matt · black mat





Badezimmerleuchten

Bathroom lighting

Éclairage salle de bains

Badkamer verlichting

Iluminación de cuarto de baño

Illuminazione per bagno

Iluminat baie

Kylpyhuone valaistus

Oświetlenie łazienkowe



BRIAN

Chrom, Acryl · chrome, acryl ·
 chrome, acryl · chroom, acryl · cromo, acrílico ·
 cromo, acrílico · crom, acrílic · kromi, akryyli ·
 chrom, akryl

IP44



↑ 10 cm, ↔ 8,5 cm, ↗ 12,5 cm
 incl. 1 x SMD-LED, 3,6 W
 260 lm, 3.000 K

↑ 16,5 cm, ↔ 8,5 cm, ↗ 12,5 cm
 incl. 2 x SMD-LED, 2,8 W
 2 x 180 lm, 3.000 K

IP44

IP44



282710106

282710206





BOLSA

Chrom, Acryl · chrome, acryl ·
 chrome, acryl · chroom, acryl · cromo, acrílico ·
 cromo, acrilico · crom, acrylic · kromi, akryyli ·
 chrom, akryl



↑ 19 cm, ↔ 7 cm, ↗ 12 cm
 incl. 1 x SMD-LED, 3,1 W
 310 lm, 3.000 K

IP44

282410106



↑ 30 cm, ↔ 7 cm, ↗ 12 cm
 incl. 2 x SMD-LED, 3,2 W
 2 x 300 lm, 3.000 K

IP44

282410206



Ø 41,5 cm, ↑ 16,5 cm
 incl. 5 x SMD-LED, 3,1 W
 5 x 310 lm, 3.000 K

IP44

682410506



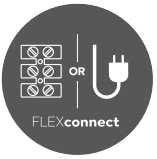

Seite/page 685

VIEW

Chrom · chrome ·
chrome · chroom · cromo · cromo ·
crom · kromi · chrom



Ø 22 cm, √ max. 36 cm
incl. SMD-LED, 3 W
280 lm, 3.000 K



282990106



↓ 20 x 20 cm, √ max. 36 cm
incl. SMD-LED, 3 W
280 lm, 3.000 K



283090106



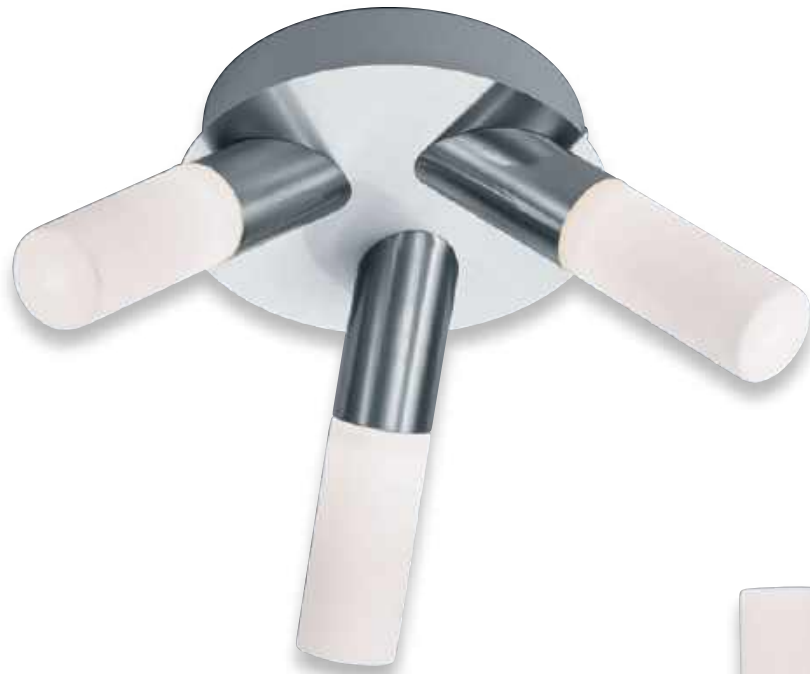

07



06



DYLAN

Chrom oder Nickel matt, Glas matt · chrome or nickel mat, mat glass ·
 chrome ou nickel mat, verre mat · chroom of nikkell mat, mat glas ·
 cromo o níquel mate, vidro mate · cromo o nichel opaco, vetro sabbato ·
 crom sau nichel mat, sticla mata · kromi tai harjattu teräs, mattalasi ·
 chrom lub nikiel mat, szkło matowane



↓ 20 x 11 cm, ↗ 12,5 cm
 incl. 1 x SMD, 4,3 W
 430 lm, 3.000 K



283370106
 283370107



↓ 34,5 x 13 cm, ↗ 9 cm
 incl. 2 x SMD, 4,3 W
 2 x 430 lm, 3.000 K



283370206
 283370207



Ø 37 cm, ↓ 18,5 cm
 incl. 3 x SMD, 4,3 W
 3 x 430 lm, 3.000 K



683310306
 683310307



06 Chrom · chrome
 07 Nickel matt · nickel mat



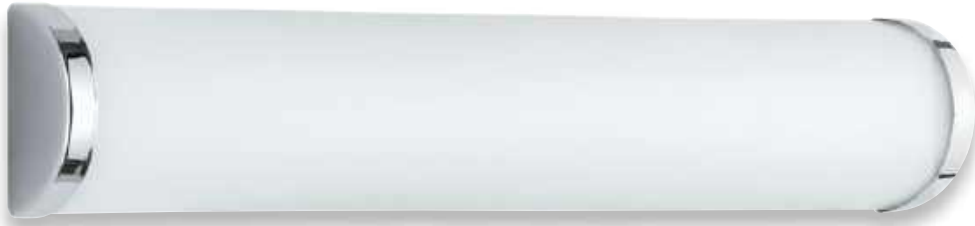

XAVI

Chrom, Glas matt · chrome, mat glass ·
chrome, verre mat · chroom, mat glas · cromo, vidrio mate ·
cromo, vetro sabbato · crom, sticla mata · kromi, mattalasi ·
chrom, szkło matowane

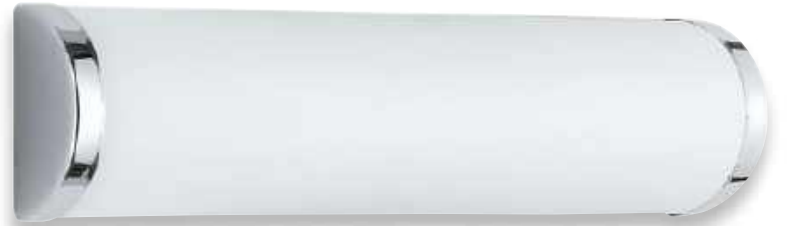

RAY

Chrom, Acryl · chrome, acryl ·
chrome, acryl · chroom, acryl · cromo, acrílico · cromo, acrilico ·
crom, acrilic · kromi, akryyli · chrom, akryl

IP44



↔ 30,4 cm, ↓ 8 cm, ↗ 6 cm
excl. 2 x E14, max. 28 W



2803021-06



↔ 40,5 cm, ↓ 8 cm, ↗ 6 cm
excl. 3 x E14, max. 28 W



2803031-06



↓ 8,3 x 5,2 cm, ↗ 8 cm
incl. 1 x SMD-LED, 4 W
340 lm, 3.000 K



283110106



↓ 16,6 x 5,2 cm, ↗ 8 cm
incl. 2 x SMD-LED, 4 W
2 x 340 lm, 3.000 K



283110206



H₂O



NILO

Chrom, Acryl · chrome, acryl ·
chrome, acryl · chroom, acryl · cromo, acrílico ·
cromo, acrilico · crom, acrylic · kromi, akryyli ·
chrom, akrýl



KOLIAN

Chrom, Acryl · chrome, acryl ·
chrome, acryl · chroom, acryl · cromo, acrílico ·
cromo, acrilico · crom, acrylic · kromi, akryyli ·
chrom, akrýl



650



↔ 88 x 7,5 cm, ↗ 2,5 cm
incl. SMD-LED, 9 W
900 lm, 3.000 K

↔ 120 x 7 cm, ↗ 2,5 cm
incl. SMD-LED, 12 W
1.200 lm, 3.000 K

↔ 44 x 6 cm, ↗ 9 cm
incl. SMD-LED, 6 W
600 lm, 3.000 K

↔ 64 x 6 cm, ↗ 9 cm
incl. SMD-LED, 9 W
970 lm, 3.000 K



281770906



281771206



281570606



281570906





MATTIMO

Chrom, Acryl · chrome, acryl ·
 chrome, acryl · chroom, acryl · cromo, acrílico ·
 cromo, acrílico · crom, acrilic · kromi, akryyli ·
 chrom, akryl

IP44



↔ 40 x 5,5 cm, √ 8,5 cm
 incl. 1 x SMD-LED, 4,3 W
 450 lm, 3.000 K



283270106



↔ 60 x 5,5 cm, √ 8,5 cm
 incl. 1 x SMD-LED, 6,5 W
 680 lm, 3.000 K



283270206



↔ 80 x 5,5 cm, √ 8,5 cm
 incl. 1 x SMD-LED, 8,6 W
 880 lm, 3.000 K



283270306





87



01

CLARIMO

Acryl, Weiß oder titanfarbig · acryl, white or titan ·
 acryl, blanc ou titane · acryl, wit of titaan · acrílico, blanco o titán ·
 acrilico, bianco o titano · acrilic, alb sau titaniu · akryyli, valkoinen tai titaani ·
 akryl, biały lub tytanowy

IP44



Ø 33 cm, ↑ 9 cm,
 incl. SMD-LED, 18 W
 1.600 lm, 3.000 K

IP44



659011801
 659011887

01 Weiß · white
 87 titanfarbig · titanium-coloured



APART

Acryl, Chrom · acryl, chrome ·
acryl, chrome · acryl, chrom · acrílico, cromo ·
acrilico, cromo · acrylic, crom · akryyli, kromi ·
akryl, chrom

IP44



Ø 35 cm, ↑ 9,5 cm,
incl. SMD-LED, 18 W
1.600 lm, 3.000 K



659411806



Ø 41 cm, ↑ 10 cm,
incl. SMD-LED, 24 W
2.100 lm, 3.000 K



659412406



01



06



07

CONDUS

Metall, Glas matt · metal, mat glass ·
 metale, verre mat · metaal, mat glas · metal, vidrio mate ·
 metallo, vetro sabbato · metal, sticla mata · metalli, mattalasi ·
 metal, szkło matowane

IP44



Ø 31,5 cm, ↑ 8 cm
 excl. 1 x E27, max. 42 W



6801011-01
 6801011-06
 6801011-07



01 Weiß · white
 06 Chrom · chrome
 07 Nickel matt · nickel mat

COMPO

Metall Weiß · metal white ·
metale blanc · metaal wit · metal blanco ·
metallo bianco · metal alb · metalli valkoinen · metal biały

IP65

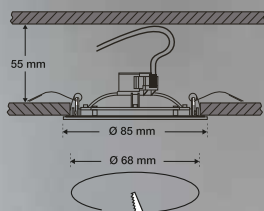

Ø 8,5 cm
incl. 1 x SMD-LED, 4,3 W
345 lm, 3.000 K

IP65

629510101





Leuchtmittel

Light sources

Ampoules

Lichtbronnen

Fuentes de luz

Lampadine

Becuri

Valonlähteet

Źródła światła

LED-Leuchtmittel

LED bulbs · Ampoules LED · LED-lampen · Bombillas a LED ·
Lampadine a LED · Becuri cu LED-uri · LED-Valonlähdeet · Żarówka LED



↓ 110 mm, ↔ 60 mm
LED E27, 10 W
806 lm, 3.000 K
25.000 h



988-10



↓ 98 mm, ↔ 37 mm
LED E14, 6 W
470 lm, 3.000 K
25.000 h



989-66



↓ 80 mm, ↔ 45 mm
LED E14, 6 W
470 lm, 3.000 K
25.000 h



983-66



↓ 52 mm, ↔ 50 mm
LED GU10, 5 W
400 lm, 3.000 K, ⚡ 110°
25.000 h



956-55



↓ 52 mm, ↔ 50 mm
LED GU10, 5 W
400 lm, 3.000 K, ⚡ 36°
20.000 h



956-5736



↓ 55 mm, ↔ 18 mm
LED G9, 3 W
300 lm, 3.000 K
25.000 h



929-230 Blister: 2 St./2 pc.

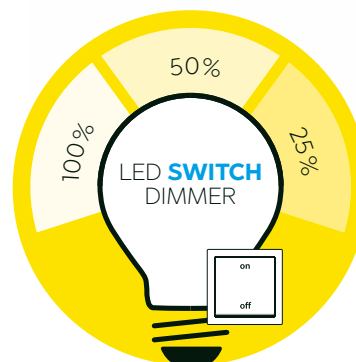

DIMMEN OHNE DIMMER

Dimming without dimmer · Ajuster le niveau
d'éclairage sans variateur · Dimmen zonder dimmer ·
Regulable sin regulador · Dimmerabile senza Dimmer ·
Ajustarea nivelului de lumina fara variator de lumina ·
Himentäminen ilman himmennintä

LED-Filament-Leuchtmittel

LED-filament bulbs · Lampes LED-filament · LED-gloeilampen · Lámparas de filamento de LED · Lampade a filamento LED · Lămpi cu LED-filament · LED-hehkulamput · Lampy LED-żarowe



↑ 106 mm, ↔ 60 mm
Filament LED E27, 8 W
806 lm, 2.700 K
10.000 h



987-6810



↑ 105 mm, ↔ 60 mm
Filament LED E27, 8 W
700 lm, 2.700 K
10.000 h



987-6700



↑ 143 mm, ↔ 95 mm
Filament LED E27, 8 W
806 lm, 2.700 K
10.000 h



985-6810



↑ 173 mm, ↔ 125 mm
Filament LED E27, 8 W
810 lm, 2.700 K
10.000 h



986-6810



↑ 80 mm, ↔ 45 mm
Filament LED E14, 4 W
470 lm, 2.700 K
10.000 h



983-4470



↑ 99 mm, ↔ 35 mm
Filament LED E14, 4 W
470 lm, 2.700 K
10.000 h



989-4470



↑ 99 mm, ↔ 35 mm
Filament LED E14, 4 W
470 lm, 2.700 K
10.000 h



990-4470



↑ 160 x 80 cm, ↗ 40 cm

PP005

LED-Leuchtmittel

LED bulbs · Ampoules LED · LED-lampen · Bombillas a LED ·
Lampadine a LED · Becuri cu LED-uri · LED-Valonlähdeet · Żarówki LED



↑ 106 mm, ↔ 60 mm
LED E27, 6 W
470 lm, 3.000 K
25.000 h

987-60



↑ 110 mm, ↔ 60 mm
LED E27, 7 W
560 lm, 3.000 K
25.000 h



dimmable

988-700



↑ 110 mm, ↔ 60 mm
LED E27, 10 W
800 lm, 3.000 K
25.000 h



dimmable

988-110



↑ 75 mm, ↔ 45 mm
LED E27, 4 W
320 lm, 3.000 K
25.000 h

986-40

986-43 Blister: 3 St./3 pc.



↑ 78 mm, ↔ 45 mm
LED E27, 5 W
400 lm, 3.000 K
25.000 h

986-60

986-63 Blister: 3 St./3 pc.



↑ 99 mm, ↔ 37 mm
LED E14, 4 W
320 lm, 3.000 K
25.000 h

989-40

989-43 Blister: 3 St./3 pc.



↑ 102 mm, ↔ 37 mm
LED E14, 5 W
400 lm, 3.000 K
25.000 h



dimmable

989-56



↑ 99 mm, ↔ 37 mm
LED E14, 6 W
470 lm, 3.000 K
25.000 h

989-60

989-63 Blister: 3 St./3 pc.



↑ 130 mm, ↔ 37 mm
LED E14, 4 W
320 lm, 3.000 K
25.000 h

990-40



↑ 80 mm, ↔ 45 mm
LED E14, 4 W
320 lm, 3.000 K
25.000 h

983-40

983-43 Blister: 3 St./3 pc.



↑ 80 mm, ↔ 45 mm
LED E14, 5 W
400 lm, 3.000 K
25.000 h



dimmable

983-56



↑ 80 mm, ↔ 45 mm
LED E14, 5 W
400 lm, 3.000 K
25.000 h

983-60

983-63 Blister: 3 St./3 pc.



↓ 80 mm, ↔ 50 mm
LED E14, 5 W
400 lm, 3.000 K, ⚡ 120°
25.000 h

955-55



↓ 57 mm, ↔ 50 mm
LED GU10, 3 W
250 lm, 3.000 K, ⚡ 110°
25.000 h

956-30



↓ 52 mm, ↔ 50 mm
LED GU10, 5 W
400 lm, 3.000 K, ⚡ 36°
20.000 h



dimmable

956-5936



↓ 60 mm, ↔ 50 mm
LED GU10, 5 W
400 lm, 3.000 K, ⚡ 120°
25.000 h

955-50



↓ 50 mm, ↔ 20 mm
LED G9, 3 W
300 lm, 3.000 K
25.000 h



dimmable

929-2300 Blister: 2 St./2 pc.



↓ 48 mm, ↔ 16 mm
LED G9, 2,5 W
210 lm, 3.000 K
25.000 h

929-220 Blister: 2 St./2 pc.

LED-Filament-Leuchtmittel

LED-filament bulbs · Lampes LED-filament · LED-gloeilampen · Lámparas de filamento de LED · Lampade a filamento LED · Lămpi cu LED-filament · LED-hehkulamput · Lampy LED-żarowe



↑ 105 mm, ↔ 60 mm
Filament LED E27, 4 W
470 lm, 3.000 K
10.000 h

987-400

987-2400 Blister: 2 St./2 pc.



↑ 99 mm, ↔ 35 mm
Filament LED E14, 4 W
470 lm, 3.000 K
10.000 h

989-400



↑ 99 mm, ↔ 35 mm
Filament LED E14, 4 W
400 lm, 2.700 K
10.000 h

989-479



↑ 120 mm, ↔ 35 mm
Filament LED E14, 4 W
470 lm, 3.000 K
10.000 h

990-400



↑ 78 mm, ↔ 45 mm
Filament LED E14, 4 W
470 lm, 3.000 K
10.000 h

983-400



↑ 140 mm, ↔ 64 mm
Filament LED E27, 6 W
600 lm, 3.000 K
10.000 h

987-600



↑ 140 mm, ↔ 64 mm
Filament LED E27, 6 W
420 lm, 2.700 K
10.000 h

987-679



↑ 136 mm, ↔ 95 mm
Filament LED E27, 6 W
600 lm, 3.000 K
10.000 h

988-600



↑ 108 mm, ↔ 60 mm
Filament LED E27, 4 W
420 lm, 2.800 K
25.000 h

987-410



↑ 78 mm, ↔ 45 mm
Filament LED E14, 4 W
420 lm, 2.800 K
25.000 h

983-410



↑ 140 mm, ↔ 95 mm
Filament LED E27, 7 W
680 lm, 2.700 K
25.000 h



dimmable

988-710



↑ 180 mm, ↔ 125 mm
Filament LED E27, 7 W
680 lm, 2.700 K
25.000 h



dimmable

986-710



↓ 168 mm, ↔ 115 mm
Filament LED E27, 4 W
320 lm, 2.700 K
25.000 h

901-479



↓ 142 mm, ↔ 110 mm
Filament LED E27, 4 W
320 lm, 2.700 K
25.000 h

902-479



↓ 138 mm, ↔ 80 mm
Filament LED E27, 4 W
320 lm, 2.700 K
25.000 h

903-479



↓ 168 mm, ↔ 115 mm
Filament LED E27, 4 W
140 lm, 3.000 K
25.000 h

901-454



↓ 138 mm, ↔ 115 mm
Filament LED E27, 4 W
140 lm, 3.000 K
25.000 h

902-454



↓ 138 mm, ↔ 80 mm
Filament LED E27, 4 W
140 lm, 3.000 K
25.000 h

903-454



↓ 136 mm, ↔ 95 mm
Filament LED E27, 6 W
420 lm, 2.700 K
25.000 h

988-679



↓ 135 mm, ↔ 95 mm
Filament LED E27, 4 W
320 lm, 2.700 K
25.000 h

904-479



↓ 135 mm, ↔ 95 mm
Filament LED E27, 4 W
140 lm, 3.000 K
25.000 h

904-454



↓ 138 mm, ↔ 95 mm
Filament LED E27, 6 W
190 lm, 3.000 K
25.000 h

988-654



↓ 300 mm, ↔ 30 mm
Filament LED E27, 4 W
320 lm, 2.700 K
25.000 h

905-479



↓ 300 mm, ↔ 30 mm
Filament LED E27, 4 W
100 lm, 3.000 K
25.000 h

905-454

LED-Leuchtmittel

LED bulbs · Ampoules LED · LED-lampen · Bombillas a LED ·
Lampadine a LED · Becuri cu LED-uri · LED-Valonl hteet ·  ar wki LED

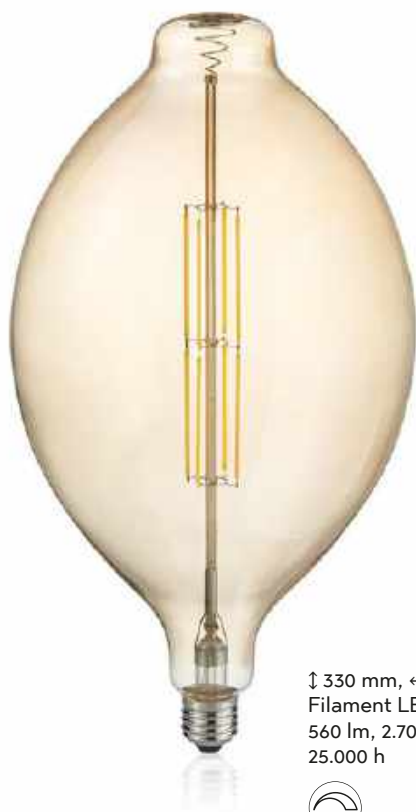

↑ 330 mm, ↔ 180 mm
Filament LED E27, 8 W
560 lm, 2.700 K
25.000 h



dimmable 908-879



↑ 320 mm, ↔ 180 mm
Filament LED E27, 8 W
560 lm, 2.700 K
25.000 h



dimmable 906-879



↑ 265 mm, ↔ 200 mm
Filament LED E27, 8 W
560 lm, 2.700 K
25.000 h



dimmable 907-879



↑ 340 mm, ↔ 175 mm
Filament LED E27, 8 W
260 lm, 2.700 K
25.000 h



dimmable 908-854



↑ 305 mm, ↔ 180 mm
Filament LED E27, 8 W
260 lm, 2.700 K
25.000 h



dimmable 906-854



↑ 265 mm, ↔ 200 mm
Filament LED E27, 8 W
260 lm, 2.700 K
25.000 h



dimmable 907-854

Displays

Présentoirs · Espositores · Espositori ·
Display-uri · Telineet · Wyświetla · Teşhir

Topper
PT 0013



667

n, 40 cm

RK78-901

Displays

Présentoirs · Espositores · Espositori ·
Display-uri · Telineet · Wyświetla · Teşhir



RK53 Topper PT 0011 DE



RK52 Topper PT 0012 DE

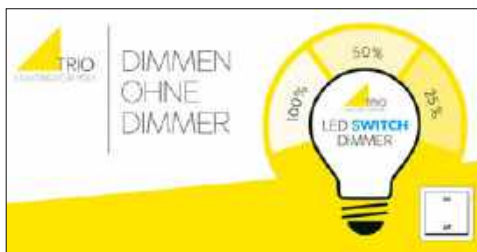

RK51 Topper PT 0013 DE



Displays

Présentoirs · Espositores · Espositori ·
Display-uri · Telineet · Wyświetla · Teşhir



Sticker
POST 1033

Sticker
POST 1034



↔ 120 x 80 cm, ↓ 210 cm

RK63

Displays

Présentoirs · Espositores · Espositori ·
Display-uri · Telineet · Wyświetla · Teşhir



↔ 240 x 140 cm, ↓ 241 cm

RK65



↔ 400 cm, ↓ 260 cm

DUOline



POST 1031

↑ 160 x 50 cm, ↔ 50 cm

RK75-6275

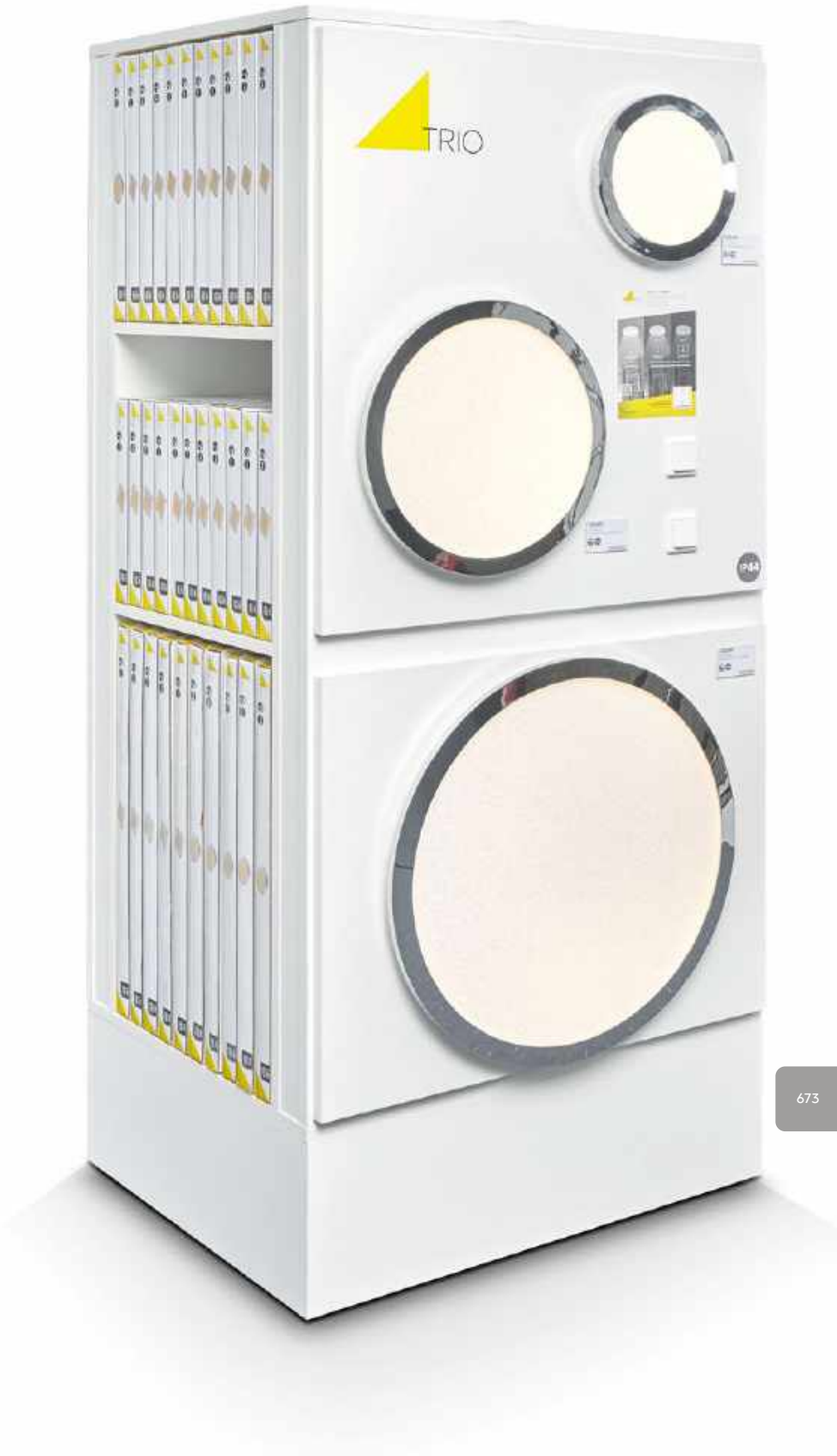

673

↔ 80 x 63 cm, ↓ 184 cm

RK58

Spezifikationen

Specifications

Spécifications

Specificaties

Especificaciones

Specifiche

Specificații

Tekniset tiedot

Specyfikacje

Produkteigenschaften

Features · Caractéristiques · Kenmerken · Acabados · Caratteristiche · Caracteristici · Ominaisuudet · Cechy



Schalter · Switch

Interrupteur · Schakelaar · Interruptor · Interruttore · Intrerupator · Kytkin · Przełącznik



Fußschalter · Footswitch

interrupteur à pédale · Voetschakelaar · Interruptor de pie · interruttore a pedale · comutator picior · Päälle / pois jalkakytin · wyłącznik nożny



Schnurschalter · Cable switch

Interrupteur de cordon · Snoerschakelaar · Cable de interruptor · Interruttore su cavo · Intrerupator cu cablu · katkaisin ja johto · Przełącznik na kablu



On/Off Touch Funktion · On/Off Touch function

Interrupteur tactile On/Off · Touch schakelaar On/Off · Función táctil On/Off · Interruttore touch On/Off · Intrerupator tactil On/Off · Kosketuskäyttöinen On/Off · Funkcja dotykowa On/Off



Getrennt schaltbar · Separately switchable

Interrupteurs séparés · Gescheiden schakelbaar · Interruptores separados · Interruttori separati · Intrerupatoare separate · Erikseen kytkettävissä · Oddzileny przełącznik



Fernbedienung · Remote control

Commande à distance · Afstandsbediening · Mando a distancia · Comando a distanza · Telecomanda · Kauko-ohjain · Pilot



Integrierter Dimmer · Integrated dimmer

Variateur intégré · Geïntegreerde dimmer · Regulador integrado · Dimmer integrato · Variator de lumina integrat · Integroitu himmennin · Wbudowany ściemniacz



Zugschalter · Pull switch

Interrupteur de trait · Trekschakelaar · Interruptor de tiro · Interruttore con tirata · Interupator de tragere · Vetokytin · Przełącznik pociągany



Sensordimmer · Sensor dimmer

Variateur tactile · Touchdimmer · Regulador con sensor · Touchdimmer · Variator cu senzor · Kosketushimmennin · Czujnik ściemniania



Extern dimmbar · Externally dimmable

Dimmable avec variateur externe · Extern dimbaar · Dimmable por regulador externo · Dimmerabile con dimmer esterno · variator extern de lumina · himmennettävissä · Zewnętrznie ściemniania



RGB Farbwechsler · RGB Colorchanging

Changement de couleur RGB · RGB Kleurverandering · Cambio de color RGB · Cambia colore RGB · Schimbator de culoare RGB · Värinvaihto RGB · Zmieniający kolor RGB



Lichtfarbe einstellbar · Adjustable light color

Couleur de lumière réglable · Lichtkleur instelbaar · Color de luz regulable · Colore della luce regolabile · Lumina colorata reglabila · Värilämpötila säädettävissä · Regulowana barwa światła



Made in Europe · Made in Europe

Made in Europe · Made in Europe · Made in Europe · Made in Europe · Made in Europe · Made in Europe



Höhenverstellbar · Adjustable height

Hauteur réglable · In hoogte verstelbaar · Altura regulable · Altezza regolabile · Inaltime reglabila · Säädettävä korkeus · Regulowana wysokość



Schwenkbar · Tilttable

Pivotant · Draaibaar · Pivotante · Girevole · Pivotant · Suunnattava · Skråtøy



Steckdose · Plug

Prise · Stekker · Enchufe · Spina · Priza · Katkaisin · Gniazdko



Vergößerung 3x · Magnification 3x

Magnification 3x · Vergroting 3x · Aumentos 3x · Ingrandimento 3x · Suplimentare 3x · Suurentava 3x · Powiększenie 3x



4 fach TOUCH · 4 level Touch function

Interrupteur tactile 4 niveaux · Touch schakelaar 4 niveaus · Función Táctil 4 nivel · Interruttore touch 4 livelli · Intrerupator tactil 4 nivele · Kosketuskäyttöinen 4 taso · Funkcja dotykowa 4 poziomy



Flexibel · Flexible

Flexible · Flexibel · Flexible · Flessibile · Flexibil · Joustava · Elastyczne



Lichtfarbe stufenlos einstellbar · Light color infinitely variable

Couleur de lumière infiniment variable · Lichtkleur traploos instelbaar · Color de luz infinitamente variable · Colore della luce infinitamente variabile · Culoare lumină infinit variabilă · Valon väri portaattomasti · Jasny kolor bezstopniowo



USB Anschluss · USB connection
Entrée USB · USB aansluiting · Conexión USB ·
Connessione USB · Conexiune USB · USB-liitäntä ·
Połączenie USB



USB Anschluss mit Ladefunktion · Recharging USB
connection
Entrée USB de rechargement · Opladende USB
aansluiting · Conexión USB de recarga · Connessione
USB di ricarica · Conexiune USB reîncărcare ·
Lataaminen USB-liitäntä · ładowania USB połączenie



Nachtlicht · Night light
Veilleuse de nuit · Nachtlicht · Luz de la noche ·
Luce notturna · Lampă de noapte · Yyövalo ·
Lampka nocna



Gestensteuerung · Gesture control
Contrôle gestuel · Gebarenbediening · Control gestual ·
Controllo gestuale · Control prin gesturi/mișcarea mâinii ·
Kädellä ohjattava liiketunnistin · Sterowana gestami



Up and down Beleuchtung · Up and Down lighting
Point lumineux en haut et en bas · Lichtpunt boven en
onder · Luz de arriba y abajo · Luce su e giù · Sus și în
jos lumina · Ylös ja alas valoa · W górę iw dół światło



Dimmbar mit Schalter · Dimmable via switch
Réglable avec interrupteur · Dimbaar via schakelaar ·
Regulable mediante interruptor · Dimmerabile tramite
interruttore · Estompat prin comutator · Himmennettävä
kytkimen · Ściemnialne za pośrednictwem przełącznika



Stufenlos dimmbar mit Schalter · Infinitely dimmable
with switch
Infiniment réglable avec interrupteur · Traploos dimbaar met
schakelaar · Infinitamente regulable con interruptor ·
Infinitamente dimmerabile con interruttore · Reglabil infinit
cu un intrerupator · Porttaattomasti himmennettävä kytki-
mellä · Bezstopniowo ściemnialna z przełącznikiem



Weckfunktion · Wake up function
Fonction réveil · Wekfunctie · Despierte ·
Sveglia · Trezeste-te funcția · Herätys toiminto ·
Obudź się funkcji



Induktive Ladestation · Inductive loading station
Station de chargement inductif · Inductief laadstation ·
Estación de carga inductiva · Stazione di carico
induttivo · Stație de încărcare inductivă · Induktiivinen
latausasema · Stacja ładowania indukcyjnego



Musterschutz · Registered model
Modèle déposé · Beschermd model ·
Modelo certificado · Modello depositato ·
Înregistrați model · Rekisteröity malli ·
Zarejestrowany wzór



Starlight Effekt · Starlight effect
Effet étoiles · Starlight effekt · Efecto estrella ·
Effetto stelle · Efect de "stele" · Tähti efekti ·
Efekt starlight



RGBW Farbwechsler · RGBW Colorchanging
Changement de couleur RGBW · RGBW Kleurverandering ·
Cambio de color RGBW · Cambia colore RGBW ·
Schimbator de culoare RGBW · Värvinvaihto RGB ·
Zmieniający kolor RGBW



Ohne Leuchtmittel · Lamp(s) excluded
Sans ampoule(s) · Zonder lichtbron(nen) ·
Sin bombilla(s) · Lampadina Esclusa · Fara bec (s) ·
Ilman polttimo (s) · Bez żarówki (s)



Lichtfarbe mit Schalter einstellbar · Light color
adjustable with switch
Couleur de lumière réglable avec interrupteur · Lichtkleur
instelbaar met schakelaar · Color de la luz ajustable con
interruptor · Colore della luce regolabile con interruttore ·
Culoarea luminii reglabila cu un comutator · Valon väri
säädettävällä kytkimellä · Kolor światła regulowane z
przełącznikiem



Ausziehbar · Extendible
extensible · Verlengbaar · Extensible ·
Estensibile · extensibila · Jatkettava ·
Rozsuwalny



Memory Funktion · Memory function
fonction mémoire · Geheugen functie ·
Función de memoria · Funzione memorizzazione ·
functia memorie · Muistitoiminto · Funkcja pamięci



indirekte Beleuchtung · indirect lighting
lumière indirecte · indirecte belichting ·
Iluminación indirecta · Illuminazione a scomparsa ·
iluminat indirect · epäsuora valaistus ·
oświetlenie pośrednie



SwitchDimtoWarm · Switch Dim-to-Warm
SwitchDimtoWarm · SwitchDimtoWarm ·
SwitchDimtoWarm · SwitchDimtoWarm ·
SwitchDimtoWarm · SwitchDimtoWarm ·
SwitchDimtoWarm

Farben & Materialien

Colours and materials · Couleurs et matériaux · Kleuren en materialen · Colores y materiales ·
Colori e materiali · Culori si materiale · Värit ja materiaalit · Kolory i materiały · Renkler ve malzemeler

- 00** Transparent · transparent
transparent · transparant · transparente · transparente ·
transparent · kirkas · przezroczysty · şeffaf
- 01** Weiß · white
blanc · wit · blanco · bianco · alb · valkoinen · biały · beyaz
- 02** Schwarz · black
noir · zwart · negro · nero · negru · musta · czarny · siyah
- 03** Messing poliert · polished brass
laiton polis · gepolijst messing · bronze · ottone lucido ·
bronz · messinki · mosiądz polerowany · piring
- 04** Altmessing · old brass
laiton fumé · oud brons · bronze viejo · ottone invecchiato ·
bronz antic · antiikkimessinki · patyna · antik piring
- 05** Aluminium gebürstet · brushed aluminium
aluminium balayé · geborsteld aluminium · aluminio pulido ·
alluminio spazzolato · aluminiu lucios · harjattu alumiini ·
aluminium szczotkowane · alüminyum
- 06** Chrom · chrome
chrome · chroom · cromo · cromo · crom ·
kromi · chrom · krom
- 07** Nickel matt · nickel mat
nickel mat · nikkelt mat · níquel mate · nichel opaco ·
nichel mat · harjattu teräs · nikiel mat · mat nikel
- 08** Messing matt · brass mat
laiton mat · messing mat · bronze mate · ottone satinato ·
bronz mat · mattamessinki · mosiądz mat · mat piring
- 09** Kupferfarbig · copper
cuivré · koperkleurig · color cobre · colore rame · cupru ·
kuperinvärinen · kolorze miedzi · bakir renkli
- 10** Rot · red
rouge · rood · rojo · rosso · rosu ·
punainen · czerwony · kırmızı
- 11** Grau · grey
gris · grijs · gris · grigio · gri · harmaa · popielaty · gri
- 12** Blau · blue
bleu · blauw · azul · azzurro · gri · sininen · niebieski · mavi
- 13** Amber · amber
ambre · amber · ámbar · ambra · amber · meripihka ·
bursztynowy · amber
- 14** Braun · brown
brun · bruin · marron · marrone · maro · ruskea ·
brązowy · kahverengi
- 15** Grün · green
vert · groen · verde · verde · verde · vihreä · zielony · yeşil
- 16** Gelb · yellow
jaune · geel · amarillo · giallo · galben ·
keltainen · żółty · sarı
- 17** mehrfarbig · multicolor
multicolore · multicolor · multicolor · multicolore ·
multicolor · monivärinen · multi-kolor · çok renkli
- 18** Orange · orange
orange · oranje · naranja · arancione · portocaliu ·
oranssi · pomarańczowy · turuncu
- 19** Türkis · turquoise
turquoise · turquoise · turquesa · turchese · turcoaz ·
turkoosi · turkusowy · turkuvaz
- 24** rostfarbig · rusty
rouille · roestkleur · óxido · ruggine · ruginiu · rustiikki ·
miedź · pas
- 26** Braun · brown
brun · bruin · marron · marrone · maro · ruskea ·
brązowy · kahverengi
- 27** Weiß antik · antique white
blanc antique · antiek wit · blanco decapé · bianco anticato ·
alb antic · antiikkivalkoinen · antyczny biały · antik beyaz
- 28** rostfarbig antik · antique rust
rouille antique · roestkleur antiek · oxido · ruggine anticato ·
ruginiu antic · rustiikki · antyczny rdzawy · antik pas rengi
- 29** Kupfer matt · copper mat
cuivre mat · koper mat · estera de cobre · rame opaco ·
cupru mat · kupari mat · miedź mat · bakır mat
- 30** holzfarbig · wood coloured
couleur bois · houtkleur · color madera · colore di legno ·
culoare lemn · puunvärinen · kolor drewna · ahşap renk
- 31** Weiß matt · white mat
blanc mat · wit mat · estera blanca · bianco opaco · alb mat ·
valkoinen matto · biały mat · beyaz mat
- 32** Schwarz matt · black mat
noir mat · mat zwart · estera negra · nero opaco ·
negru mat · musta matto · czarny mat · siyah mat
- 41** Taupe · taupe
taupe · taupe · gris pardo · taupe · taupe ·
ruskeanharmaa · ciemnoszary · taupe
- 42** Anthrazit · anthracite
antracite · antraciet · antracita · antracite · antracit ·
antrasiitti · antracyt · antrasit
- 45** Pastellblau · pastel blue ·
bleu pastel · pastel blauw · azul pastel · azzurro pastello ·
albastru pastel · pastellinsininen · pastelowy niebieski ·
pastel mavi
- 51** Apfelgrün · applegreen
vert pomme · appelgroen · verde manzana · verde mela ·
verde mar · omenanvihreä · zielone jabłko · elma yeşili
- 52** Transparent klar · transparent clear
transparente claire · transparant helder · transparente claro ·
transparente chiaro · transparent clar · kirkas ·
przezroczysty · şeffaf

- 54** rauchfarbig · smoke
fumé · rookkleur · humo · fume' · fumuriu ·
savu · przydymiony · duman
- 61** Grau antik · antique grey
gris ancien · antiek grijs · gris antiguo · grigio antico ·
antic gri · antiikki harmaa · starodawny szary · antika gri
- 62** Kupfer antik · antique copper
cuivre ancien · antiek koper · cobre antiguo · rame antico ·
cupru antic · antiikki kupari · antyczne miedzi · antik bakır
- 64** Bronze · bronze
bronze · bronze · bronco · bronzo · bronz ·
pronssi · brąz · tunç
- 67** Nickel antik · nickel antique
nickel antique · antiek nikkell · níquel antiguo · nickel anticato ·
nichel antic · antiikkiteräs · aikiel antyczny · antik nikel
- 78** betonfarbig · concrete look
couleur beton · beton kleur · color concreto ·
calcestruzzo · culoare beton · konkreettisia väri ·
konkretny kolor · beton rengi
- 79** goldfarbig · gold
or · goud · oro · oro · aur · kultaa · złota · altın
- 87** titanfarbig · titan
titane · titaan · titán · titano · titaniu ·
titaani · tytanowy · titan
- 88** Silber antik · antique silver
argent antique · antiek zilver · plateado antiquo ·
argento anticato · argint antic · antiikkihopea ·
antyczne srebro · gümüş antika
- 89** silberfarbig · silver
argent · zilver · plata · argento · argint ·
hopea · srebrny · gümüş
- 91** Lila · lilac
lilla · lilla · lila · lilla · lila · lila · liliowy · leylak
- 92** Purpurrot · purple
pourpre · paars · púrpura · porpora · purpuriu ·
purppura · purpurowy · mor
- 93** Pink · pink
rose · pink · rosa · rosa · roz · pinkki · różowy · pembe
- 94** Pastellrosa · pastel pink ·
rose pastel · pastel rose · rosa pastel · rosa pastello ·
roz pastel · pastellin pinkki · pastelowy róż · pastel pembe

Get your light connected.

FR NL ES IT RO FI PL

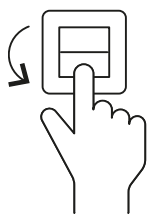

WiZ CLICK

Simple et efficace. Deux modes d'éclairage préférés peuvent être commandés via l'interrupteur d'éclairage existant.

Eenvoudig en effectief. Twee voorkeurstellingen kunnen worden bediend via de bestaande lichtsckakelaar.

Helppoa ja tehokasta. Kaksi toivottua valo asetusta jota voidaan käyttää seinäkytkimellä.

Simplu si efectiv. Pot fi operate 2 moduri de iluminat preferate prin comutatorul de lumina existent.

Semplice ed efficace. È possibile utilizzare due modalità di illuminazione preferite tramite l'interruttore della luce esistente.

Simple y efectivo. Dos ambientes de luz preferidos pueden operar a través del interruptor convencional.

Proste i efektywne. Dwa preferowane tryby oświetlenia można obsługiwać za pomocą dostępnego przełącznika oświetlenia.

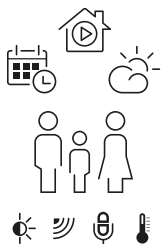

WiZ MAGIC

Contrôle des lumières par programme horraire, par capteurs ou par simples commandes vocales. Compatible avec Amazon Alexa et Google Home.

Aansturing van de lampen met tijdschema's, door sensoren of via eenvoudige spraakopdrachten. Compatibel met Amazon Alexa en Google Home.

Valoja voi säätää aikataulutetusti, sensoreilla tai yksinkertaisilla ääni komennoilla. Yhteensopiva Amazon Alexan ja Google Homen kanssa.

Controlul luminilor prin programarea orei/timpului, cu senzori sau printr-o simpla comanda verbala. Compatibil cu Amazon Alexa si Google Home.

Controllo delle luci secondo gli orari, con sensori o semplici comandi verbali. Compatibile con Amazon Alexa e Google Home.

Control de las luces con horarios, con sensores o por simples comandos de voz. Compatible con Alexa de Amazon y Google Home.

Ustawianie i sterowanie lampami za pomocą harmonogramów.



WiZ APP

Installation facile et rapide. Toutes les fonctionnalités et flexibilité disponible avec l'application WiZ, téléchargeable sur App Store ou Google Play.

Eenvoudig en snel te installeren. Volledige functionaliteit en flexibilititeit met de WiZ-app - beschikbaar in de App Store of op Google Play.

Helppo ja nopea asentaa. Käyttö WiZ-aplikaatiolla - saatavissa App Storesta tai Google Play kaupasta.

Instalare usoara si rapida. Functionalitate completa si flexibilitate cu WIZ App -disponibil pe App store sau pe Google Play.

Facile e veloce da installare. Piena funzionalità e flessibilità con l'App WiZ disponibile su App Store e su Google Play.

Fácil y rápido de instalar. Amplia funcionalidad y flexibilidad con la aplicación WiZ, disponible en la App Store o en Google Play.

Prosta i szybka instalacja. Pełna funkcjonalność i elastyczność dzięki aplikacji WiZ – dostępnej w App Store lub Google Play.



WiZ MOTE

Contrôle via la télécommande et possibilité de sauvegarder quatre modes d'éclairage favoris.

Aansturen via de afstandsbediening en mogelijkheid om vier favoriete licht instellingen te bewaren.

Toimintojen säätö kaukosäätimellä ja mahdollisuus tallentaa neljä valo asetusta.

Controlul prin telecomanda si posibilitatea de a memora/salva 4 moduri favorite.

Controllo tramite telecomando e possibilità di salvare quattro modalità luce preferite.

Control vía mando a distancia y con posibilidad de guardar 4 ambientes favoritos.

Możliwość sterowania za pomocą pilota i zapisywania czterech preferowanych trybów oświetlenia.



Résidences multiples

Contrôlez et commandez plusieurs résidences simultanément et de n'importe où. Que ce soit votre propre maison ou votre deuxième résidence.

Meerdere locaties

Controleren en aansturen van meerdere locaties tegelijkertijd en van overal. Uw thuis of uw vakantiehuis.

Useita sijainteja

Voit hallita useita sijainteja, kotiasi tai kesäasuntoasi samanaikaisesti.

Locatii Multiple

Control si comanda a locatiilor multiple simultan si de oriunde. Fie ca te afli acasa sau in casa de vacanta

Molteplici Location

Controlla e comanda più sedi contemporaneamente e da qualsiasi luogo. Che tu sia casa tua o la tua casa vacanza.

Múltiples localizaciones

Control y cambio en múltiples localizaciones simultáneamente, tanto tu casa como en tu segunda residencia.

Kilka lokalizacji

Kontrola i sterowanie z kilku lokalizacji jednocześnie i zewsząd. Czy to z własnego domu, czy też z wakacyjnego mieszkania.

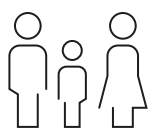

Multiplés utilisateurs

Le nombre de personnes pour contrôler les lumières peut être déterminé individuellement.

Meerdere gebruikers

Het aantal personen dat de lampen aanstuurt, kan individueel worden ingesteld.

Monta eri käyttäjää

WiZ käyttäjien määrä voidaan yksilöllisesti määrittää.

Utilizatori multipli

Numarul de persoane care sa controleze luminile poate fi setat individual.

Molteplici Utenti

Il numero di persone per controllare le luci può essere impostato individualmente.

Múltiples usuarios

El número de personas que controlan las luces se puede configurar individualmente.

Kilku użytkowników

Liczba użytkowników mogących sterować lampami może być określana indywidualnie.



Basé sur le cloud

WiZ se connecte au cloud pour stocker les préférences, partager les désirs et générer automatiquement des mises à jour.

Cloud gebaseerd

WiZ maakt verbinding met de cloud om voorkeuren op te slaan, wensen te delen en automatische updates te genereren.

Pilvipalveluun perustuva

WiZ ottaa yhteyden pilvipalveluun, tallentaa asetukset ja luo päivitykset automaattisesti.

Pe baza de Cloud

WiZ te conectează la Cloud la magazinul preferat, transmite dorințele și generează update-uri în mod automat.

Basato sul Cloud

WiZ si connette al cloud per memorizzare le preferenze, condividere desideri e generare automaticamente gli aggiornamenti.

Basado en la nube

WiZ conecta con la nube para guardar tus preferencias, comparte y genera actualizaciones automáticamente.

Oparte na chmurze

WiZ łączy się z chmurą, aby zapisywać preferencje, rozdzielać życzenia i automatycznie generować aktualizacje.



Lieux multiples

Toutes les lumières peuvent être assignées à différentes pièces et contrôlées avec précision - individuellement ou en groupe.

Meerder woonruimtes

Alle lampen kunnen worden toegewezen aan verschillende woonruimtes en nauwkeurig worden aangestuurd - individueel of in groepen.

Useita huoneita

Jokainen valo voidaan määrittää eri huoneelle. Hallittavissa ryhmissä tai yksittäin.

Câteva camere

Toate luminile pot fi atribuite mai multor camere diferite si pot fi controlate cu precizie -individual sai in grupuri

Numerose stanze

Tutte le luci possono essere assegnate a stanze diverse e controllate con precisione - individualmente o in gruppi.

Varias habitaciones

Todas las luces pueden ser asignadas a diferentes habitaciones y controladas con precisión - individualmente o en grupo.

Kilka pomieszczeń

Wszystkie lampy mogą być przyporządkowywane do różnych pomieszczeń i precyzyjnie sterowane – pojedynczo lub w grupach.



Pas besoin de pont

Il n'y a pas besoin d'un dispositif supplémentaire pour contrôler les lumières.

Geen hub nodig

Er is geen extra apparaat nodig om de lampen aan te sturen.

Ei tarvetta erilliselle keskukselle

Ei tarvetta erilliselle keskukselle valojen säätämiseen.

Nu e nevoie de nici un punct central

Nu e nevoie de o punte sau hub pentru a controla luminile

Non sono necessari altri hub

Non è necessario un ponte o un hub aggiuntivo per controllare le luci

No necesaria una unidad central

No es necesario una conexión adicional o unidad central para controlar las luces

Bez konieczności stosowania dodatkowych mostków

Do sterowania lampami nie jest potrzebny żaden dodatkowy mostek.



Technologie WiFi

WiZ utilise la technologie WiFi comme une solution sans fil sécurisée, indépendante, abordable et facile à installer.

WiFi-technologie

WiZ gebruikt Wi-Fi-technologie als een veilige, onafhankelijke, betaalbare en eenvoudig te installeren draadloze oplossing.

WiFi teknologia

WiZ käyttää Wi-Fi teknologiaa turvallisena, itsenäisenä, edullisena ja helppo käyttöisenä langattomana ratkaisuna.

Technologie WiFi

WiZ folosește tehnologia Wi-Fi ca o soluție de internet sigură, independentă, permisivă și ușor de instalat.

Tecnologia Wi-Fi

WiZ utilizza la tecnologia Wi-Fi come soluzione wireless sicura, indipendente, economica e facile da installare.

Tecnología WiFi

WiZ utiliza la tecnología Wi-Fi como una solución inalámbrica segura, independiente, asequible y fácil de instalar.

Tecnologia WLAN

WiZ używa technologii „WLAN” jako bezpiecznego, niezależnego, niskonakładowego i łatwego w instalacji rozwiązania radiowego.

DUOline

Système de voie à deux phases (230 V) · 2-fase-spoorsysteem (230 V) · Sistema de rieles en 2 fases (230 V) · Sistema a binario bifase (230 V) · Sistem de piste cu 2 faze (230 V) · 2-vaihekiskojärjestelmä (230 V) · 2-fazowy system prowadnic (230 V)

FR NL ES IT RO FI PL

Les avantages de DUOline en un coup d'œil :

- Conception individuelle de l'éclairage
- Une seule connexion électrique requise
- Pas besoin de transformateur
- Les luminaires peuvent être librement combinés et facilement déplacés
- Deux scénarios lumineux différents
- Commutation et variateur de lumière séparés
- Convient pour le montage au plafond et au mur

Lors de la planification, veuillez prêter une attention particulière à la position du conducteur de protection, qui doit être connecté en permanence dans le système.

I vantaggi di DUOline in sintesi:

- Progettazione individuale dell'illuminazione
- È necessario un solo collegamento di alimentazione
- Non è necessario alcun trasformatore
- Le lampade possono essere liberamente combinate e facilmente spostate
- Due differenti scenari di illuminazione
- Commutazione e dimmerazione separate
- Adatto per il montaggio a soffitto e a parete

In fase di progettazione, prestare attenzione alla posizione del conduttore di protezione, che deve essere collegato in modo continuo all'interno dell'impianto.

Zalety DUOline w skrócie:

- Indywidualny projekt oświetlenia
- Wymagane jest tylko jedno połączenie zasilania
- Nie wymaga transformatora
- Oprawy można dowolnie łączyć i łatwo przemieszczać
- Dwa różne scenariusze oświetlenia

1 Rail

La longueur maximale de l'installation est de 30 mètres par alimentation, avec une puissance totale maximale de 600 watts par phase.

Spoor

De maximale montageleugte bedraagt 30 meter per voeding, bij een een totaal vermogen van max. 600 watt per fase.

Riel

La longitud máxima de montaje es de 30 metros por alimentación, con una potencia total de 600 vatios como máximo por fase.

Binario

La lunghezza massima di installazione è di 30 metri per ogni alimentazione, con una potenza totale di max. 600 watt per fase.

Pistă

Lungimea maximă de montaj este de 30 de metri pe fiecare sursă de alimentare, la o putere totală de max. 600 W pe fază.

Kisko

Asennuksen enimmäispituus on 30 metriä syöttöä kohti, kokonaisteho enintään 600 W/vaihe.

Szyna

Maksymalna długość montażu wynosi 30 metrów na linię zasilania z łączną mocą 600 watów na jedną fazę.

2 Alimentation électrique intermédiaire/finale

L'alimentation du milieu/extrémité est montée directement au-dessus de la prise de courant et permet de connecter des rails d'un côté ou des deux côtés.

Midden-/eindevoeding

De midden-/eindevoeding wordt direct over de stroomuitgang aangebracht en maakt het mogelijk sporen op één of beide kanten aan te sluiten.

Alimentación medios/extremos

La alimentación de medios/extremos se adapta directamente mediante la toma de corriente, y permite que las lámparas se conecten por un lado o por los dos.

Alimentazione centrale/finale

L'alimentazione centrale/finale è montata direttamente sopra la presa di corrente e

Overzicht van de voordelen van DUOline:

- Individuele lichtvormgeving
- Slechts één stroomaansluiting nodig
- Geen transformator nodig
- Lampen willekeurig combineerbaar en gemakkelijk verplaatsbaar
- Twee verschillende lichtscenario's
- Apart schakelen en dimmen
- Geschikt voor plafond- en muurmontage

Let bij de planning absoluut op de positie van de beschermende geleider die binnen het systeem ononderbroken verbonden moet zijn.

Avantajele DUOline dintr-o privire:

- Structurarea individualizată a luminii
- Este necesară o singură conexiune electrică
- Nu este necesar un transformator
- Lămpile pot fi combinate liber și pot fi deplasate cu ușurință
- Două scenarii de iluminat diferite
- Comutare și reglare a intensității separate
- Adecvat pentru montajul pe plafon și pe perete

La planificare, luați neapărat în considerare poziția conductorului de protecție, care trebuie să fie conectat continuu în interiorul sistemului.

- Oddzielne włączanie i ściemnianie
- Nadaje się do montażu sufitowego i ściennego

Podczas projektowania należy zwrócić uwagę na położenie przewodu ochronnego, który musi być podłączony w całym systemie.

Las ventajas de DUOline en resumen:

- Diseño lumínico individual
- Solo un cable de corriente necesario
- Ningún transformador necesario
- Lámpara combinables libremente y fácilmente desplazable
- Dos escenarios lumínicos diferentes
- Activación y atenuación separadas
- Adecuado para su montaje en techo y pared

Al planificar, por favor, tenga en cuenta la posición de la toma de tierra, que debe estar conectado a lo largo de todo el sistema.

DUOlinen edut lyhyesti:

- Yksilöllinen valaistussuunnittelu
- Vaaditaan vain yksi sähköliitäntä
- Muuntajaa ei tarvita
- Valaisimia voidaan yhdistellä vapaasti ja siirtää helposti
- Kaksi erilaista valaistusskenaariota
- Erillinen kytkentä ja himmennys
- Sopii katto- ja seinäasennukseen

Huomioi suunnittelussa koko järjestelmään kytkettävän suojaadoituksen sijainti.

consente di collegare le guide su un lato o su entrambi i lati.

Alimentare centrală/finală

Alimentare centrală/finală este realizată direct prin intermediul conexiunii electrice și permite conectarea pistolor pe o parte sau pe ambele părți.

Keski-/päätsyöttö

Keski-/päätsyöttö asennetaan suoraan pistorasian yläpuolelle, ja se mahdollistaa kiskojen kytkemisen toiselle tai molemmille puolille.

Zasilanie pośrednie / końcowe

Zasilanie środkowe / końcowe jest instalowane bezpośrednio nad gniazdem zasilania i umożliwia podłączenie szyn z jednej lub z obu stron.

3 Alimentation intermédiaire/finale avec changeur de phase électronique

Grâce à un changeur de phase électronique, les deux phases peuvent être commutées et atténuées séparément, même avec des lignes électriques à trois conducteurs.

Midden-/eindevoeding met elektronische fasewisselaar

Door middel van een elektronische fasewisselaar kunnen de twee fasen ook bij driedradige stroomleidingen apart geschakeld en gedimd worden.

Alimentación medios/extremos con cambiador de fase electrónico

Por medio de los cambiadores de fase electrónicos, las dos fases pueden activarse y atenuarse también mediante cables de corriente de tres filamentos.

Alimentazione centrale/finale con variatore di fase elettrico

Mediante un variatore di fase elettrico, le due fasi possono essere commutate e dimmerate separatamente, anche con linee di alimentazione a tre conduttori.

Alimentare centrală/finală cu schimbător electronic de fază

Prin intermediul dispozitivului electronic de schimbare a fazelor se pot comuta și regla două faze chiar și în cazul cablurilor electrice cu trei fire.

Keski-/päätsyöttö elektronisella vaihtimella

Sähköistä vaihdinta käyttämällä nämä kaksi vaihtetta voidaan kytkeä ja himmentää erikseen jopa kolmijohtimisella kaapeloinnilla.

Zasilanie pośrednie / końcowe z elektronicznym przełącznikiem faz

Za pomocą elektronicznych zmieniaaczy faz obie fazy można przełączać i przyciemniać osobno, nawet w przypadku trójprzewodowych linii zasilania.

4 Alimentation électrique flexible

L'alimentation électrique flexible est nécessaire si les rails ne peuvent pas être posés directement sur la prise de courant.

Flexibele stroomtoevoer

Flexibele stroomtoevoer is nodig, als de sporen niet direct over de stroomuitgang gelegd kunnen worden.

Suministro de corriente flexible

El suministro de corriente flexible será necesario si las lámparas no pueden desplegarse directamente sobre la toma de corriente.

Sistema di alimentazione flessibile

Il sistema di alimentazione flessibile è necessario se i binari non possono essere posati direttamente sulla presa di corrente.

Alimentarea electrică flexibilă

Alimentarea electrică flexibilă este necesară atunci când pistele nu pot fi pozate direct prin intermediul racordului electric.

Joustava virtalähde on tarpeen

Joustava virtalähde on tarpeen, jos kiskoja ei voida asentaa suoraan pistorasian yläpuolelle.

Elastyczne zasilani

Elastyczny zasilanie jest wymagane, jeśli szyny nie mogą być układane bezpośrednio nad gniazdem zasilania.

5 Connecteur longitudinal

Relie deux rails entre eux pour des sections droites.

Longitudale verbinder

Verbindt twee sporen voor rechte stukken met elkaar.

Ensamblaje recto

Ensamble dos rieles para tramos rectos entre si.

Connettore longitudinale

Unisce due binari per sezioni rettilinee.

Conector longitudinal

Conectează două piste pentru trasee drepte unele cu altele.

Suora liitin

Yhdistää kaksi kiskoa suoria osuuksia varten.

Przedłużacz

Łączy dwie szyny dla prostych odcinków.

6 Connecteur Flex

Relie deux rails entre eux sous n'importe quel angle et relie le montage au plafond à celui au mur.

Flexibele verbinder

Verbindt twee sporen in een willekeurige hoek met elkaar en maakt de verbinding tussen plafond- en muurmontage mogelijk.

Ensamblaje flexible

Ensamble dos rieles con cualquier ángulo entre si y permite la conexión entre el montaje en techo y paredes.

Connettore flessibile

Collega tra loro due binari con qualsiasi angolazione e consente il collegamento tra il montaggio a soffitto e a parete.

Conector Flex

Conectează două șine într-un unghi aleatoriu între ele și permite conectarea între sistemele de montaj pe plafon și pe perete.

Flex-liitin

Yhdistää kaksi kiskoa mihin tahansa kulmaan ja mahdollistaa yhteyden katto- ja seinäkiinnityksen välillä.

Łącznik elastyczny

Łączy dwie szyny pod dowolnym kątem i umożliwia połączenie między sufitem a ścianą.

7 Connecteur X

Relie quatre rails entre eux à angle droit.

X-verbinder

Verbindt vier sporen in een rechte hoek met elkaar.

Ensamblaje en X

Ensamble cuatro rieles en ángulo recto entre si.

Connettore a X

Collega insieme quattro binari ad angolo retto.

Conector X

Conectează patru șine în unghi drept între ele.

X-liitin

Yhdistää neljä kiskoa suorassa kulmassa toisiinsa nähden.

Łącznik X

Łączy cztery szyny pod kątem prostym.

8 Raccord en L

Relie deux rails entre eux à angle droit.

L-Connector

Verbindt twee sporen in een rechte hoek met elkaar.

Conector en L

Ensamble dos rieles en ángulo recto entre si.

Connettore a L

Collega insieme due binari ad angolo retto.

Conector în L

Conectează două piste pentru trasee în unghi drept unele cu altele.

L-Liitin

Yhdistää kaksi kiskoa toisiinsa suorassa kulmassa.

Złącze L

Łączy dwie szyny pod kątem prostym.

9 Raccord en T

Relie trois rails entre eux à angle droit.

T-Connector

Verbindt drie sporen in een rechte hoek met elkaar.

Conector en T

Ensamble tres rieles en ángulo recto entre si.

Connettore a T

Collega insieme tre binari ad angolo retto.

Conector în T

Conectează trei șine în unghi drept unele de altele.

T-Liitin

Yhdistää kolme kiskoa suorassa kulmassa toisiinsa.

Złącze T

Łączy trzy szyny pod kątem prostym.

10 Isolateur

Grâce à un isolateur, deux circuits séparés peuvent être reliés optiquement pour former un système.

Isolator

Door middel van de isolator kunnen twee aparte stroomkringen optisch verbonden worden tot één systeem.

Aislador

Por medio del aislador pueden conectarse dos circuitos de forma óptica a un sistema.

Isolatore

Utilizzando un isolatore, due circuiti separati possono essere collegati otticamente per formare un sistema.

Izolator

Prin intermediul izolatorului este posibilă conectarea optică a două circuite de comutare într-un sistem.

Eristin

Eristimen avulla kaksi erillistä piiriä voidaan kytkeä optisesti yhden järjestelmän muodostamiseksi.

Izolator

Za pomocą izolatora można optycznie połączyć dwa oddzielne obwody w celu utworzenia systemu.

13 Adaptateur pendulaire

Cet adaptateur pendulaire permet d'intégrer des luminaires suspendus conventionnels dans le système de rail DUOline.

Hangadapter

Deze hangadapter maakt het mogelijk gewone hanglampen in het DUOline-spoorsysteem te integreren.

Adaptador colgante

Este adaptador colgante le permite integrar las lámparas colgantes convencionales en el sistema de rieles de DUOline.

Adattatore per sospensione

Questo adattatore per sospensione consente l'integrazione di lampade a sospensione convenzionali nel sistema a binario DUOline.

Adaptor lustre

Acest adaptor pendular permite integrarea lustrelor uzuale în sistemul de piste DUOline.

Riippuvalaisinsovitin

Tämä riippuvalaisinsovitin mahdollistaa tavallisten riippuvalaisimien integroinnin DUOline-kiskojärjestelmään.

Adapter zawieszania

Ten adapter do zawieszania umożliwia zintegrowanie tradycyjnych lamp wiszących z systemem szyn DUOline.

17 Raccourcisseur de câble

Permet de raccourcir les câbles des luminaires suspendus.

Snoerverkorter

Maakt het inkorten van het snoer van hanglampen mogelijk.

Acortador de cable

Es posible acortar el cable de las lámparas colgantes.

Sistema per accorciare il cavo

Permette di accorciare i cavi delle lampade a sospensione.

Prescurtare cablu

Permite scurtarea cablurilor lustrelor.

Johdon lyhennin

Mahdollistaa riippuvalaisimen johdon lyhentämisen.

Skracacz kabla

Pozwala skrócić kable lamp wiszących.

LED SWITCH DIMMER

Dimmen ohne Dimmer · Dimming without dimmer · Ajuster le niveau d'éclairage sans variateur · Dimmen zonder dimmer · Regulable sin regulador · Dimmerabile senza Dimmer · Ajustarea nivelului de lumina fara variator de lumina · Himmentäminen ilman himmennintä · Ściemnianie bez ściemniacza · Anahtarsız kısma/açma



100%

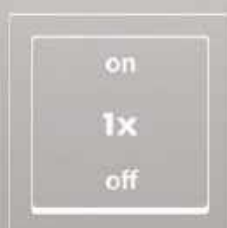

50%

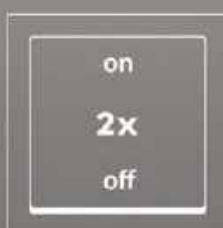

25%



Licht einschalten
Switch on the light
Allumer la lumière
Licht inschakelen
Encender la luz
Accendere la luce
Porniti lumina
Sytytä valot
Włączyć światło
Işıǧı aç

Licht aus- und sofort wieder einschalten
Switch off the light and switch it immediately on again
Éteindre et ré-allumer immédiatement la lumière
Schakel het licht uit en onmiddellijk weer aan
Apagar la luz y encenderla inmediatamente
Spegner la luce e accenderla immediatamente dopo
Inchideti lumina si porniti-o din nou imediat
Sammuta valot ja sytytä välittömästi uudelleen
Wyłącz światło i natychmiast włącz je ponownie
Işıǧı kapatıp, anında tekrar aç

Helligkeit bequem mit jedem herkömmlichen Lichtschalter steuern · Adjusting the desired level of brightness with any conventional light switch · Adapter le niveau d'éclairage avec n'importe quel interrupteur conventionel · Instellen van de gewenste helderheid met elke conventionele schakelaar · Ajuste del nivel de brillo deseado con cualquier interruptor convencional · Variare il livello desiderato di luminosità, con qualsiasi interruttore · Ajustati nivelul dorit de lumina cu orice intrerupator conventional · Valon kirkkauden voi säätää vakiokytkimellä · Komfortowa regulacja jasności przy użyciu dowolnego konwencjonalnego wyłącznika światła · Arzu edilen parlaklık seviyesini herhangi bir anahtar ile ayarlamak





Diese Wandleuchte ist sowohl für den Festanschluss, als auch für den Betrieb mit Steckerzuleitung geeignet.

This wall light is suitable both for a fixed power connection, as well as for the connection of a plug-in power cable.

Cette applique convient à la fois pour une connexion d'alimentation fixe, ainsi que pour la connexion d'un câble d'alimentation enfichable.

Deze wandlamp is zowel geschikt voor een vaste stroomaansluiting als voor het aansluiten van een plug-in voedingskabel.

Esta luz de pared es adecuada tanto para una conexión de alimentación fija como para la conexión por cable de alimentación

Questa lampada da parete è adatta sia per una connessione di alimentazione fissa, sia per la connessione di un cavo di alimentazione plug-in.

Aceasta aplica este potrivita atat pentru a fi montata direct la sursa de curent, dar si pentru a fi conectata printr-un cablu de curent la priza.

Tämä seinävalaisin voidaan asentaa kiinteästi kytkentäriman avulla tai käyttämällä mukana tulevaa liitosjohtoa.

Ta lampa ścienna jest odpowiednia zarówno do podłączenia na stałe, jak również do eksploatacji przy użyciu przewodu z wtyczką.

Seite Page	Artikel-Nr. Product No.	EAN-Nummer EAN-Number	IP IP	Ersatzteile Spare parts	Seite Page	Artikel-Nr. Product No.	EAN-Nummer EAN-Number	IP IP	Ersatzteile Spare parts
219	100800632	4017807388534	IP20	92878	206	208700189	4017807385359	IP20	92920-89
164	101600506	4017807430165	IP20		225	208870132	4017807388473	IP20	
165	101600806	4017807430172	IP20		138	209100107	4017807398564	IP20	S5091-01
317	102000403	4017807387919	IP20		138	209100108	4017807398571	IP20	S5091-01
317	102000405	4017807387926	IP20		170	210200101	4017807394702	IP20	92754-201
231	110300428	4017807369151	IP20		170	210200102	4017807394719	IP20	92754-202
320	110600331	4017807343656	IP20	92712-01	230	210370228	4017807369199	IP20	
320	110600378	4017807343663	IP20	92712-78	597	212400201	4017807408799	IP20	
321	110600531	4017807343670	IP20	92712-01	598	212400207	4017807408850	IP20	
320	110600578	4017807343687	IP20	92712-78	598	212400224	4017807408867	IP20	
233	110700328	4017807354140	IP20	92809	597	212400232	4017807408812	IP20	
232	110700361	4017807354157	IP20	92809-01	594	216070124	4017807212228	IP20	9797
232	110700528	4017807354164	IP20	92809	596	220810201	4017807258363	IP20	92335
232	110700561	4017807354171	IP20	92809-01	596	220810205	4017807258370	IP20	92335
263	110900511	4017807349177	IP20		594	221570207	4017807281170	IP20	
224	118800632	4017807387865	IP20		595	221570228	4017807281187	IP20	
466	200200131	4017807463002	IP20		594	222270231	4017807387414	IP20	
466	200200132	4017807463019	IP20		594	222270232	4017807387421	IP20	
467	200300131	4017807462975	IP20		595	222370231	4017807387025	IP20	
467	200300132	4017807462982	IP20		595	222370232	4017807387032	IP20	
202	200400100	4017807398694	IP20	92860	597	222410205	4017807331349	IP20	
464	200600131	4017807462791	IP20	S2006-01	597	222570207	4017807399899	IP20	
464	200600132	4017807462821	IP20	S2006-02	595	222570231	4017807399875	IP20	
233	200700128	4017807354188	IP20	92809	594	222570232	4017807399882	IP20	
232	200700161	4017807354195	IP20	92809-01	596	222670107	4017807399790	IP20	
219	200800132	4017807388497	IP20	92878	596	222670131	4017807399769	IP20	
469	200970124	4017807211832	IP20	92396	594	222670132	4017807399776	IP20	
460	201000101	4017807409642	IP20		594	222710107	4017807401028	IP20	
460	201100201	4017807409666	IP20		597	222710131	4017807401103	IP20	
203	201200100	4017807398632	IP20	92854	597	222710132	4017807401110	IP20	
460	201400101	4017807409673	IP20		594	223210107	4017807386967	IP20	
165	201600206	4017807430158	IP20		594	223210131	4017807386974	IP20	
194	202000108	4017807436051	IP20	G2020-01	597	223210132	4017807386981	IP20	
194	202000142	4017807432893	IP20	G2020-54	597	223210207	4017807386998	IP20	
421	202400106	4017807244908	IP20	92579	594	223210231	4017807387001	IP20	
200	202500101	4017807364927	IP20	92831-20	594	223210232	4017807387018	IP20	
420	204000106	4017807295672	IP20	92769	597	223310105	4017807371765	IP20	
201	204400101	4017807364972	IP20	92830-22	597	223310131	4017807371772	IP20	
180	204700101	4017807276541	IP20	92717-13	594	223310132	4017807371789	IP20	
228	205300124	4017807403282	IP20		446	223410107	4017807303032	IP20	
228	205300178	4017807411508	IP20		446	223410131	4017807303025	IP20	
238	205570167	4017807442540	IP20		447	223410132	4017807306309	IP20	
238	205570267	4017807442564	IP20		112	223510131	4017807421859	IP20	
428	206400279	4017807364361	IP20		113	223510132	4017807421910	IP20	
428	206500279	4017807364378	IP20		112	223510231	4017807421965	IP20	
459	206600278	4017807364347	IP20		113	223510232	4017807421996	IP20	
268	207000188	4017807356076	IP20		236	223710130	4017807441871	IP20	
154	207500179	4017807382860	IP20		236	223790130	4017807441895	IP20	
154	207500189	4017807382877	IP20		428	223810279	4017807299472	IP20	
205	207700100	4017807385298	IP20	92915	450	223910132	4017807451955	IP20	
208	207800100	4017807189148	IP20	92259-20	450	223910167	4017807441147	IP20	
214	208070131	4017807407235	IP20		429	224110179	4017807329018	IP20	
214	208070132	4017807407242	IP20		429	224110189	4017807329025	IP20	
209	208400106	4017807240184	IP20		444	224210102	4017807465914	IP20	
206	208700179	4017807385342	IP20	92920-79	444	224290102	4017807465921	IP20	

Seite Page	Artikel-Nr. Product No.	EAN-Nummer EAN-Number	IP IP	Ersatzteile Spare parts	Seite Page	Artikel-Nr. Product No.	EAN-Nummer EAN-Number	IP IP	Ersatzteile Spare parts
451	224910231	4017807454413	IP20		455	272570206	4017807352788	IP20	92805
451	224910232	4017807454437	IP20		475	272970401	4017807284652	IP20	
442	225172924	4017807404517	IP20		475	272970487	4017807284669	IP20	
442	225172931	4017807404555	IP20		475	272970701	4017807284676	IP20	
442	225172942	4017807433401	IP20		475	272970787	4017807284683	IP20	
442	225174724	4017807404586	IP20		476	273070401	4017807284690	IP20	
442	225174731	4017807404593	IP20		476	273070701	4017807284706	IP20	
442	225174742	4017807433425	IP20		476	273071301	4017807284713	IP20	
430	225210104	4017807256314	IP20		476	273071801	4017807284720	IP20	
430	225210107	4017807256338	IP20		475	273170301	4017807284737	IP20	
440	225271007	4017807468823	IP20		475	273170387	4017807284744	IP20	
440	225271031	4017807468830	IP20		475	273170401	4017807284751	IP20	
440	225271507	4017807468878	IP20		475	273170487	4017807284768	IP20	
440	225271531	4017807468885	IP20		473	273271201	4017807329087	IP20	
440	225272007	4017807468908	IP20		473	273271801	4017807329094	IP20	
440	225272031	4017807468915	IP20		477	273370307	4017807284799	IP20	
457	225510207	4017807277913	IP20		126	274191005	4017807281927	IP20	
457	225610607	4017807277920	IP20		343	274510107	4017807381559	IP20	
432	225870107	4017807385489	IP20		456	274670105	4017807293968	IP20	
433	225870131	4017807385496	IP20		456	274670205	4017807293975	IP20	
432	225870132	4017807385502	IP20		498	274770107	4017807390049	IP20	
538	227280101	4017807298253	IP20		499	274770132	4017807390056	IP20	
538	227280102	4017807298260	IP20		346	274813005	4017807414790	IP20	
436	229210207	4017807413304	IP20		96	275510207	4017807455830	IP20	
436	229210231	4017807413281	IP20		99	275510231	4017807455816	IP20	
436	229210232	4017807413298	IP20		96	275510232	4017807455823	IP20	
468	2501021-01	4017807130669	IP20	9273-01	136	278070107	4017807405101	IP20	
68	250110231	4017807409499	IP20		136	278070108	4017807405118	IP20	
68	250110232	4017807409505	IP20		363	279570931	4017807450460	IP20	
469	2502211-07	4017807103908	IP20	9413-01	362	279570932	4017807450538	IP20	
64	250810207	4017807464627	IP20		431	279770104	4017807275346	IP20	
64	250810231	4017807464634	IP20		431	279770107	4017807275353	IP20	
64	250810232	4017807464641	IP20		431	279770108	4017807275360	IP20	
468	2522011-06	4017807080797	IP20	92105	648	2803021-06	4017807147599	IP21	9579-01
468	2523011-01	4017807094756	IP20	9327-01	648	2803031-06	4017807147605	IP21	9579
468	2524011-07	4017807067170	IP20	9232	650	281570606	4017807245967	IP44	
65	253310105	4017807464443	IP20		650	281570906	4017807245950	IP44	
65	253310131	4017807464481	IP20		650	281770906	4017807246018	IP44	
65	253310132	4017807464528	IP20		650	281771206	4017807246025	IP44	
72	254700101	4017807395860	IP20		642	282410106	4017807280821	IP44	
66	255410207	4017807415162	IP20		642	282410206	4017807280838	IP44	
66	255410231	4017807419726	IP20		640	282710106	4017807302530	IP44	
458	261100207	4017807351576	IP20		640	282710206	4017807302547	IP44	
152	271170201	4017807247251	IP20	92765-01	644	282990106	4017807345070	IP44	
152	271170202	4017807247268	IP20	92765-02	644	283090106	4017807345087	IP44	
152	271170214	4017807247282	IP20		646	283110106	4017807382846	IP44	
152	271370201	4017807358339	IP20		646	283110206	4017807382853	IP44	
153	271370211	4017807358346	IP20		652	283270106	4017807384048	IP44	
152	271370214	4017807358353	IP20		652	283270206	4017807384055	IP44	
439	271470207	4017807374681	IP20	92940-01	652	283270306	4017807384062	IP44	
439	271470279	4017807374698	IP20	92940-02	646	283370106	4017807391824	IP44	92888
140	271970601	4017807337280	IP20		646	283370107	4017807384185	IP44	92888
140	271970611	4017807337297	IP20		646	283370206	4017807395198	IP44	92888
501	272470107	4017807358360	IP20		646	283370207	4017807395204	IP44	92888
500	272470108	4017807358377	IP20		202	300400200	4017807400915	IP20	92859

Seite Page	Artikel-Nr. Product No.	EAN-Nummer EAN-Number	IP IP	Ersatzteile Spare parts	Seite Page	Artikel-Nr. Product No.	EAN-Nummer EAN-Number	IP IP	Ersatzteile Spare parts
226	300500104	4017807267112	IP20		146	303600132	4017807454772	IP20	S3136-44
226	300500107	4017807262421	IP20		146	303600407	4017807454727	IP20	S3136-11
226	300500109	4017807262438	IP20		146	303600432	4017807454710	IP20	S3136-44
189	300600331	4017807467338	IP20	G30062-52	147	303690307	4017807451078	IP20	S3136-11
188	300600342	4017807467345	IP20	G30062-54	146	303690332	4017807451061	IP20	S3136-44
277	300700101	4017807298659	IP20		281	303700104	4017807286601	IP20	
277	300700102	4017807298666	IP20		281	303700161	4017807286618	IP20	
218	300800132	4017807388541	IP20	92878	281	303700162	4017807286625	IP20	
218	300800432	4017807388558	IP20	92878	272	303800102	4017807286540	IP20	92740
276	300900101	4017807298673	IP20		272	303800161	4017807286557	IP20	92740
276	300900102	4017807298680	IP20		272	303800162	4017807286564	IP20	92740
251	301000167	4017807478143	IP20	G3010-52	273	303800517	4017807292503	IP20	92740
250	301000367	4017807478167	IP20	G3010-52	335	304100100	4017807247411	IP20	
306	301100178	4017807293500	IP20		335	304100106	4017807247404	IP20	
306	301100378	4017807293517	IP20		255	304300132	4017807467499	IP20	
203	301200300	4017807398649	IP20	92855	255	304300432	4017807467567	IP20	
322	301300142	4017807390322	IP20		255	304330332	4017807467512	IP20	
322	301300342	4017807390346	IP20		201	304400201	4017807364989	IP20	92830-040
323	301300442	4017807390353	IP20		275	304500104	4017807286151	IP20	92740
334	301400101	4017807195422	IP20	92270-01	275	304500161	4017807286168	IP20	92740
334	301400112	4017807195446	IP20	92270-12	275	304500162	4017807286175	IP20	92740
334	301400115	4017807195453	IP20	92270-15	181	304700101	4017807275667	IP20	92717-17
334	301400124	4017807195651	IP20	92270-24	180	304700301	4017807275681	IP20	92717-17
199	301500407	4017807388886	IP20		181	304790101	4017807275674	IP20	92717-23
191	301600106	4017807343816	IP20	92876-06	312	304800100	4017807277937	IP20	92720-00
190	301600107	4017807343809	IP20	92876-07	312	304800142	4017807277944	IP20	92720-42
191	301690106	4017807349184	IP20	92810	312	304900100	4017807277951	IP20	92721-00
190	301690107	4017807349191	IP20	92810-01	312	304900142	4017807277968	IP20	92721-42
333	301700107	4017807196009	IP20	9408-01	249	305000430	4017807353792	IP20	
333	301700108	4017807196016	IP20	9408-01	279	305100161	4017807330533	IP20	
326	301800107	4017807262537	IP20	92700	279	305100162	4017807330540	IP20	
332	301900107	4017807299311	IP20	92295	328	305170107	4017807414424	IP20	
195	302000308	4017807436112	IP20	G2020-01	328	305170131	4017807412956	IP20	
194	302000342	4017807433067	IP20	G2020-54	328	305170132	4017807412963	IP20	
260	302100130	4017807451252	IP20	S30211-01	329	305170167	4017807440393	IP20	
261	302100430	4017807451269	IP20	S30212-01	175	305200179	4017807281064	IP20	92728-79
332	302400106	4017807301045	IP20	92780	174	305200189	4017807281071	IP20	92728-89
200	302500301	4017807364934	IP20		174	305200379	4017807287066	IP20	92727-79
274	302700102	4017807286526	IP20		174	305200389	4017807287073	IP20	92727-89
265	302900102	4017807292497	IP20	92779	328	305270107	4017807414448	IP20	
258	303000132	4017807476781	IP20		328	305270131	4017807414455	IP20	
259	303000232	4017807468069	IP20		328	305270132	4017807414462	IP20	
258	303090132	4017807476798	IP20		175	305290179	4017807287042	IP20	92727-79
327	303100104	4017807353310	IP20	92812	174	305290189	4017807287059	IP20	92727-89
327	303100107	4017807353327	IP20	92812	229	305300124	4017807401721	IP20	
221	303201531	4017807399479	IP20		228	305300178	4017807411515	IP20	
220	303201532	4017807399509	IP20		228	305300224	4017807401738	IP20	
149	303300101	4017807288292	IP20		228	305300278	4017807411522	IP20	
149	303300102	4017807288308	IP20		247	305300488	4017807445237	IP20	
149	303300114	4017807288315	IP20	92837-14	158	305400401	4017807336948	IP20	
242	303400167	4017807425376	IP20		158	305400411	4017807336955	IP20	
243	303400367	4017807425383	IP20		158	305400441	4017807391022	IP20	
112	303500331	4017807422061	IP20		158	305400479	4017807336962	IP20	
112	303500332	4017807422078	IP20		158	305400489	4017807336979	IP20	
146	303600107	4017807454789	IP20	S3136-11	328	305470107	4017807414431	IP20	

Seite Page	Artikel-Nr. Product No.	EAN-Nummer EAN-Number	IP IP	Ersatzteile Spare parts	Seite Page	Artikel-Nr. Product No.	EAN-Nummer EAN-Number	IP IP	Ersatzteile Spare parts
328	305470131	4017807412970	IP20		108	308900231	4017807425550	IP20	
328	305470132	4017807412987	IP20		108	308900242	4017807425574	IP20	
238	305500467	4017807441093	IP20		108	308900331	4017807405224	IP20	
196	305600106	4017807407723	IP20		108	308900342	4017807425451	IP20	
197	305600406	4017807407730	IP20		111	308900631	4017807425581	IP20	
324	305700179	4017807329148	IP20		110	308900642	4017807425604	IP20	
314	305900126	4017807330816	IP20		240	309000167	4017807473421	IP20	
314	305900130	4017807330809	IP20		241	309000267	4017807466812	IP20	
169	306100131	4017807355772	IP20	92749-331	240	309090167	4017807473414	IP20	
167	306100132	4017807355789	IP20	92749-332	308	309200132	4017807473773	IP20	
169	306190131	4017807355802	IP20	92749-531	308	309200432	4017807473803	IP20	
167	306190132	4017807355819	IP20	92749-532	309	309230332	4017807473797	IP20	
211	306200831	4017807477054	IP20		318	309300301	4017807354058	IP20	92836-04
210	306200832	4017807467864	IP20						92836-05
324	306400179	4017807286465	IP20						92836-06
144	306500107	4017807280975	IP20						92836-07
216	306700632	4017807364392	IP20		318	309300302	4017807354102	IP20	92836-04
217	306700732	4017807399905	IP20						92836-05
278	306900161	4017807351767	IP20						92836-06
278	306900162	4017807356816	IP20						92836-07
268	307000188	4017807356090	IP20		160	309400317	4017807423723	IP20	
269	307000688	4017807356106	IP20		114	309800431	4017807387681	IP20	
335	307290101	4017807343748	IP20		115	309800432	4017807387698	IP20	
305	307400331	4017807408010	IP20		222	309900631	4017807330946	IP20	
154	307500179	4017807382884	IP20		223	309900632	4017807330953	IP20	
155	307500189	4017807382891	IP20		264	310100104	4017807408607	IP20	
154	307500279	4017807395303	IP20		266	310100106	4017807412536	IP20	
154	307500289	4017807395341	IP20		266	310100107	4017807395259	IP20	
184	307601006	4017807423198	IP20	G5076-54	266	310100108	4017807395266	IP20	
185	307601007	4017807423204	IP20	G5076-01	266	310100161	4017807356014	IP20	
183	307601206	4017807426861	IP20	G50761-54	266	310100162	4017807356021	IP20	
182	307601207	4017807426878	IP20	G50761-01	264	310100204	4017807408591	IP20	
205	307700300	4017807385304	IP20	92919	267	310100561	4017807356038	IP20	
208	307800100	4017807189155	IP20	92258-30	267	310100562	4017807356045	IP20	
208	307804100	4017807190083	IP20	92258-40	213	310400631	4017807455502	IP20	
324	308000132	4017807288827	IP20		212	310400632	4017807455526	IP20	
253	308100567	4017807451221	IP20		193	310600132	4017807427264	IP20	G0106-54
157	308200179	4017807392517	IP20		192	310600432	4017807427288	IP20	G0106-54
157	308200189	4017807392524	IP20		192	310630332	4017807435696	IP20	G0106-54
209	308400206	4017807240191	IP20		262	310900111	4017807349160	IP20	
186	308500531	4017807468618	IP20	G40342-52	163	311210506	4017807367768	IP20	92829-40
186	308500542	4017807468601	IP20	G40342-54					92833-10
187	308590331	4017807468632	IP20	G40342-52					92833-12
186	308590342	4017807468625	IP20	G40342-54					92833-14
316	308600706	4017807378306	IP20		162	311210606	4017807367775	IP20	92829-50
206	308700179	4017807385366	IP20	92925-79					92833-10
206	308700189	4017807385373	IP20	92925-89					92833-12
206	308700279	4017807385380	IP20	92924-79					92833-14
206	308700289	4017807385397	IP20	92924-89					92833-16
207	308700379	4017807385403	IP20	92925-79	594	312400101	4017807408713	IP20	
207	308700389	4017807385410	IP20	92925-89	596	312400107	4017807408737	IP20	
177	308800131	4017807394665	IP20	92752-4031	596	312400124	4017807408744	IP20	
176	308800132	4017807394672	IP20	92752-4032	594	312400132	4017807408720	IP20	
176	308890131	4017807394689	IP20	92752-5531	595	312400401	4017807408751	IP20	
176	308890132	4017807394696	IP20	92752-5532	594	312400407	4017807408775	IP20	

Seite Page	Artikel-Nr. Product No.	EAN-Nummer EAN-Number	IP IP	Ersatzteile Spare parts	Seite Page	Artikel-Nr. Product No.	EAN-Nummer EAN-Number	IP IP	Ersatzteile Spare parts
594	312400424	4017807408782	IP20		333	3407011-07	4017807103724	IP20	9408-01
595	312400432	4017807408768	IP20		337	3490400-00	4017807062465	IP20	
172	315200109	4017807288001	IP20	92735-09	336	3490400-15	4017807254723	IP20	
173	315200179	4017807287998	IP20	92735-79	336	3490400-18	4017807081527	IP20	
172	315200189	4017807288018	IP20	92735-89	336	3490400-19	4017807254716	IP20	
178	315300106	4017807301212	IP20	92737-01	337	3490500-00	4017807062472	IP20	
178	315390106	4017807301205	IP20	92736-01	336	3491400-00	4017807081541	IP20	
140	320910101	4017807330823	IP20		46	350810507	4017807415056	IP20	92893
141	320910111	4017807337181	IP20						92894
116	321210107	4017807454000	IP20						92895
117	321210108	4017807461145	IP20		47	350810607	4017807415070	IP20	92893
285	321611131	4017807468724	IP20						92894
284	321611132	4017807468731	IP20						92895
284	321691131	4017807468748	IP20		70	351610107	4017807389807	IP20	
284	321691132	4017807468755	IP20		70	351690107	4017807389814	IP20	
80	321710107	4017807430486	IP20		45	352710307	4017807453775	IP20	
81	321710142	4017807430493	IP20		44	352710342	4017807473308	IP20	
87	321810307	4017807430462	IP20		72	354790101	4017807395884	IP20	
86	321810342	4017807430479	IP20		60	358210107	4017807389784	IP20	
288	321910207	4017807453560	IP20		61	358210131	4017807389791	IP20	
288	321910242	4017807453577	IP20		336	3590010-01	4017807062496	IP20	
289	321910307	4017807453584	IP20		89	370410231	4017807435122	IP20	
288	321910342	4017807453607	IP20		123	370910606	4017807330670	IP20	
104	322610231	4017807424317	IP20		611	371010307	4017807281750	IP20	92734-01
104	322610232	4017807424324	IP20		611	371010308	4017807281767	IP20	92734-01
104	322610431	4017807424294	IP20		611	371010407	4017807281781	IP20	92734-01
104	322610432	4017807424300	IP20		611	371010408	4017807281798	IP20	92734-01
93	323210442	4017807460179	IP20		78	371310105	4017807445336	IP20	
310	323310306	4017807407372	IP20		79	371310142	4017807445343	IP20	
311	323310332	4017807412239	IP20		78	371310131	4017807451801	IP20	
310	323390306	4017807407365	IP20		607	371510407	4017807285017	IP20	92739
310	323390332	4017807412222	IP20		128	371610307	4017807391275	IP20	
237	323710130	4017807451191	IP20		129	371610331	4017807391282	IP20	
100	324610131	4017807472912	IP20		128	371690307	4017807391251	IP20	
101	324610132	4017807470932	IP20		128	371690331	4017807391268	IP20	
103	324610179	4017807470949	IP20		302	371710142	4017807456608	IP20	
612	324810407	4017807257649	IP20	98249	303	371710187	4017807456615	IP20	
				98248	130	372294505	4017807297546	IP20	
612	324810428	4017807257854	IP20	98249	90	372610331	4017807377460	IP20	
				98248	121	372910106	4017807299267	IP20	
82	325010105	4017807422627	IP20		127	374112505	4017807281934	IP20	
83	325010132	4017807422634	IP20		298	374210406	4017807288391	IP20	
287	325110131	4017807467758	IP20		330	3751031-07	4017807137729	IP20	9350
286	325110132	4017807467789	IP20		330	3751031-24	4017807182255	IP20	9350-24
286	325110179	4017807467796	IP20		331	3751041-07	4017807137736	IP20	9350
300	325510407	4017807367973	IP20	92833	330	3751041-24	4017807181081	IP20	9350-24
301	325510507	4017807367980	IP20	92833	330	3751051-07	4017807169027	IP20	9350
290	325610305	4017807388022	IP20		330	3751051-24	4017807181098	IP20	9350-24
84	325710207	4017807473186	IP20		295	375310507	4017807472226	IP20	
85	325710231	4017807468519	IP20		294	375310532	4017807472233	IP20	
84	325710242	4017807468557	IP20		294	375310508	4017807481839	IP20	
134	328210406	4017807256352	IP20		97	375510407	4017807469844	IP20	
107	329010107	4017807423396	IP20		98	375510431	4017807469868	IP20	
106	329010132	4017807423402	IP20		96	375510432	4017807469882	IP20	
274	340100162	4017807334456	IP20	92814-01	292	376013606	4017807282085	IP20	

Seite Page	Artikel-Nr. Product No.	EAN-Nummer EAN-Number	IP IP	Ersatzteile Spare parts	Seite Page	Artikel-Nr. Product No.	EAN-Nummer EAN-Number	IP IP	Ersatzteile Spare parts
119	376310406	4017807298918	IP20		182	407690907	4017807423167	IP20	G5076-01
325	376410402	4017807280906	IP20		252	407700114	4017807298758	IP20	
299	377310307	4017807274622	IP20	92707	514	407800132	4017807303216	IP20	
298	377690105	4017807296280	IP20		214	408000131	4017807407297	IP20	
136	378010307	4017807391152	IP20	92871	215	408000132	4017807407303	IP20	
136	378010308	4017807391169	IP20	92872	156	408200179	4017807392593	IP20	
136	378010407	4017807391176	IP20	92871	157	408290179	4017807392616	IP20	
137	378010408	4017807391183	IP20	92872	187	408500531	4017807468663	IP20	G40342-52
132	378310106	4017807336788	IP20		186	408500542	4017807468670	IP20	G40342-54
293	379090505	4017807282245	IP20		225	408800332	4017807390148	IP20	
296	379190707	4017807362831	IP20		108	408900331	4017807420838	IP20	
296	379190779	4017807370829	IP20		109	408900342	4017807425499	IP20	
297	379190732	4017807471229	IP20		240	409000167	4017807466843	IP20	
124	379890307	4017807372984	IP20		139	409100307	4017807389654	IP20	
523	400200107	4017807368390	IP20		138	409100308	4017807389661	IP20	
522	400200108	4017807378320	IP20		262	410900111	4017807354904	IP20	
513	400400107	4017807423211	IP20	S4004-11	163	411210406	4017807367836	IP20	92829-40
512	400400132	4017807423228	IP20	S4004-11					92833-10
227	400500104	4017807268621	IP20						92833-12
227	400500107	4017807268638	IP20						92833-14
227	400500109	4017807268645	IP20		485	4200011-06	4017807105650	IP20	913240
149	401100101	4017807276121	IP20	92782-01	504	420490107	4017807295337	IP20	9243-01
149	401100102	4017807276138	IP20	92782-02	504	420490132	4017807382525	IP20	9243-01
149	401100114	4017807276145	IP20	92782-14	503	420810107	4017807367614	IP20	
199	401500307	4017807388879	IP20		502	420910107	4017807367591	IP20	
195	402000108	4017807436099	IP20	G4020-01	502	420910108	4017807367607	IP20	
194	402000142	4017807433012	IP20	G4020-54	524	421100301	4017807194494	IP20	92287S-01
600	402500378	4017807353822	IP20		524	421100302	4017807194500	IP20	92287S-02
259	403000132	4017807468076	IP20		116	421210107	4017807454024	IP20	
245	403400167	4017807426854	IP20		117	421210108	4017807461169	IP20	
527	403400317	4017807422986	IP20	G40341-13 G40342-19 G40343-54	80	421710107	4017807434323	IP20	
526	403400354	4017807422948	IP20	G40341-54 G40342-54 G40343-54	81	421710142	4017807434316	IP20	
242	403490167	4017807430226	IP20		494	421910207	4017807267532	IP20	92685 92685-01
506	4035011-04	4017807090604	IP20	92174	494	421910228	4017807267549	IP20	92685 92685-01
506	4035011-07	4017807090611	IP20	92174	500	422410107	4017807358599	IP20	
506	4035011-08	4017807090628	IP20	92174	500	422410108	4017807358605	IP20	
525	403900201	4017807433654	IP20	S40391-01 S40392-01	105	422610531	4017807423822	IP20	
525	403900211	4017807433661	IP20	S40391-11 S40392-11	104	422610532	4017807423853	IP20	
271	404200188	4017807354874	IP20		490	422710307	4017807343076	IP20	
255	404300332	4017807467727	IP20		491	422710308	4017807354270	IP20	
239	405500367	4017807466751	IP20		509	422970206	4017807368260	IP20	92946 92821
210	406200532	4017807467901	IP20		488	423010204	4017807467451	IP20	
145	406500107	4017807280982	IP20		489	423010207	4017807467444	IP20	
216	406700632	4017807364415	IP20		488	423010208	4017807478242	IP20	
268	407000188	4017807356113	IP20		488	423010232	4017807467468	IP20	
515	407400179	4017807357882	IP20		93	423210542	4017807460155	IP20	
154	407500179	4017807382921	IP20		497	423510101	4017807345032	IP20	
155	407500189	4017807382938	IP20		486	424210304	4017807467635	IP20	
183	407690906	4017807423150	IP20	G5076-54	487	424210307	4017807467628	IP20	
					486	424210308	4017807478259	IP20	
					486	424210332	4017807467598	IP20	
					100	424610131	4017807472899	IP20	

Seite Page	Artikel-Nr. Product No.	EAN-Nummer EAN-Number	IP IP	Ersatzteile Spare parts	Seite Page	Artikel-Nr. Product No.	EAN-Nummer EAN-Number	IP IP	Ersatzteile Spare parts
101	424610132	4017807470833	IP20		119	476310206	4017807298956	IP20	
102	424610179	4017807470901	IP20		132	478310206	4017807336795	IP20	
613	424810107	4017807257687	IP20	98249 98248	133	478310506	4017807336801	IP20	
613	424810128	4017807257861	IP20	98249 98248	507	478610307	4017807287837	IP20	92766
613	424810207	4017807257700	IP20	98249 98248	124	479890307	4017807372953	IP20	
613	424810228	4017807257878	IP20	98249 98248	522	500200107	4017807368406	IP20	92819
496	424910207	4017807353938	IP20		522	500200108	4017807378313	IP20	92819
492	426410207	4017807244717	IP20		227	500500104	4017807268669	IP20	
492	426410208	4017807244724	IP20		227	500500107	4017807268676	IP20	
480	426511807	4017807473407	IP20		227	500500109	4017807268683	IP20	
480	426511831	4017807467376	IP20		233	500700128	4017807354201	IP20	92809
481	426511832	4017807467390	IP20		232	500700161	4017807354218	IP20	92809-01
482	427511801	4017807274332	IP20		149	501100101	4017807246810	IP20	
482	427511802	4017807274349	IP20		149	501100102	4017807246827	IP20	
482	427511887	4017807279511	IP20		149	501100114	4017807246834	IP20	
95	427710532	4017807442205	IP20		191	501600106	4017807390858	IP20	
94	427710505	4017807451672	IP20		190	501600107	4017807390865	IP20	
584	427890331	4017807383874	IP20	S8278-01	194	502000108	4017807436075	IP20	G2020-01
584	427890332	4017807383881	IP20	S8278-01	194	502000142	4017807432992	IP20	G2020-54
134	428210206	4017807256390	IP20		260	502100130	4017807473476	IP20	S30212-01
107	429010107	4017807423433	IP20		274	502700102	4017807286533	IP20	92741
106	429010132	4017807423440	IP20		545	5027011-01	4017807017366	IP20	
493	429110104	4017807267518	IP20	92694	545	5027011-17	4017807051360	IP20	
493	429110107	4017807267525	IP20	92694	545	5027011-47	4017807124941	IP20	
484	429910107	4017807273984	IP20		545	5028010-01	4017807051414	IP20	
47	450810407	4017807415131	IP20	92893 92894 92895	545	5028010-02	4017807051421	IP20	
59	451850101	4017807407464	IP20		545	5028010-17	4017807051438	IP20	
495	4602021-24	4017807196801	IP20	92274 92274-01	545	5028010-47	4017807051445	IP20	
148	461100101	4017807247220	IP20	92597-01	544	5029010-01	4017807051377	IP20	
148	461100102	4017807247237	IP20	92597-02	544	5029010-17	4017807051391	IP20	
148	461100114	4017807247244	IP20	92597-14	544	5029010-47	4017807051407	IP20	
518	462100131	4017807398915	IP20	S4621-01	280	503500104	4017807286724	IP20	92742
519	462100132	4017807398922	IP20	S4621-02	280	503500161	4017807286731	IP20	92742
516	467400102	4017807358988	IP20	92808	280	503500162	4017807286748	IP20	92742
122	470910406	4017807330632	IP20		281	503700104	4017807286632	IP20	
130	472290105	4017807305753	IP20		281	503700161	4017807286649	IP20	
91	472610531	4017807387643	IP20		281	503700162	4017807286656	IP20	
120	472910106	4017807299281	IP20		272	503800102	4017807286571	IP20	92740
505	473190307	4017807302691	IP20		272	503800161	4017807286588	IP20	92740
505	473190331	4017807302707	IP20		272	503800162	4017807286595	IP20	92740
505	473190332	4017807382532	IP20		257	504300132	4017807467703	IP20	
126	474112505	4017807281941	IP20		168	506100131	4017807355826	IP20	92749-331
517	474410179	4017807359633	IP20		167	506100132	4017807355833	IP20	92749-332
498	474790107	4017807390087	IP20		168	506190131	4017807355840	IP20	92749-531
499	474790132	4017807390094	IP20		167	506190132	4017807355857	IP20	92749-532
520	475310307	4017807380439	IP20		144	506500107	4017807280999	IP20	
521	475310379	4017807380446	IP20		268	507000188	4017807356120	IP20	
511	475410207	4017807398595	IP20	S4754-01	154	507500179	4017807382945	IP20	
					154	507500189	4017807382952	IP20	
					184	507690606	4017807423112	IP20	G5076-54
					184	507690607	4017807423143	IP20	G5076-01
					252	507700114	4017807298727	IP20	
					514	507800132	4017807329179	IP20	
					214	508000131	4017807407273	IP20	
					215	508000132	4017807407280	IP20	

Seite Page	Artikel-Nr. Product No.	EAN-Nummer EAN-Number	IP IP	Ersatzteile Spare parts	Seite Page	Artikel-Nr. Product No.	EAN-Nummer EAN-Number	IP IP	Ersatzteile Spare parts
156	508200179	4017807392555	IP20		547	527590132	4017807480313	IP20	92825
543	508300131	4017807422313	IP20		536	527690131	4017807372304	IP20	
542	508300132	4017807422337	IP20		536	527690132	4017807372311	IP20	
270	508400132	4017807387438	IP20	G5040-02	95	527710332	4017807442229	IP20	
270	508400161	4017807387445	IP20	G5040-02	94	527710305	4017807451665	IP20	
270	508400162	4017807387452	IP20		540	527810101	4017807274356	IP20	
177	508800131	4017807394641	IP20	92752-4031	540	527810107	4017807275025	IP20	
176	508800132	4017807394658	IP20	92752-4032	529	527920101	4017807276046	IP20	
110	508900231	4017807425512	IP20		528	527920102	4017807276053	IP20	
110	508900242	4017807425536	IP20		533	528020101	4017807409314	IP20	
138	509100107	4017807398540	IP20	S5091-01	532	528020142	4017807411683	IP20	
138	509100108	4017807398557	IP20	S5091-01	134	528210106	4017807256413	IP20	
309	509200132	4017807473759	IP20		540	528310107	4017807244564	IP20	
192	510600132	4017807427240	IP20	G0106-54	540	528380107	4017807245899	IP20	
262	510900111	4017807354898	IP20		550	529310107	4017807262018	IP20	92672-07
149	511100101	4017807246841	IP20	92807-01	550	529690100	4017807262032	IP20	92671-00
149	511100102	4017807246858	IP20		550	529690107	4017807262070	IP20	92671-07
149	511100114	4017807246865	IP20		551	529990103	4017807248340	IP20	92584
163	511210306	4017807367829	IP20	92829-28 92833-10 92833-12	551	529990107	4017807248364	IP20	92584
178	515300106	4017807301236	IP20	92736-01	46	550810207	4017807415117	IP20	92894 92895
504	520490107	4017807295344	IP20	9243-01	70	551610107	4017807389821	IP20	
502	520910107	4017807367577	IP20		74	551753001	4017807407440	IP44	
502	520910108	4017807367584	IP20		74	551754001	4017807407457	IP44	
116	521210107	4017807454017	IP20		144	556500107	4017807281002	IP20	
116	521210108	4017807461152	IP20		122	570990206	4017807330649	IP20	
87	521810207	4017807430448	IP20		500	572410107	4017807337006	IP20	
86	521810242	4017807430455	IP20		500	572410108	4017807345162	IP20	
534	522520101	4017807226768	IP20		120	572910106	4017807303162	IP20	
534	522520102	4017807226775	IP20		581	573190107	4017807302677	IP20	
534	522520187	4017807226782	IP20		583	573190131	4017807302684	IP20	
104	522610331	4017807423792	IP20		541	573910101	4017807275636	IP20	92839
104	522610332	4017807423815	IP20		541	573910106	4017807275650	IP20	92839
92	523210242	4017807460117	IP20		554	574090107	4017807268973	IP20	92679-01
613	524810107	4017807257663	IP20	98249 98248	517	574410179	4017807359626	IP20	
613	524810128	4017807257885	IP20	98249 98248	498	574790107	4017807390063	IP20	
531	525410132	4017807457124	IP20		498	574790132	4017807390070	IP20	
530	525410187	4017807457148	IP20		520	575310307	4017807380453	IP20	
549	525490106	4017807371710	IP20	92826	521	575310379	4017807380460	IP20	
549	525490107	4017807371727	IP20	92826	510	575410207	4017807398588	IP20	S5754-01
535	525690101	4017807372342	IP20		119	576390206	4017807298949	IP20	
546	525790107	4017807385663	IP20	92876	125	576410806	4017807287257	IP20	
546	525790108	4017807385670	IP20	92876	136	578090107	4017807391190	IP20	92871
546	525790132	4017807385687	IP20	92876-32	136	578090108	4017807391206	IP20	92872
541	527090111	4017807372328	IP20		548	579790104	4017807275285	IP20	
541	527090131	4017807372335	IP20		548	579790107	4017807275322	IP20	
538	527290101	4017807291438	IP20		548	579790108	4017807275339	IP20	
538	527290102	4017807291445	IP20		124	579890307	4017807372960	IP20	
537	527410101	4017807291452	IP20		554	5900011-07	4017807108033	IP20	9424
537	527410142	4017807291513	IP20		554	5901011-07	4017807108057	IP20	9426
546	527590107	4017807371758	IP20	92825	554	5908011-07	4017807135749	IP20	9262-01
546	527590179	4017807373103	IP20	92825	557	5914011-01	4017807150445	IP20	92281-01
					557	5914011-02	4017807150452	IP20	92281
					557	5914011-42	4017807150476	IP20	92281-42
					550	592000107	4017807166705	IP20	9704

Seite Page	Artikel-Nr. Product No.	EAN-Nummer EAN-Number	IP IP	Ersatzteile Spare parts	Seite Page	Artikel-Nr. Product No.	EAN-Nummer EAN-Number	IP IP	Ersatzteile Spare parts
551	5922011-07	4017807081770	IP20	9309	462	603390101	4017807433807	IP20	
552	5925011-07	4017807094985	IP20	9321	462	603400101	4017807433791	IP20	
552	5925011-08	4017807094992	IP20	9321	462	603490101	4017807433814	IP20	
552	5930011-01	4017807112788	IP20	9395	112	603500331	4017807422047	IP20	
552	5930011-24	4017807112801	IP20	9396	112	603500332	4017807422054	IP20	
555	593900100	4017807224603	IP20	92496	427	603800287	4017807294088	IP20	
159	595400101	4017807337778	IP20		427	603800487	4017807294118	IP20	
159	595400111	4017807337785	IP20		150	603900201	4017807289688	IP20	92631-30
159	595400141	4017807391046	IP20		150	603900202	4017807289695	IP20	92631-30
159	595400179	4017807337792	IP20		150	603900214	4017807289701	IP20	92631-30
159	595400189	4017807337808	IP20		150	603900301	4017807256536	IP20	92662
555	595500106	4017807154528	IP20	9610-01	150	603900302	4017807256543	IP20	92662-02
555	595500107	4017807154535	IP20	9610-00	150	603900314	4017807256550	IP20	92662-14
555	595500108	4017807156454	IP20	9610-00	150	603900501	4017807369298	IP20	
557	5960011-01	4017807149609	IP20	92282	150	603900502	4017807369304	IP20	
209	598400106	4017807240214	IP20		150	603900514	4017807369311	IP20	
553	599000106	4017807195958	IP20	92271-06	420	604000106	4017807295689	IP20	92769-25
553	599000107	4017807195965	IP20	92271-07	420	604000206	4017807295696	IP20	92769-30
553	599000108	4017807195972	IP20	92271-07	421	604200206	4017807293869	IP20	92776-01
553	599000118	4017807195989	IP20	92271-18	201	604400101	4017807364996	IP20	92830-30
553	599000124	4017807195996	IP20	92271-07	201	604400201	4017807365009	IP20	92830-40
556	599600101	4017807256055	IP20	92934-01	201	604400301	4017807365016	IP20	92830-50
556	599600102	4017807257472	IP20	92934-02	383	604900331	4017807454284	IP20	
556	599600115	4017807256086	IP20		382	604900332	4017807454307	IP20	
556	599600119	4017807257793	IP20		383	604900631	4017807454345	IP20	
556	599600142	4017807256093	IP20		382	604900632	4017807454369	IP20	
202	600400100	4017807398656	IP20	92856	158	605400501	4017807349214	IP20	
202	600400200	4017807398663	IP20	92857	158	605400511	4017807349221	IP20	
202	600400300	4017807398670	IP20	92858	158	605400541	4017807391039	IP20	
188	600600331	4017807467352	IP20	G30062-52	158	605400579	4017807349238	IP20	
188	600600342	4017807467369	IP20	G30062-54	159	605400589	4017807349245	IP20	
232	600700328	4017807354225	IP20	92809	238	605500467	4017807442588	IP20	
232	600700361	4017807354232	IP20	92809-01	418	605600307	4017807236996	IP20	92529
218	600800532	4017807388527	IP20	92878	196	605600506	4017807407716	IP20	
203	601200100	4017807398601	IP20	92851	418	605600507	4017807237009	IP20	92529
203	601200200	4017807398618	IP20	92852	169	606100231	4017807394504	IP20	92755-431
203	601200300	4017807398625	IP20	92853	166	606100232	4017807394511	IP20	92755-432
422	601400106	4017807224580	IP20	92460	169	606100331	4017807394528	IP20	92755-531
198	601500507	4017807388862	IP20		166	606100332	4017807394535	IP20	92755-532
423	602100100	4017807223569	IP20	92465	459	606600178	4017807364354	IP20	
423	602100200	4017807223576	IP20	92465-02	216	606700632	4017807373448	IP20	
426	602300101	4017807415261	IP20	S60231-01	278	606900161	4017807351781	IP20	
426	602300145	4017807415285	IP20	S60231-45	278	606900162	4017807356823	IP20	
426	602300194	4017807415292	IP20	S60231-94	184	607601006	4017807423174	IP20	G5076-54
426	602300301	4017807399578	IP20	S60232-01	184	607601007	4017807423181	IP20	G5076-01
426	602300345	4017807399585	IP20	S60232-45	182	607601206	4017807426885	IP20	G50761-54
426	602300394	4017807399592	IP20	S60232-94	182	607601207	4017807426892	IP20	G50761-01
421	602400106	4017807244915	IP20	92579-25	204	607700100	4017807385311	IP20	92916
421	602400206	4017807244922	IP20	92579-30	204	607700200	4017807385328	IP20	92917
200	602500101	4017807364941	IP20	92831-30	204	607700300	4017807385335	IP20	92918
200	602500201	4017807364958	IP20	92831-40	208	607800100	4017807189216	IP20	92259-30
200	602500301	4017807364965	IP20	92831-50	214	608000331	4017807412598	IP20	
220	603201031	4017807399516	IP20		214	608000332	4017807412604	IP20	
220	603201032	4017807399523	IP20		424	608100224	4017807211795	IP20	92472-01
462	603300101	4017807433784	IP20		424	608100324	4017807211788	IP20	92472

Seite Page	Artikel-Nr. Product No.	EAN-Nummer EAN-Number	IP IP	Ersatzteile Spare parts	Seite Page	Artikel-Nr. Product No.	EAN-Nummer EAN-Number	IP IP	Ersatzteile Spare parts
156	608200279	4017807392531	IP20		116	621210108	4017807461121	IP20	
206	608700179	4017807385427	IP20	92921-79	116	621290107	4017807453997	IP20	
206	608700189	4017807385434	IP20	92921-89	116	621290108	4017807461138	IP20	
206	608700279	4017807385441	IP20	92922-79	579	621410505	4017807220940	IP20	92426
206	608700289	4017807385458	IP20	92922-89	80	621710107	4017807430509	IP20	
206	608700379	4017807385465	IP20	92923-79	80	621710142	4017807430516	IP20	
206	608700389	4017807385472	IP20	92923-89	143	621911201	4017807337105	IP20	
224	608800632	4017807387889	IP20		143	621911211	4017807337112	IP20	
110	608900331	4017807413717	IP20		143	621912401	4017807337143	IP20	
109	608900342	4017807425475	IP20		143	621912411	4017807337150	IP20	
419	609000306	4017807174021	IP20	9703	142	621914001	4017807384468	IP20	
160	609400317	4017807423730	IP20		142	621914011	4017807384475	IP20	
419	609700306	4017807196481	IP20	92324	142	621915501	4017807384482	IP20	
114	609800431	4017807387704	IP20		142	621915511	4017807384499	IP20	
114	609800432	4017807387711	IP20		105	622610431	4017807424270	IP20	
222	609900331	4017807330960	IP20		104	622610432	4017807424287	IP20	
222	609900332	4017807330984	IP20		376	622713007	4017807226812	IP44	
423	6101011-01	4017807017557	IP20	9218-01	376	622714007	4017807226805	IP44	
423	6101011-07	4017807028393	IP20	9218-01	425	622811528	4017807262407	IP20	92686
424	6102021-24	4017807053296	IP20	92126	92	623210242	4017807460070	IP20	
230	610300428	4017807369175	IP20		92	623210442	4017807460032	IP20	
212	610400431	4017807465747	IP20		236	623710130	4017807451184	IP20	
212	610400432	4017807465761	IP20		387	623810431	4017807399806	IP20	
416	6105011-01	4017807053968	IP20	9285-01	429	624110279	4017807337051	IP20	92795
416	6105021-01	4017807098440	IP20	9287-01	429	624110289	4017807337068	IP20	92795
417	6107011-07	4017807028041	IP20	9231	388	624410306	4017807353952	IP20	
417	6107021-07	4017807080704	IP20	92151	100	624610131	4017807472905	IP20	
162	611210506	4017807367782	IP20	92829-40 92833-10 92833-12 92833-14	100	624610132	4017807470918	IP20	
595	612400501	4017807411614	IP20		102	624610179	4017807470925	IP20	
597	612400507	4017807411638	IP20		612	624830307	4017807257724	IP20	98249 98248
597	612400524	4017807411645	IP20		612	624830328	4017807257892	IP20	98249 98248
595	612400532	4017807411621	IP20		82	625010105	4017807422641	IP20	
380	612900131	4017807426441	IP20		82	625010132	4017807422658	IP20	
380	612900132	4017807426465	IP20		413	625501231	4017807430349	IP20	
380	612900231	4017807426526	IP20		413	625501287	4017807434903	IP20	
380	612900232	4017807426533	IP20		413	625501831	4017807430356	IP20	
380	612900431	4017807426588	IP20		413	625501887	4017807434910	IP20	
380	612900432	4017807426595	IP20		413	625502231	4017807430363	IP20	
380	613000131	4017807426908	IP20		413	625502287	4017807434927	IP20	
380	613000132	4017807426915	IP20		412	625601231	4017807430288	IP20	
380	613000231	4017807426922	IP20		412	625601287	4017807434941	IP20	
380	613000232	4017807426939	IP20		412	625601831	4017807430295	IP20	
380	613000431	4017807426977	IP20		412	625601887	4017807434958	IP20	
380	613000432	4017807426984	IP20		412	625602231	4017807430301	IP20	
422	6160011-00	4017807131895	IP20	9516	412	625602287	4017807434965	IP20	
422	6196011-01	4017807138238	IP20	9523-01	84	625710207	4017807473223	IP20	
422	6196011-07	4017807138245	IP20	9523-07	84	625710231	4017807473230	IP20	
354	620010407	4017807449525	IP20		84	625710242	4017807473247	IP20	
354	620010431	4017807452204	IP20		406	626510901	4017807245196	IP20	
354	620010442	4017807449495	IP20		406	626510987	4017807245202	IP20	
389	620210206	4017807392449	IP20		406	626511201	4017807245219	IP20	
116	621210107	4017807453980	IP20		406	626511287	4017807245226	IP20	
					406	626512501	4017807246797	IP20	

Seite Page	Artikel-Nr. Product No.	EAN-Nummer EAN-Number	IP IP	Ersatzteile Spare parts	Seite Page	Artikel-Nr. Product No.	EAN-Nummer EAN-Number	IP IP	Ersatzteile Spare parts
406	626512587	4017807246803	IP20		621	650510132	4017807378085	IP23	
405	627514000	4017807401837	IP20		620	650510306	4017807376838	IP23	
405	627516000	4017807401820	IP20		620	650510307	4017807376845	IP23	
95	627710432	4017807442182	IP20		620	650510331	4017807376852	IP23	
94	627710405	4017807451702	IP20		623	650610106	4017807376869	IP65	
94	627710532	4017807448184	IP20		623	650610107	4017807376876	IP65	
94	627710505	4017807451658	IP20		623	650610131	4017807376890	IP65	
135	628290506	4017807259834	IP20		623	650610132	4017807442595	IP65	
394	628313001	4017807348002	IP20		622	650610306	4017807376906	IP65	
402	628513001	4017807298819	IP20		622	650610307	4017807376913	IP65	
402	628613001	4017807298826	IP20		622	650610331	4017807376920	IP65	
403	628898000	4017807357875	IP20		623	650710106	4017807376937	IP65	
401	628915001	4017807272307	IP20		623	650710107	4017807376944	IP65	
394	629010101	4017807381511	IP20		623	650710131	4017807376951	IP65	
107	629010107	4017807423426	IP20		623	650710132	4017807442601	IP65	
106	629010132	4017807423419	IP20		622	650710306	4017807376975	IP65	
657	629510101	4017807256819	IP65		622	650710307	4017807376968	IP65	
637	650000106	4017807376210	IP20		622	650710331	4017807376982	IP65	
637	650000107	4017807376234	IP20		46	650810507	4017807415094	IP20	92893
637	650000108	4017807376241	IP20						92894
637	650000131	4017807376203	IP20						92895
637	650000132	4017807378061	IP20		627	650910106	4017807376999	IP44	
636	650000306	4017807376258	IP20		627	650910107	4017807377002	IP44	
636	650000307	4017807376265	IP20		627	650910131	4017807377019	IP44	
636	650000331	4017807376272	IP20		50	651110207	4017807425291	IP20	
637	650100106	4017807376302	IP20		50	651110232	4017807425314	IP20	
637	650100107	4017807376319	IP20		57	651210507	4017807389753	IP20	
637	650100108	4017807376326	IP20		463	651300101	4017807409680	IP20	
637	650100131	4017807376296	IP20		463	651400101	4017807409697	IP20	
637	650100132	4017807378078	IP20		635	651500131	4017807455915	IP20	
636	650100306	4017807376333	IP20		635	651500132	4017807455939	IP20	
636	650100307	4017807376340	IP20		635	651600131	4017807455946	IP20	
636	650100331	4017807376357	IP20		635	651600132	4017807455977	IP20	
625	650210106	4017807376388	IP20		634	651600231	4017807456011	IP20	
625	650210107	4017807376395	IP20		634	651600232	4017807455991	IP20	
625	650210131	4017807376371	IP20		634	651600331	4017807456035	IP20	
624	650210306	4017807376418	IP20		634	651600332	4017807456059	IP20	
624	650210307	4017807376425	IP20		632	651700152	4017807425888	IP20	
624	650210331	4017807376432	IP20		632	651800152	4017807425901	IP20	
625	650310106	4017807376463	IP20		62	651914001	4017807389609	IP20	
625	650310107	4017807376470	IP20		62	651915501	4017807389616	IP20	
625	650310131	4017807376456	IP20		633	652100152	4017807425925	IP20	
624	650310306	4017807376494	IP20		633	652200152	4017807425949	IP20	
624	650310307	4017807376500	IP20		629	652310106	4017807427660	IP20	
624	650310331	4017807376517	IP20		629	652310131	4017807427677	IP20	
620	650410106	4017807376630	IP23		629	652410106	4017807427684	IP20	
621	650410107	4017807376647	IP23		629	652410131	4017807427691	IP20	
621	650410131	4017807376623	IP23		631	652510106	4017807427707	IP20	
621	650410132	4017807378030	IP23		631	652510131	4017807427714	IP20	
620	650410306	4017807376661	IP23		631	652610106	4017807427721	IP20	
620	650410307	4017807376678	IP23		631	652610131	4017807427738	IP20	
620	650410331	4017807376685	IP23		48	652610307	4017807453881	IP20	
621	650510106	4017807376753	IP23		48	652610342	4017807453751	IP20	
621	650510107	4017807376760	IP23		49	652690307	4017807453898	IP20	
621	650510131	4017807376722	IP23		48	652690342	4017807453768	IP20	

Seite Page	Artikel-Nr. Product No.	EAN-Nummer EAN-Number	IP IP	Ersatzteile Spare parts	Seite Page	Artikel-Nr. Product No.	EAN-Nummer EAN-Number	IP IP	Ersatzteile Spare parts
44	652710307	4017807453799	IP20		655	659412406	4017807280074	IP44	
44	652710342	4017807473339	IP20		376	659513605	4017807267235	IP20	
52	652810331	4017807469189	IP20		88	670410231	4017807435108	IP20	
52	652810332	4017807469196	IP20		88	670410331	4017807435115	IP20	
52	652810531	4017807472929	IP20		122	670910606	4017807330687	IP20	
52	652810532	4017807472936	IP20		78	671310105	4017807445329	IP20	
384	652910131	4017807473643	IP20		78	671310142	4017807445312	IP20	
384	652910132	4017807473650	IP20		78	671310131	4017807451832	IP20	
384	652910231	4017807473667	IP20		607	671510507	4017807285000	IP20	92739
384	652910232	4017807473674	IP20		128	671610307	4017807391237	IP20	
384	652910331	4017807473681	IP20		128	671610331	4017807391244	IP20	
384	652910332	4017807473698	IP20		340	671710442	4017807466959	IP20	
58	656010100	4017807389845	IP20		340	671710742	4017807466867	IP20	
58	656010101	4017807389838	IP20		341	671710479	4017807466935	IP20	
56	656090100	4017807389869	IP20		341	671710779	4017807466881	IP20	
56	656090101	4017807389852	IP20		131	672212405	4017807297553	IP20	
414	656211800	4017807372007	IP20	92834-40	90	672610331	4017807377477	IP20	
414	656311800	4017807371970	IP20		352	672610332	4017807441208	IP20	
408	656411506	4017807371796	IP44		386	672710407	4017807352733	IP20	
408	656412406	4017807371802	IP44		120	672910106	4017807299274	IP20	
408	656413006	4017807371819	IP44		414	673012489	4017807337464	IP20	92811-40
409	656511806	4017807371826	IP44		351	673210206	4017807388398	IP20	
409	656512006	4017807371833	IP44		350	673210231	4017807388404	IP20	
409	656513006	4017807371840	IP44		351	673210306	4017807388411	IP20	
411	657010601	4017807294637	IP20		350	673210331	4017807388428	IP20	
411	657010607	4017807294675	IP20		353	673210332	4017807441192	IP20	
411	657011201	4017807294712	IP20		364	673311106	4017807351651	IP20	
411	657011207	4017807294729	IP20		365	673311306	4017807358407	IP20	
411	657011801	4017807294743	IP20		415	673411201	4017807342253	IP20	92790
411	657011807	4017807294750	IP20		415	673611201	4017807342277	IP20	92792
410	657110601	4017807294651	IP20		366	673810206	4017807433333	IP20	
410	657110607	4017807294668	IP20		366	673810232	4017807433364	IP20	
410	657111201	4017807294705	IP20		366	673890206	4017807433371	IP20	
410	657111207	4017807294699	IP20		366	673890232	4017807433388	IP20	
410	657111801	4017807294767	IP20		348	673916007	4017807452594	IP20	
410	657111807	4017807294774	IP20		348	673916031	4017807452235	IP20	
55	657411107	4017807436358	IP20		348	673916032	4017807441437	IP20	
54	657413007	4017807436341	IP20		348	673918007	4017807452617	IP20	
55	657414007	4017807434521	IP20		348	673918031	4017807452259	IP20	
55	657416007	4017807434552	IP20		348	673918032	4017807441468	IP20	
54	657493007	4017807436334	IP20		375	674011207	4017807363708	IP20	
54	657494007	4017807434415	IP20		374	674013007	4017807363630	IP20	
54	657496007	4017807434439	IP20		374	674014507	4017807363654	IP20	
404	657810100	4017807351064	IP20		375	674016207	4017807363692	IP20	
404	657910100	4017807351101	IP20		374	674093007	4017807363623	IP20	
60	658210107	4017807389760	IP20		374	674094507	4017807363647	IP20	
60	658210131	4017807389777	IP20		374	674096207	4017807363685	IP20	
407	658311401	4017807300932	IP20		372	674110687	4017807393613	IP20	
407	658312601	4017807300949	IP20		372	674110887	4017807393620	IP20	
407	658611407	4017807300918	IP20		372	674111187	4017807393637	IP20	
58	658810100	4017807389883	IP20		386	674312406	4017807285925	IP20	
58	658810101	4017807389876	IP20		358	674410307	4017807455854	IP20	
654	659011801	4017807280081	IP44		359	674410331	4017807477108	IP20	
654	659011887	4017807280098	IP44		358	674410342	4017807455847	IP20	
655	659411806	4017807280050	IP44		343	674510107	4017807381566	IP20	

Seite Page	Artikel-Nr. Product No.	EAN-Nummer EAN-Number	IP IP	Ersatzteile Spare parts
360	674610507	4017807385786	IP20	
361	674610707	4017807450224	IP20	
360	674610531	4017807457872	IP20	
361	674610731	4017807454871	IP20	
346	674814005	4017807414813	IP20	
346	674816005	4017807414837	IP20	
344	675010101	4017807358957	IP20	
345	675090101	4017807358964	IP20	92849
96	675510507	4017807455779	IP20	
99	675510531	4017807455755	IP20	
96	675510532	4017807455762	IP20	
395	675610106	4017807363302	IP20	
390	675710200	4017807456349	IP20	
390	675719200	4017807456363	IP20	
356	676210307	4017807371918	IP20	
357	676210342	4017807425703	IP20	
356	676210407	4017807425734	IP20	
357	676210442	4017807425758	IP20	
356	676290307	4017807371925	IP20	
118	676310206	4017807298925	IP20	
125	676412406	4017807287264	IP20	
125	676413606	4017807281620	IP20	
370	676611031	4017807398533	IP20	
370	676615031	4017807398519	IP20	
370	676617531	4017807398526	IP20	
369	677010307	4017807382020	IP20	
368	677010379	4017807380514	IP20	
368	677010507	4017807382037	IP20	
368	677010579	4017807380521	IP20	
369	677010607	4017807382044	IP20	
368	677010679	4017807380538	IP20	
376	677610106	4017807355345	IP20	92842
376	677690106	4017807355352	IP20	
401	677718000	4017807337686	IP20	92804
136	678010107	4017807401127	IP20	
136	678010108	4017807401134	IP20	
400	678513001	4017807431070	IP20	
400	678613001	4017807431087	IP20	
397	678710006	4017807337730	IP20	92864
397	678711206	4017807337716	IP20	
397	678713006	4017807337723	IP20	
378	679010031	4017807476422	IP20	
378	679015031	4017807476415	IP20	
378	679095031	4017807476408	IP20	
398	679112132	4017807471021	IP20	
398	679114232	4017807471045	IP20	
398	679110032	4017807471069	IP20	
393	679210106	4017807440348	IP20	
363	679511531	4017807450712	IP20	
362	679511532	4017807450767	IP20	
392	679710506	4017807435092	IP20	
656	6801011-01	4017807259056	IP44	
656	6801011-06	4017807147575	IP44	9580
656	6801011-07	4017807147582	IP44	9580
642	682410506	4017807280845	IP44	

Seite Page	Artikel-Nr. Product No.	EAN-Nummer EAN-Number	IP IP	Ersatzteile Spare parts
646	683310306	4017807391848	IP44	92888
646	683310307	4017807384192	IP44	92888
151	693900417	4017807409451	IP20	S693915-11 S693920-02 S693925-01 S693930-01
151	693900517	4017807399547	IP20	S693920-11 S693925-02 S693930-02 S693935-01 S693940-01
564	700131	4017807470161	IP20	
564	700132	4017807470178	IP20	
564	700187	4017807470246	IP20	
564	700231	4017807470277	IP20	
564	700232	4017807470307	IP20	
564	700287	4017807470253	IP20	
565	701031	4017807470321	IP20	
565	701032	4017807470338	IP20	
565	701087	4017807470345	IP20	
565	701131	4017807474824	IP20	
565	701132	4017807474831	IP20	
565	701187	4017807474848	IP20	
565	701231	4017807470352	IP20	
565	701232	4017807470369	IP20	
565	701287	4017807470376	IP20	
567	702031	4017807470383	IP20	
567	702032	4017807470390	IP20	
567	702087	4017807470406	IP20	
566	702131	4017807470475	IP20	
566	702132	4017807470482	IP20	
566	702187	4017807470499	IP20	
566	702231	4017807470505	IP20	
566	702232	4017807470543	IP20	
566	702231A	4017807474855	IP20	
566	702232A	4017807474862	IP20	
566	702287	4017807470550	IP20	
566	702287A	4017807474879	IP20	
567	702331	4017807470567	IP20	
567	702332	4017807470574	IP20	
567	702331A	4017807482171	IP20	
567	702332A	4017807482188	IP20	
567	702387	4017807470581	IP20	
567	702387A	4017807482195	IP20	
567	702431	4017807470598	IP20	
567	702432	4017807470604	IP20	
567	702487	4017807470611	IP20	
568	702531	4017807470628	IP20	
568	702532	4017807470635	IP20	
568	702587	4017807470642	IP20	
569	703031	4017807471397	IPX0	
569	703032	4017807471403	IPX0	
569	703087	4017807471410	IPX0	
568	703131	4017807471427	IPX0	
568	703132	4017807471434	IPX0	

Seite Page	Artikel-Nr. Product No.	EAN-Nummer EAN-Number	IP IP	Ersatzteile Spare parts	Seite Page	Artikel-Nr. Product No.	EAN-Nummer EAN-Number	IP IP	Ersatzteile Spare parts
568	703187	4017807471441	IPX0		592	800600231	4017807446272	IP20	
568	703231	4017807471458	IPX0		592	800600232	4017807451740	IP20	
568	703232	4017807471465	IPX0		592	800600431	4017807446296	IP20	
568	703287	4017807471472	IPX0		592	800600432	4017807451788	IP20	
569	703331	4017807471489	IP20		592	800690331	4017807446289	IP20	
569	703332	4017807471502	IP20		592	800690332	4017807451764	IP20	
569	703387	4017807471519	IP20		590	800700107	4017807469103	IP20	
568	703431	4017807474886	IPX0		590	800700131	4017807469127	IP20	
569	703531	4017807474893	IPX0		590	800700132	4017807469141	IP20	
569	703532	4017807474909	IPX0		590	800700207	4017807469165	IP20	
569	703587	4017807474916	IPX0		590	800700231	4017807469202	IP20	
568	703952	4017807471533	IP20		590	800700232	4017807469226	IP20	
571	73120102	4017807471557	IP20		590	800700307	4017807469264	IP20	
572	73240107	4017807471564	IP20		590	800700331	4017807469288	IP20	
572	73240131	4017807471571	IP20		590	800700332	4017807469301	IP20	
572	73240132	4017807471588	IP20		590	800700407	4017807469325	IP20	
570	73330101	4017807471595	IP20		590	800700431	4017807469349	IP20	
570	73330111	4017807471618	IP20		590	800700432	4017807469363	IP20	
571	73520101	4017807471656	IP20		198	801500107	4017807388824	IP20	
570	76390201	4017807472110	IP20		198	801500207	4017807388831	IP20	
570	76390211	4017807472127	IP20		198	801500307	4017807388848	IP20	
589	770010587	4017807287196	IP20		198	801500407	4017807388855	IP20	
573	77020131	4017807472028	IP20		594	802400101	4017807227543	IP20	
573	77020132	4017807472035	IP20		596	802400107	4017807231335	IP20	
573	77020187	4017807472042	IP20		596	802400124	4017807408621	IP20	
586	775910506	4017807285994	IP20		594	802400132	4017807408614	IP20	
586	777710506	4017807305050	IP20		594	802400201	4017807227550	IP20	
589	778210506	4017807281576	IP20		597	802400207	4017807231359	IP20	
586	779310707	4017807336900	IP20		597	802400224	4017807408645	IP20	
571	78010107	4017807471946	IP20		594	802400232	4017807408638	IP20	
571	78010131	4017807471922	IP20		594	802400301	4017807227567	IP20	
571	78010132	4017807471939	IP20		597	802400307	4017807231373	IP20	
571	78070107	4017807472073	IP20		597	802400324	4017807408669	IP20	
571	78070131	4017807472080	IP20		594	802400332	4017807408652	IP20	
571	78070132	4017807472103	IP20		594	802430401	4017807227574	IP20	
571	78170107	4017807471663	IP20		597	802430407	4017807231397	IP20	
572	78240107	4017807471694	IP20		597	802430424	4017807408683	IP20	
572	78240131	4017807471700	IP20		594	802430432	4017807408676	IP20	
572	78240132	4017807471724	IP20		600	802500178	4017807299519	IP20	
571	78330101	4017807471977	IP20		600	802500278	4017807299526	IP20	
571	78330111	4017807471991	IP20		600	802500378	4017807299540	IP20	
571	78330179	4017807472295	IP20		601	802530478	4017807353808	IP20	
617	800300132	4017807351392	IP20		604	803000107	4017807348262	IP20	
617	800300232	4017807351415	IP20		604	803000207	4017807348279	IP20	
617	800300432	4017807351644	IP20		604	803000307	4017807348286	IP20	
608	800500404	4017807422610	IP20		604	803000407	4017807348309	IP20	
608	800500407	4017807422603	IP20		605	803000607	4017807348293	IP20	
608	800570104	4017807427318	IP20		604	803080107	4017807348330	IP20	
608	800570107	4017807427332	IP20		605	803090307	4017807348323	IP20	
608	800570204	4017807427356	IP20		614	803100104	4017807353235	IP20	92812-01
608	800570207	4017807427370	IP20		614	803100107	4017807353242	IP20	92812-01
608	800590304	4017807422597	IP20		614	803100204	4017807353259	IP20	92812-01
608	800590307	4017807422580	IP20		614	803100207	4017807353266	IP20	92812-01
592	800600131	4017807446265	IP20		614	803100304	4017807353273	IP20	92812-01
592	800600132	4017807451726	IP20		614	803100307	4017807353280	IP20	92812-01

Seite Page	Artikel-Nr. Product No.	EAN-Nummer EAN-Number	IP IP	Ersatzteile Spare parts	Seite Page	Artikel-Nr. Product No.	EAN-Nummer EAN-Number	IP IP	Ersatzteile Spare parts
614	803100404	4017807353297	IP20	92812-01	612	824810328	4017807257823	IP20	98249
614	803100407	4017807353303	IP20	92812-01					98248
244	803400167	4017807430196	IP20		612	824810407	4017807257588	IP20	98249
244	803400267	4017807430202	IP20						98248
244	803400367	4017807430219	IP20		612	824810428	4017807257830	IP20	98249
598	803500131	4017807408201	IP20	S8035-02					98248
598	803500132	4017807408225	IP20	S8035-02	584	827830431	4017807383843	IP20	S8278-01
598	803500231	4017807408232	IP20	S8035-02	584	827830432	4017807383850	IP20	S8278-01
598	803500232	4017807408249	IP20	S8035-02	584	827890131	4017807383751	IP20	S8278-01
598	803500331	4017807408256	IP20	S8035-02	584	827890132	4017807383768	IP20	S8278-01
598	803500332	4017807408263	IP20	S8035-02	584	827890231	4017807383782	IP20	S8278-01
598	803590431	4017807408294	IP20	S8035-02	584	827890232	4017807383799	IP20	S8278-01
598	803590432	4017807408300	IP20	S8035-02	584	827890331	4017807383812	IP20	S8278-01
147	803600207	4017807451016	IP20	S8036-11	584	827890332	4017807383829	IP20	S8278-01
146	803600232	4017807451009	IP20	S8036-44	576	828510307	4017807378238	IP20	
146	803600307	4017807451047	IP20	S8036-11	576	828510331	4017807378221	IP20	
146	803600332	4017807451030	IP20	S8036-44	576	828510407	4017807378252	IP20	
147	803670107	4017807450989	IP20	S8036-11	576	828510431	4017807378245	IP20	
146	803670132	4017807450972	IP20	S8036-44	576	828510507	4017807378276	IP20	
256	804300332	4017807467666	IP20		576	828510531	4017807378269	IP20	
256	804300432	4017807467680	IP20		576	828530507	4017807378290	IP20	
256	804370132	4017807467604	IP20		576	828530531	4017807378283	IP20	
256	804370232	4017807467642	IP20		576	828570207	4017807378214	IP20	
248	805000130	4017807353730	IP20		576	828570231	4017807378207	IP20	
248	805000230	4017807353747	IP20		68	850110231	4017807408379	IP20	
248	805000330	4017807353754	IP20		68	850110232	4017807408416	IP20	
248	805000430	4017807353761	IP20		68	850110431	4017807408393	IP20	
246	805300188	4017807445183	IP20		68	850110432	4017807408423	IP20	
246	805300288	4017807445190	IP20		68	850190331	4017807408386	IP20	
246	805300388	4017807445206	IP20		68	850190332	4017807408430	IP20	
246	805300488	4017807445213	IP20		610	871010107	4017807281637	IP20	92734
196	805600106	4017807406801	IP20		610	871010108	4017807281644	IP20	92734
196	805600206	4017807406825	IP20		610	871010207	4017807281651	IP20	92734
196	805600306	4017807406849	IP20		610	871010208	4017807281668	IP20	92734
196	805600406	4017807406856	IP20		610	871010307	4017807281675	IP20	92734
602	818000206	4017807203059	IP20		610	871010308	4017807281682	IP20	92734
602	818000306	4017807203066	IP20		610	871010407	4017807281712	IP20	92734
602	818070106	4017807203042	IP20		610	871010408	4017807281729	IP20	92734
578	821410305	4017807220902	IP20	92426	611	871010607	4017807281736	IP20	92734
578	821410405	4017807220919	IP20	92426	611	871010608	4017807281743	IP20	92734
578	821410605	4017807220933	IP20	92426	610	871090307	4017807281699	IP20	92734
579	821430405	4017807220926	IP20	92426	610	871090308	4017807281705	IP20	92734
578	821470105	4017807220889	IP20	92426	616	871410107	4017807261820	IP20	92680
578	821470205	4017807220896	IP20	92426	616	871410207	4017807261837	IP20	92680
612	824810107	4017807257526	IP20	98249	616	871410307	4017807261844	IP20	92680
				98248	616	871410407	4017807261851	IP20	92680
612	824810128	4017807257809	IP20	98249	606	871510207	4017807284904	IP20	92739
				98248	606	871510407	4017807284966	IP20	92739
612	824810207	4017807257540	IP20	98249	606	871510607	4017807284980	IP20	92739
				98248	606	871570107	4017807284898	IP20	92739
612	824810228	4017807257816	IP20	98249	606	871590307	4017807284942	IP20	92739
				98248	580	873110307	4017807302615	IP20	
612	824810307	4017807257564	IP20	98249	582	873110331	4017807302622	IP20	
				98248	580	873110407	4017807302639	IP20	
					582	873110431	4017807302646	IP20	

Seite Page	Artikel-Nr. Product No.	EAN-Nummer EAN-Number	IP IP	Ersatzteile Spare parts	Seite Page	Artikel-Nr. Product No.	EAN-Nummer EAN-Number	IP IP	Ersatzteile Spare parts
580	873110607	4017807302653	IP20		661	983-4470	4017807358940	IPX0	
582	873110631	4017807302660	IP20		662	983-56	4017807394863	IPX0	
580	873170107	4017807302578	IP20		662	983-60	4017807279214	IPX0	
582	873170131	4017807302585	IP20		662	983-63	4017807279221	IPX0	
580	873170207	4017807302592	IP20		660	983-66	4017807300345	IPX0	
582	873170231	4017807302608	IP20		73	983-88	4017807388367	IPX0	
471	891010107	4017807358049	IP20	92734	661	985-6810	4017807358759	IPX0	
470	8911211-07	4017807118780	IP20		662	986-40	4017807268782	IPX0	
470	891770107	4017807358162	IP20	92816	662	986-43	4017807268799	IPX0	
470	899670107	4017807358155	IP20		662	986-60	4017807280647	IPX0	
665	901-454	4017807412666	IPX0		662	986-63	4017807280654	IPX0	
665	901-479	4017807351446	IPX0		661	986-6810	4017807358766	IPX0	
665	902-454	4017807412680	IPX0		664	986-710	4017807433463	IP20	
665	902-479	4017807351453	IPX0		664	987-2400	4017807303933	IPX0	
665	903-454	4017807412703	IPX0		664	987-400	4017807287509	IPX0	
665	903-479	4017807351460	IPX0		664	987-410	4017807394917	IPX0	
665	904-454	4017807412727	IPX0		662	987-60	4017807279252	IPX0	
665	904-479	4017807351477	IPX0		664	987-600	4017807288056	IPX0	
665	905-454	4017807412741	IPX0		664	987-679	4017807288049	IPX0	
665	905-479	4017807351484	IPX0		661	987-6700	4017807387636	IPX0	
666	906-854	4017807407334	IPX0		661	987-6810	4017807358735	IPX0	
666	906-879	4017807382655	IPX0		73	987-88	4017807388374	IPX0	
666	907-854	4017807407341	IPX0		660	988-10	4017807300338	IPX0	
666	907-879	4017807382662	IPX0		662	988-110	4017807394894	IPX0	
666	908-854	4017807407358	IPX0		664	988-600	4017807287516	IPX0	
666	908-879	4017807382716	IPX0		665	988-654	4017807416220	IPX0	
663	929-220	4017807293319	IPX0		665	988-679	4017807287530	IPX0	
660	929-230	4017807355000	IPX0		662	988-700	4017807394887	IPX0	
663	929-2300	4017807394924	IPX0		664	988-710	4017807433449	IP20	
455	92805	4017807362640	IPX0		662	989-40	4017807240597	IPX0	
250	92945	4017807478174	IPX0		664	989-400	4017807287486	IPX0	
663	955-50	4017807277074	IPX0		662	989-43	4017807260557	IPX0	
663	955-55	4017807277098	IPX0		661	989-4470	4017807358926	IPX0	
663	956-30	4017807277050	IPX0		664	989-479	4017807287523	IPX0	
660	956-55	4017807300369	IPX0		662	989-56	4017807394870	IPX0	
660	956-5736	4017807380057	IPX0		662	989-60	4017807279238	IPX0	
663	956-5936	4017807380071	IPX0		662	989-63	4017807279245	IPX0	
73	956-88	4017807388350	IPX0		660	989-66	4017807300352	IPX0	
662	983-40	4017807240566	IPX0		662	990-40	4017807240610	IPX0	
664	983-400	4017807302097	IPX0		664	990-400	4017807287493	IPX0	
664	983-410	4017807394900	IPX0		661	990-4470	4017807358933	IPX0	
662	983-43	4017807260540	IPX0						

TRIO behält sich das Recht vor, zu jeder Zeit, notwendige Änderungen oder Aktualisierungen der in diesem Katalog enthaltenen Produkte vorzunehmen. · TRIO reserves the right to carry out any time, necessary changes or updates of the products in this catalogue. · TRIO se réserve le droit d'apporter à tout moment les modifications ou actualisations nécessaires aux produits dans ce catalogue. · TRIO behoudt zich het recht voor op ieder moment noodzakelijke wijzigingen of updates aan de producten in deze catalogus door te voeren. · TRIO se reserva , en todo momento, el derecho a realizar las modificaciones o actualizaciones que considere necesarias para cualquier producto de este catálogo. · TRIO si riserva il diritto di apportare, in qualunque momento, tutte le modifiche necessarie ai prodotti di questo catalogo. · TRIO-ul își rezervă dreptul de a face oricând orice modificări sau actualizări necesare pentru produsele din acest catalog. · TRIO pidättää oikeuden tehdä muutoksia tai päivittää tuotteita tässä luettelossa. · TRIO zastrzega sobie prawo do wprowadzania w dowolnym czasie zmian lub aktualizacji produktów zawartych w katalogu.

Kontakte

Contact · Contact · Contact · Contactar · Contatto · Contact · Yhteydenotto · Kontakt

TRIO Leuchten GmbH

Gut Nierhof 17
D-59757 Arnsberg

T +49 2931 9666-0
F +49 2931 9666-57

info@trio-leuchten.de
www.trio-leuchten.de



Niedersachsen, Schleswig-Holstein

Jens Gebers

T +49 170 1615227
jens.gebers@trio-leuchten.de



Österreich

Wolfgang Melich

T +43 660 5161228
wolfgang.melich@trio-leuchten.de

Nordrhein-Westfalen

Antonio Capizzi

T +49 172 2598392
capizziantonio@aol.com



Schweiz

TRIO Leuchten GmbH

T +49 2931 9666-0
info@trio-leuchten.de

Saarland, Rheinland-Pfalz, Hessen

Christian Teller

T +49 171 4521820
christian.teller@trio-leuchten.de

Baden Württemberg

Antonio De Simone

T +49 151 58555222
antonio.desimone@trio-leuchten.de

Bayern, Hessen

Martin Kluge

T +49 171 7300330
martin.kluge@trio-leuchten.de

Berlin, Brandenburg, Meckl.-Vorpommern, Sachsen, Sachsen Anhalt, Thüringen

Jörg Bumke

T +49 160 7406860
joerg.bumke@trio-leuchten.de

 @trioleuchten

 /trioleuchten

 @trio.lighting



TRIO International GmbH

Gut Nierhof 17
D-59757 Arnsberg

T +49 2931 9666-587
F +49 2931 9666-56

info@trio-lighting.com
www.trio-lighting.com



France

Stéphane Papierny

Directeur Commercial France
info.france@trio-lighting.com

Jean Philippe Bailly

info.france@trio-lighting.com
Agent exclusif pour les départements
60, 75001-75004, 75008-75010,
75017-75019, 92, 93, 95

Jean Barel

info.france@trio-lighting.com
Agent exclusif pour les départements
09, 12, 15, 16, 19, 23, 24, 31, 32, 33, 40, 46,
47, 64, 65, 81, 82 et 87

Nina & Richard Lecoiffier

info.france@trio-lighting.com
Agents exclusifs pour les départements
27, 28, 76

Antoine Masu

info.france@trio-lighting.com
Agent exclusif pour les départements
2a et 2b

Christophe Meulien

info.france@trio-lighting.com
Agent exclusif pour les départements
04, 05, 06, 11, 13, 30, 34, 66, 83 et 84

Stéphane Riebel

info.france@trio-lighting.com
Agent exclusif pour les départements
18, 45, 58, 75005-75007, 75011-75016,
75020, 77, 78, 89, 91, 94

Michel Salamand

info.france@trio-lighting.com
Agent exclusif pour les départements
14, 17, 22, 29, 35, 36, 37, 41, 44, 49, 50, 53,
56, 61, 72, 79, 85 et 86

Vincent Zaepffel

info.france@trio-lighting.com
Commercial pour les départements
02, 08, 10, 25, 51, 52, 54, 55, 57, 59, 62,
67, 68, 70, 80, 88 et 90

Sullivan Nicolas

info.france@trio-lighting.com
Agent exclusif pour les départements
01, 03, 07, 21, 26, 38, 39, 42, 43, 48, 63, 69,
71, 73 et 74



Suomi

TRIO Lighting Scandinavia Oy

Malmin raitti, rappu 17 B
00700 Helsinki

T +358 (0) 10 23 13 390

F +358 (0) 10 23 13 399

info.scandinavia@trio-lighting.com

Our Scandinavian organisation represents TRIO
also in DENMARK, SWEDEN, NORWAY, ESTONIA,
LATVIA and LITHUANIA



Great Britain

TRIO Lighting UK Ltd.

Unit 5, Hemmells Park Hemmells, Laindon
Essex

SS1s 6GF

T +44 (0) 12 68 88 95 95

F +44 (0) 12 68 88 95 96

sales@trio-lightinguk.com



Nederland

Karl Stok / Bas Martin

info.nederland@trio-lighting.com



Belgium/Belgique

Yves van den Berghe

info.belgium@trio-lighting.com



Italia

TRIO Lighting Italia s.r.l

Via Padre Masciadri, 2 H
IT-22066 Mariano Comense (CO)

T +39 (0) 317 477 55

F +39 (0) 313 551 560

commerciale@trio-lighting.com



España

Trio Lighting Ibèrica SL

C/ Can Lietget n°9 nave9

Pol. Ind. Can Roqueta

08206 Sabadell

T +34 (0) 9 35 45 86 30

F +34 (0) 9 33 96 45 48

E-Mail: info.iberica@trio-lighting.com



Romania

Gina Ionita

info.romania@trio-lighting.com

lichtforumnrw

www.lichtforumnrw.de

LICHTWOCHE
SAUERLAND
28.02. - 05.03.2021





TRIO Leuchten GmbH

Gut Nierhof 17
D-59757 Arnsberg

T +49 2931 9666-0
F +49 2931 9666-28

info@trio-leuchten.de
www.trio-leuchten.de

TRIO International GmbH

Gut Nierhof 17
D-59757 Arnsberg

T +49 2931 9666-587
F +49 2931 9666-56

info@trio-lighting.com
www.trio-lighting.com

